



# Technical Service BULLETIN

November 28, 2005

Title:

## 2006 MY PRIUS PRE-DELIVERY SERVICE (PDS)

Models:

'06 Prius

# TSB

PRE-DELIVERY SERVICE  
PD089-05

**Introduction** Pre-Delivery Service (PDS) is a critical step in satisfying your dealership's new car customers. Customer feedback indicates the following areas deserve special attention when performing PDS:

- Careful inspection for paint chips/scratches and body dents/dings.
- Proper operation of electrical accessories (including interior light, clock, and radio reset).
- Interior cleanliness.
- Proper function of mechanical systems.

For improved customer satisfaction, please pay particular attention to the Fuse Installation, Battery Maintenance, and other procedures indicated in bold red type.

For additional PDS detail, please see related PDS TSBs and the "Pre-Delivery Service Manual for Hybrid Vehicles" in the Technical Information System (TIS).

**Precautions** The Prius has unique operating modes, so always follow the precautions below when performing the PDS operation:

- The Prius contains high voltage (200 ~ 500 volts) AC and DC systems. All high-voltage wiring and connections are orange in color. Do NOT carelessly touch these orange-colored wiring harnesses and connectors.
- The gasoline engine may start up and shut down suddenly whenever the "READY" light is illuminated. **Be sure to press the "P" position switch, apply the parking brake, press the "POWER" switch in order to stop the hybrid system (the "READY" light is OFF), and remove the ignition key before working in the engine compartment.**
- The hybrid transaxle, engine radiator, and inverter radiator may reach high temperatures during inspection. Carefully observe all caution labels and instructions on these components.
- Be sure to place the shift selector into "P" (press the "P" switch) at all times unless otherwise instructed. When the shift selector is in the "N" position, the hybrid vehicle battery will NOT charge even if the gasoline engine is operating.
- When leaving the vehicle, press the "P" position switch, apply the parking brake, and press the "POWER" switch in order to stop the hybrid system (the "READY" light is OFF). Remove the ignition key.
- Air vents are provided on the package tray behind the rear seatback to cool the hybrid vehicle battery. Do NOT block these air vents.
- Do NOT splash water on the electric components in the engine compartment.

### Reimbursement Information

OP CODE	DESCRIPTION	TIME	OFF	T1	T2
001013	Pre-Delivery Service (PDS)	1.6	N/A	-	-



**Warranty Policy** If the need for additional repairs or adjustment is noted during PDS, the required service should be performed under warranty. Reimbursement will be managed under the warranty policy.

***The Warranty Policy and Procedures Manual requires that you maintain the completed Prius PDS Check Sheet in the customer's file.*** If you cannot produce a completed form for each retailed vehicle upon TMS and/or Region/Distributor audit, the PDS payment amount will be subject to debit.

An additional Repair Order completed in conjunction with normal PDS must have time punch/flags for service. If multiple repairs are performed, separate time flags must be punched for each repair.

2006 Model  
Year PDS  
Check Sheet

 **TOYOTA PRIUS**  
**2006 PRE-DELIVERY SERVICE CHECK SHEET**

	OK	Adjust/Repair		OK	Adjust/Repair
<b>A. BEFORE INSPECTION</b>			<b>E. UNDER VEHICLE (ON HOIST)</b>		
01 <b>INSTALL DOME FUSE</b> .....	<input checked="" type="checkbox"/>		01 Remove disc brake anti-corrosion wheel film .....	<input type="checkbox"/>	
02 Install radio antenna .....	<input type="checkbox"/>		02 Install rubber body plugs .....	<input type="checkbox"/>	
<b>B. FUNCTIONAL OPERATION</b>			03 Inspect for fuel oil, coolant, and other fluid leaks .....		
<i>IMPORTANT: See Pre-Delivery Service TSB for details on startup methods for the hybrid system.</i>			04 Visually check bolts and nuts on chassis and powertrain for looseness .....		
01 Check power supply changeover and Smart Key system* .....	<input type="checkbox"/>	<input type="checkbox"/>	05 Inspect under the vehicle for damage, rust, etc. ....		
02 Check hybrid system start/stop .....	<input type="checkbox"/>	<input type="checkbox"/>	06 <b>Activate tire pressure monitor</b> .....		
03 Check hybrid vehicle Immobilizer system .....	<input type="checkbox"/>	<input type="checkbox"/>	07 Install wheel caps/covers .....		
04 Check warning/indicator lights, buzzers, gauges, and multi-information display .....	<input type="checkbox"/>	<input type="checkbox"/>	08 <b>Install front spoiler</b> .....		
05 Check windshield wipers and washers .....	<input type="checkbox"/>	<input type="checkbox"/>	09 <b>Install rear lower side spoiler set</b> .....		
06 Check headlights, instrument lights, dimmer switch, turn signals, emergency flashers, and brake lights .....	<input type="checkbox"/>	<input type="checkbox"/>	<b>F. ROAD TEST</b>		
07 Check inside/outside rear view mirror operation/adjustment .....	<input type="checkbox"/>	<input type="checkbox"/>	<i>A complete road test helps assure customer satisfaction. Drive vehicle over a variety of road surfaces and driving conditions. Check for unusual noise and driving performance.</i>		
08 Check power outlet .....	<input type="checkbox"/>	<input type="checkbox"/>	Enter Odometer Reading		
09 Check audio system and set clock .....	<input type="checkbox"/>	<input type="checkbox"/>	Reading Before Test _____		
10 Check dome, personal, courtesy, and sun visor lights .....	<input type="checkbox"/>	<input type="checkbox"/>	Reading After Test _____		
11 <b>Erase Diagnostic Trouble Codes (DTCs)</b> .....	<input type="checkbox"/>	<input type="checkbox"/>	01 Check vehicle operation at cold, at warm-up, and at normal operating temperatures .....		
<b>C. WALKAROUND INSPECTION</b>			02 Check hybrid transaxle operation .....		
<i>Start at left front door. Check window and door lock operation (from master power switch, if equipped). Continue around vehicle in a counterclockwise direction checking each door and window operation, child door locks, seat belts, interior condition, all lights, trunk contents. Remove rubber body plugs from glove box for installation during UNDER VEHICLE inspection.</i>			03 Check brake and parking brake operation .....		
01 Check power window operation .....	<input type="checkbox"/>	<input type="checkbox"/>	04 <b>Check steering operation and for steering wheel off-center</b> .....		
02 Check door and door lock operation .....	<input type="checkbox"/>	<input type="checkbox"/>	05 Check speedometer operation .....		
03 Check operation of wireless remote control system .....	<input type="checkbox"/>	<input type="checkbox"/>	06 Inspect for abnormal noise and vibration .....		
04 Check operation of Smart Entry & Start system* .....	<input type="checkbox"/>	<input type="checkbox"/>	07 Inspect for squeaks and rattles .....		
05 Check operation of theft deterrent system* .....	<input type="checkbox"/>	<input type="checkbox"/>	08 Check heater and A/C operation .....		
06 Check child safety door locks are in normal (unlocked) position .....	<input type="checkbox"/>	<input type="checkbox"/>	09 Check cruise control operation* .....		
07 Check seats and seat belt operation .....	<input type="checkbox"/>	<input type="checkbox"/>	10 Initialize Navigation system* .....		
08 Check rear defogger .....	<input type="checkbox"/>	<input type="checkbox"/>	<b>G. FINAL INSPECTION AND CLEANING</b>		
09 Check side marker, tail, backup, and license plate lights .....	<input type="checkbox"/>	<input type="checkbox"/>	01 Remove interior protective covers, unnecessary labels, tags, etc. (Remove protective covers just before delivery to the customer) .....		
10 Check trunk light and trunk trim appearance .....	<input type="checkbox"/>	<input type="checkbox"/>	02 Visually inspect all interior parts for installation, damage, fit, dirt, etc. ....		
11 Check spare tire pressure and jack and tool installation .....	<input type="checkbox"/>	<input type="checkbox"/>	03 Remove Rappgard™ protective film .....		
12 Check 12-volt auxiliary battery terminal tightness .....	<input type="checkbox"/>	<input type="checkbox"/>	04 Wash and clean vehicle .....		
13 <b>Check 12-volt auxiliary battery state-of-charge</b> .....	<input type="checkbox"/>	<input type="checkbox"/>	05 Inspect paint finish for scratches, chips, rust, dents, damage, etc. ....		
<b>D. UNDER HOOD</b>			06 Inspect exterior body parts for proper installation, damage, rust, etc. ....		
01 Check engine oil level .....	<input type="checkbox"/>	<input type="checkbox"/>	07 <b>Install front license plate mounting bracket and front license plate</b> .....		
02 Check brake fluid level .....	<input type="checkbox"/>	<input type="checkbox"/>	<b>H. BATTERY MAINTENANCE</b>		
03 Check engine coolant level .....	<input type="checkbox"/>	<input type="checkbox"/>	01 Perform HV battery check and maintenance .....		
04 Check inverter coolant level .....	<input type="checkbox"/>	<input type="checkbox"/>			
05 Check windshield washer fluid level .....	<input type="checkbox"/>	<input type="checkbox"/>			
06 Inspect for fuel, oil, coolant, and other fluid leaks .....	<input type="checkbox"/>	<input type="checkbox"/>			
COMMENTS					
Completion and retention of this form is required to comply with Toyota's Warranty Policy.					
TECHNICIAN'S SIGNATURE _____			SERVICE MANAGER'S SIGNATURE _____		
NAME (PLEASE PRINT) _____			NAME (PLEASE PRINT) _____		
Date	Dealer Name	Dealer Code	Vehicle Identification Number (Sticker)		

*We hereby certify that all items on this form have been checked and corrected for proper operation as required.*

\* Inspect or Install when Equipped/Required

Before Inspection

**A01. Install DOME fuse**

**A02. Install radio antenna**

The radio antenna is fixed on the roof.

Functional Operation

**B01. Check power supply changeover and Smart Key system\***

**HINT:**  
For details on the startup methods for hybrid systems, refer to the Owner's Manual.

1. Apply the parking brake.
2. Make sure the key is fully inserted into the key slot.
  
3. Without depressing the brake pedal, press the "POWER" switch and change the power supply.
  - Pressed once: the hybrid system is in the "ACC" position.
  - Pressed twice: the hybrid system is in the "IG-ON" position.
  - Pressed three times: the hybrid system is "OFF."

**HINT:**  
If the switch is pressed quickly, the power supply may NOT change. Make sure to fully press the "POWER" switch.

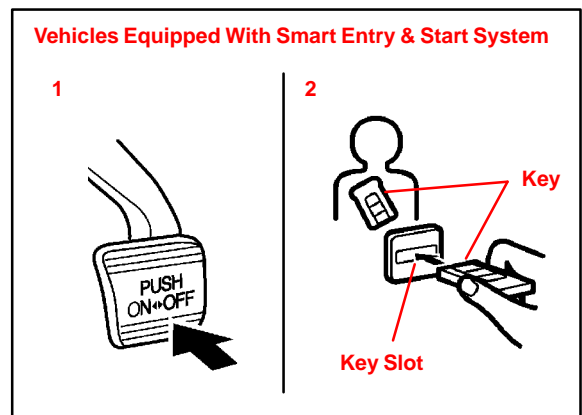
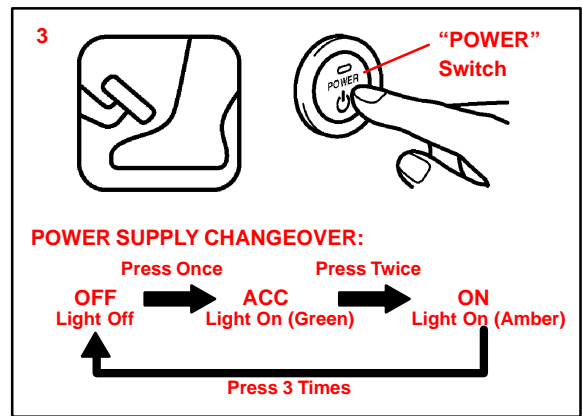
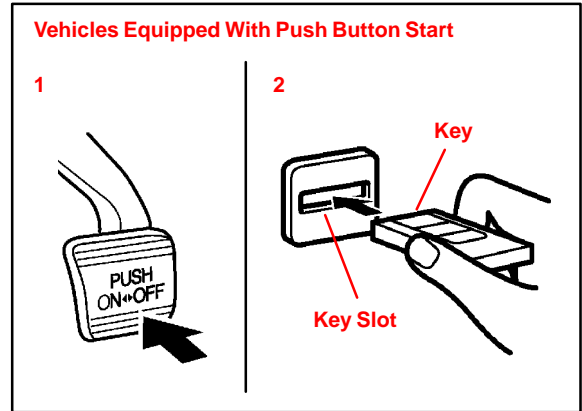

\* Inspect or install when equipped or required

**Functional  
Operation**  
(Continued)

4. In each mode, check that the power supply has changed properly and that the “POWER” switch indicator has illuminated.

**HINT:**

If the “POWER” switch indicator blinks in amber, refer to the Repair Manual.

**NOTE:**

If the vehicle is equipped with the Smart Entry & Start system, after performing the inspections above, remove the key from the key slot and perform the inspections again while carrying the key.

5. Turn the hybrid system to the “IG-ON” position.
6. While depressing the brake pedal, put the running mode selector lever in a position other than “P.”

**HINT:**

During this operation, the running mode selector lever can be put only into “N” position other than “P.”

7. Check that the power supply automatically returns to the “OFF” position when the “POWER” switch is pressed with the brake pedal depressed.

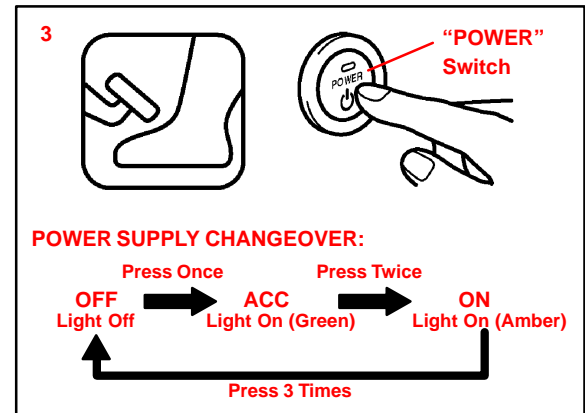

Functional  
Operation  
(Continued)

**B02. Check hybrid system start/stop**

**HINT:**

If the negative (–) battery terminal is reconnected, even if the “POWER” switch is pressed once, the hybrid system may NOT start. At this time, the “READY” light is OFF. In this case, press the “POWER” switch again to start the hybrid system (the “READY” light is ON). If it still does NOT start (the “READY” light is OFF), refer to the Repair Manual.

1. Apply the parking brake.
2. Make sure to fully insert the key into the key slot.
3. While depressing the brake pedal, press the “POWER” switch to start the hybrid system (the “READY” light is ON). Check that the “READY” light in the meter has illuminated.
4. When the hybrid system has started (the “READY” light is ON), check that the “P” position switch light has illuminated and that the frame around the letters of the “P” position indicator has illuminated.

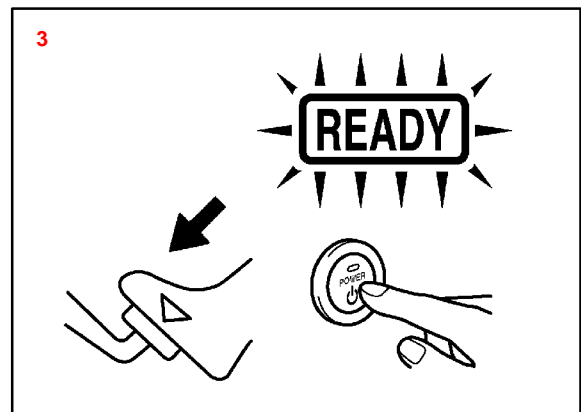
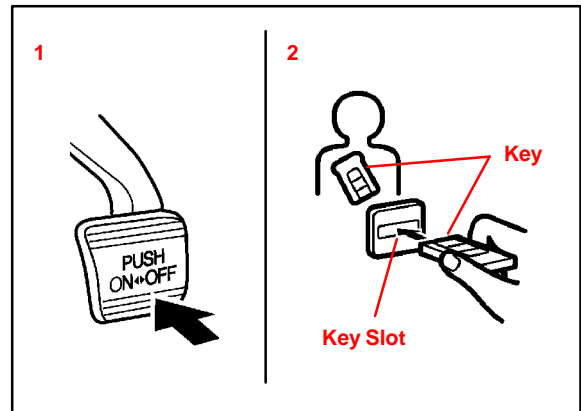

**HINT:**

- When the “READY” light illuminates, it means that the hybrid system has started (the “READY” light is ON), and the vehicle is ready to be driven.
- After the hybrid system has started (the “READY” light is ON), if the “P” position switch light blinks in amber and the frame around the indicator letters does NOT illuminate, refer to the Repair Manual.

**Functional  
Operation**  
(Continued)

5. To stop the hybrid system (the “READY” light is OFF), make sure the “P” position switch is illuminated before pressing the “POWER” switch again. This will cause the hybrid system to stop (the “READY” light is OFF). Check that all the indicators in the meter have extinguished.

**HINT:**

For vehicles equipped with the Smart Entry & Start system, after performing the inspections above, do NOT insert the key in the key slot, but carry it and perform inspections 1–5 again.

**B03. Check hybrid vehicle  
Immobilizer system**

**HINT:**

For vehicles equipped with the Smart Entry & Start system, after performing the inspections below, do NOT insert the key in the key slot, but carry it and perform the inspections again.

1. Check that the hybrid vehicle Immobilizer indicator light flashes when the key is removed from the key slot.
2. Insert the key half way into the key slot and check that the hybrid vehicle Immobilizer indicator light is blinking.
3. Check that the hybrid vehicle Immobilizer indicator light goes OFF with the key fully inserted into the key slot.
4. With the hybrid system OFF (the “READY” light is OFF) and the key fully inserted into the key slot, check that the buzzer sounds when the driver’s door is opened with.

Hybrid Vehicle Immobilizer Indicator Light

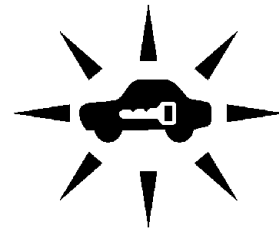

**Functional  
Operation**  
(Continued)

5. Check that the hybrid system can be started (the “READY” light is ON) using all the keys.

For vehicles equipped with the Smart Entry & Start system:

6. With the key placed outside the vehicle, check that the hybrid system will NOT start (the “READY” light is OFF). Also check that the Smart Entry system warning light will illuminate for 5 seconds.

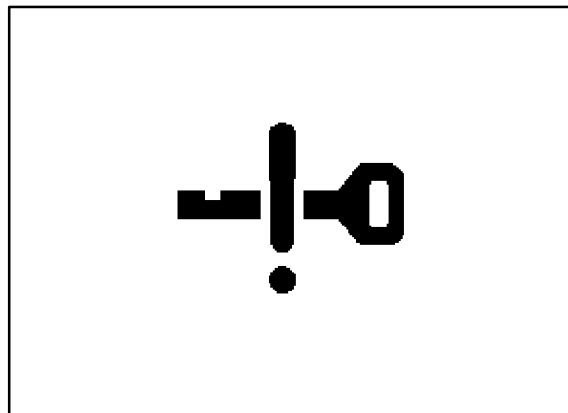
**B04. Check warning/indicator lights, buzzers, gauges, and multi-information display****HINT:**

For further details, refer to the Owner’s Manual.

1. Check warning and indicator lights in the meter.
  - a. SRS Warning Light  
After turning the hybrid system to the “IG-ON” position, check that the SRS warning light illuminates for 6 seconds before it turns OFF.
  - b. Low Temperature Indicator  
After turning the hybrid system to the “IG-ON” position, check that the low temperature indicator illuminates for 3 seconds before it turns OFF. After starting the hybrid system (the “READY” light is ON), check that the low temperature indicator turns OFF when the outside temperature is +3 °C (37.4 °F) or more. Check that the low temperature indicator illuminates, when the outside temperature is below +3 °C (37.4 °F).
  - c. Brake System Warning Light (Red)  
After starting the hybrid system (the “READY” light is ON) with the parking brake applied, check that the brake warning light (red) illuminates. Check that the brake warning light turns OFF when the parking brake is released.

**HINT:**

When the hybrid system is started (the “READY” light is ON) with the parking brake released, the brake warning light may remain illuminated for 60 seconds. This is normal if the light will turn OFF afterwards.



**Functional  
Operation**  
(Continued)

- d. ABS, VSC, Electronic Control Brake Warning Light (Yellow), Engine Warning Light, Slip Indicator Light

After turning the hybrid system to the “IG-ON” position, check that the warning lights and indicator light above will illuminate. After starting the hybrid system (the “READY” light is ON), check that the warning lights and indicator light above will turn OFF.

**HINT:**

**When the hybrid system is started (the “READY” light is ON), the ABS, VSC, and brake warning lights may remain illuminated for 60 seconds. This is normal if the lights will turn OFF afterwards.**

- e. Open Door Warning Light

Open one of the doors and check that the open door warning light illuminates.

Close the door and check that the open door warning light turns OFF.

- f. Driver’s and Passenger’s Seat Belt Reminder Lights

After turning the hybrid system to the “IG-ON” position, check that the driver’s seat belt reminder light blinks and that it turns OFF when the seat belt is fastened. While sitting in the passenger seat, turn the hybrid system to the “IG-ON” position and check that the passenger seat belt reminder light blinks and that it turns OFF when the seat belt is fastened.

**HINT:**

**Perform the check on the passenger’s side when inspecting the passenger’s seat.**









- g. Low Fuel Level Warning Light

Low fuel level warning light blinks when the fuel tank becomes nearly empty.





- h. Master Warning Light

Comes ON only when there is some malfunction in the system.

**Functional Operation**  
(Continued)

WARNING LIGHTS & BUZZERS		FUNCTION
a		SRS Warning Light This light will remain ON as an SRS malfunction warning.
b		Low Temperature Indicator This light illuminates when the outside temperature is +3 °C (37.4 °F) or below.
c	<b>BRAKE</b> or 	Brake System Warning Light (Red) and Buzzer This light warns that there is a malfunction somewhere in the brake system. If the brake system fails seriously, the warning buzzer also may sound.
d	<b>ABS</b> or 	ABS Warning Light This light illuminates when there is a malfunction in the ABS & brake assist system or the VSC system.
		VSC Warning Light <ul style="list-style-type: none"> <li>This light illuminates when there is a malfunction in the VSC system and the Motive Force Suppression Control (Motor Traction Control).</li> <li>This light illuminates when there is a malfunction in the HV system.</li> </ul>
		Electronic Control Brake Warning Light (Yellow) <ul style="list-style-type: none"> <li>This light illuminates when there is a malfunction in the electronic control brake system.</li> <li>The brake system warning light (red) also illuminates when a malfunction affecting braking performance occurs.</li> </ul>
		Slip Indicator Light This light blinks when the ABS system, the VSC system, or the Motive Force Suppression Control (Motor Traction Control) is operated.
		Malfunction Indicator Lamp With the hybrid system started (the "READY" light is ON), this light illuminates when there is a malfunction in the engine electronic control system or the electronic control throttle system.

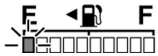
**Functional Operation**  
(Continued)







WARNING LIGHTS & BUZZERS		FUNCTION	
e		Open Door Warning Light	This light remains illuminated until all the doors are completely closed.
f		Driver's Seat Belt Reminder Lights and Buzzer, Front Passenger's Seat Belt Reminder Lights	This light blinks if the driver's and passenger's seat belts is/are NOT fastened.
g		Low Fuel Level Indicator Light	This light blinks when the fuel tank becomes nearly empty.
h		Master Warning Light	<p>This light illuminates if there is a malfunction in any of the following systems:</p> <ul style="list-style-type: none"> <li>• Hybrid system</li> <li>• Shift-by-wire system</li> <li>• Engine oil pressure system</li> <li>• Engine coolant temperature system</li> <li>• Auxiliary battery charging system</li> <li>• Electric power steering system</li> <li>• Hybrid main battery system</li> </ul> <p>When the master warning light illuminates, the buzzer sounds and the icon of the system where the malfunction occurred appears on the multi-information display.</p>

**Functional  
Operation**  
(Continued)

2. Check the warning lights in the multi-information display.  
When the hybrid system is turned to the “ACC” or “IG-ON” position or when the hybrid system is started (the “READY” light is ON), check that the following warning lights do NOT appear on the multi-information display.

**NOTE:**

- The following warning lights appear on the multi-information display only when there is a malfunction in the respective system.
- If the following warning lights appear, refer to the Repair Manual.

WARNING LIGHTS (In Multi-Information Display)		FUNCTION
	Discharge Warning Light	This light illuminates if there is a malfunction in the charging system (DC/DC converter, auxiliary battery, etc.).
	Low Engine Oil Pressure Warning Light	This light illuminates if the engine oil pressure is abnormal.
	Coolant Temperature Indicator Light	This light illuminates if the hybrid system is almost over-heating.
P/S	Electric Power Steering System Warning Light	This light illuminates when the electric power steering control system fails.
	Hybrid System Warning Light	This light illuminates if there is a malfunction in the electric motor, inverter unit, hybrid vehicle battery, etc.
	Hybrid Vehicle Battery Warning Light	<ul style="list-style-type: none"> <li>• This light illuminates when the hybrid vehicle battery voltage drops with the running mode selector lever left in the “N” position.</li> <li>• The system works properly if you put the running mode selector lever in the “P” position and the light turns OFF.</li> <li>• This light illuminates if the fuel tank is completely empty.</li> <li>• This light illuminates if the hybrid vehicle battery is discharged.</li> </ul>
	Automatic Headlight Leveling System Warning Light	This light illuminates if there is a malfunction in the automatic headlight leveling system.

**Functional  
Operation**  
(Continued)

3. Check buzzers.
  - a. Check the key reminder buzzer.  
With the key inserted into the key slot and the hybrid system turned to the “OFF” or “ACC” position, open the driver’s door and check that the key reminder buzzer sounds.
  - b. Check the light reminder buzzer.  
With the headlight switch in the “ON” position and the key removed from the key slot, open the driver’s door and check that the light reminder buzzer sounds.
  - c. Check the shift position reminder buzzer.  
While the hybrid system is operating (the “READY” light is ON), with the shift lever in a position other than “P” or “R,” open the driver’s door and check that the shift position reminder buzzer sounds and the master warning light illuminates. At the same time, check the warning messages on the multi-information display.
  - d. Check the reverse warning buzzer.  
While the hybrid system is operating (the “READY” light is ON), move the shift lever to the “R” position and check that the reverse warning buzzer sounds.

**B05. Check windshield wipers and washers**

**B06. Check headlights, instrument lights, dimmer switch, turn signals, emergency flashers, and brake lights**

**B07. Check inside/outside rear view mirror operation/adjustment**

**B08. Check power outlet**

**NOTE:**

The power outlet only works with the ignition in “ACC” or “ON.” Check the outlet using an electrical accessory designed for this use.

**B09. Check audio system operation and set clock**

**HINT:**

For details, refer to the Owner’s Manual.

1. Push the power volume switch ON and check that it operates smoothly.
2. Preset the station selector buttons to the local broadcast frequencies.

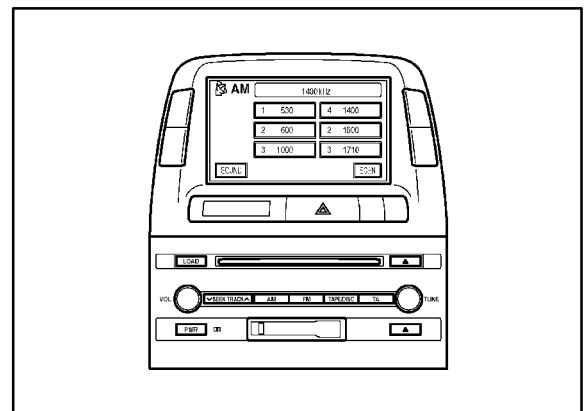

**Functional Operation**  
(Continued)

3. Check the cassette and compact disc player operation.
4. Operate the steering pad switches and check that the audio system can be controlled.

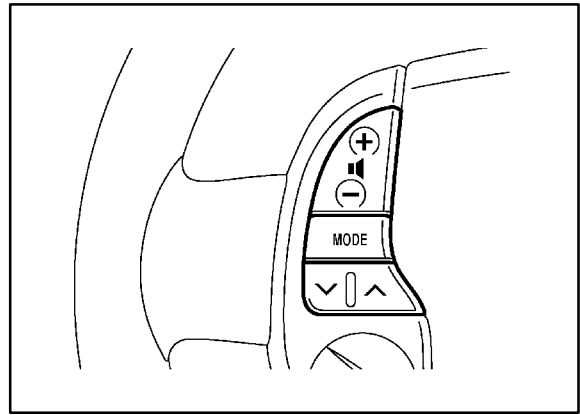

**B10. Check dome, personal, courtesy, and sun visor lights**

**B11. Erase Diagnostic Trouble Codes (DTCs) B1200, B1207, and B1271**

**Walkaround Inspection**

Start at left front door. Check window and door lock operation (from master power switch, if equipped). Continue around vehicle in a counterclockwise direction checking each door and window operation, child door locks, seat belts, interior condition, all lights, trunk contents. Remove rubber body plugs from glove box for installation during UNDER VEHICLE inspection.

**C01. Check power window operation**

1. Check that the door windows open and close smoothly using the power window switches on each door.

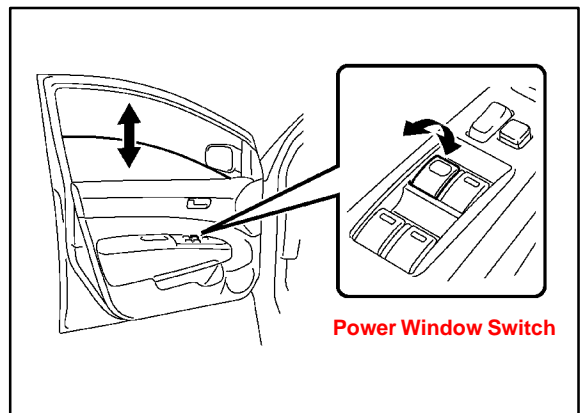

Automatic operation:

2. Check for proper operation of the “one-touch open and close” function by fully pushing the switch down once and fully pulling the switch up once.
3. Check that the windows (other than the driver’s window) cannot be operated after the window lock switch is open.

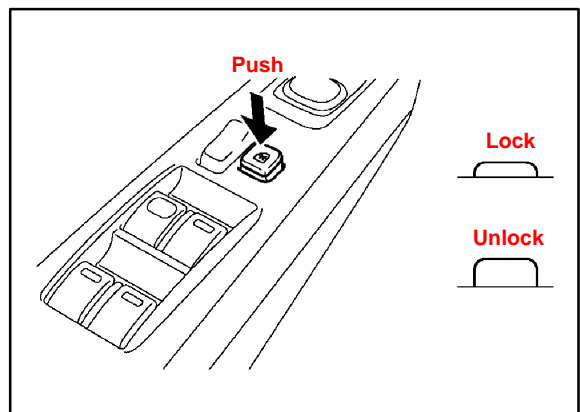

**Walkaround  
Inspection**  
(Continued)

All windows should operate without any abnormal noise.

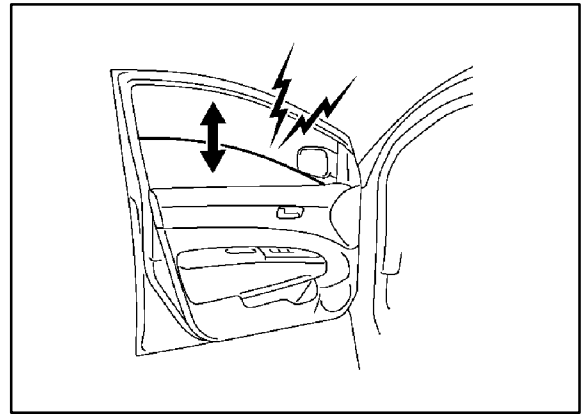

**C02. Check door and door lock operation**

**C03. Check operation of wireless door lock remote control system**

1. Press the LOCK switch on the key and check that all the doors lock. Check that the hazard lights and the LED on the key blink once when the switch is pressed.
2. Press the UNLOCK switch on the key\* and check that all the doors unlock. Check that the hazard lights and the LED on the key blinks twice when the switch is pressed.

\* North American specification only:

Press the switch once to unlock the driver's door. Press it twice to unlock all the doors.

3. After checking the UNLOCK function, wait for approximately 30 seconds without opening the doors and check that the doors lock automatically.
4. Push the LOCK switch on the key while one of the doors is open and check that the buzzer sounds.

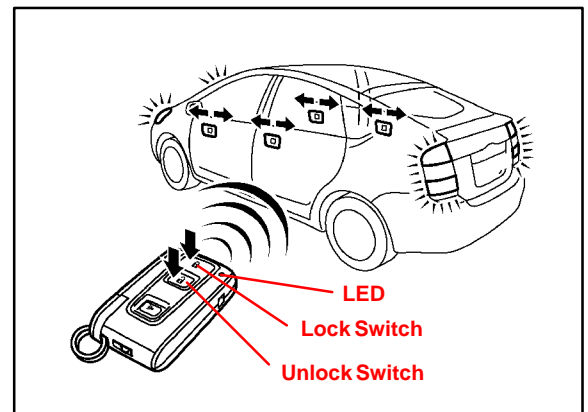

**Walkaround  
Inspection**  
(Continued)

**C04. Check operation of Smart Entry  
& Start system\***

**HINT:**

Perform the following inspections only on a vehicle equipped with the Smart Entry system.

1. With the Smart Key placed within the vehicle, push the lock button on the outside handle and check that the buzzer sounds and that the door does NOT lock.
2. Take the Smart Key and get out of the vehicle. Push the lock button on the outside handle and check that the door locks.
3. From a distance of at least 1 meter (39 inches), approach the vehicle and pull the outside handle of left and right sides and the back door opener. Check that the door unlocks.

**HINT:**

The doors cannot be unlocked for 3 seconds after the doors are locked.

4. Check that the back door is unlocked by pushing the back door opener.
5. Push the Smart cancel switch and check that the Smart Entry function does NOT operate.

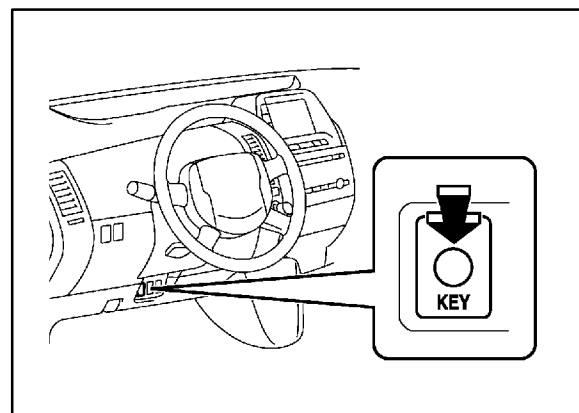
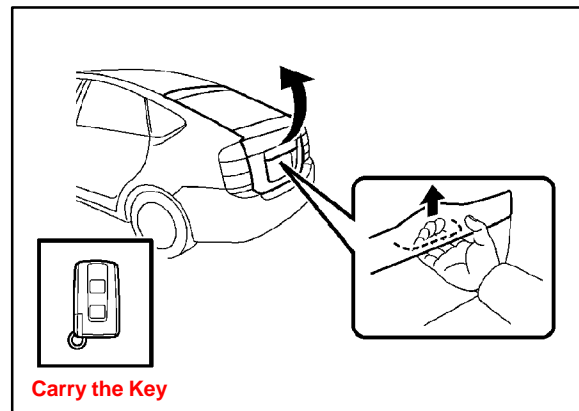
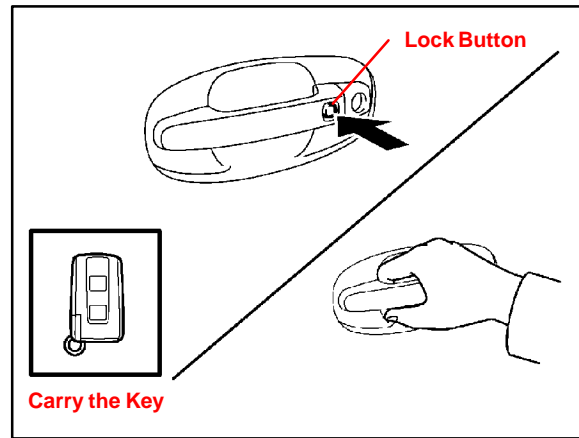

*\* Inspect or install when equipped or required*



**Walkaround  
Inspection**  
(Continued)

**C05. Check operation of theft  
deterrent system\***

1. With all the doors and the hood closed, use the wireless key to lock all of the doors.
2. Check that the theft deterrent system indicator light in the meter illuminates for 30 seconds after the doors are locked and blinks afterwards.
3. Turn the door lock button in the vehicle to the unlock position and check that the headlights blink and the horn sounds.
4. Cancel the security system by unlocking it with the wireless key.
5. Check that the horn sounds when the panic button is pushed.

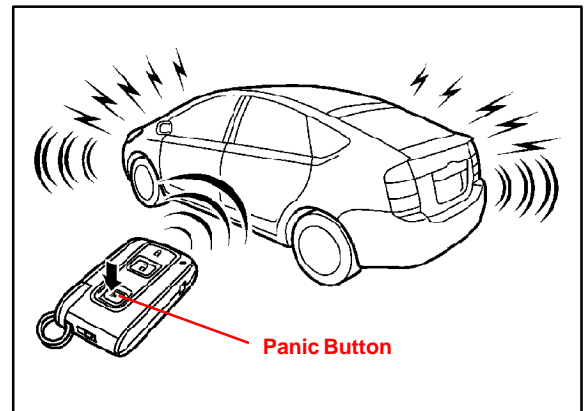
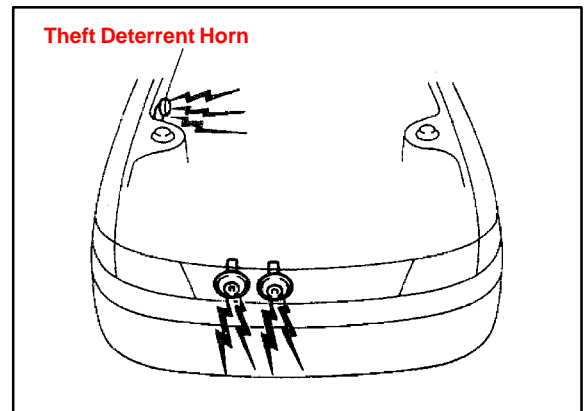
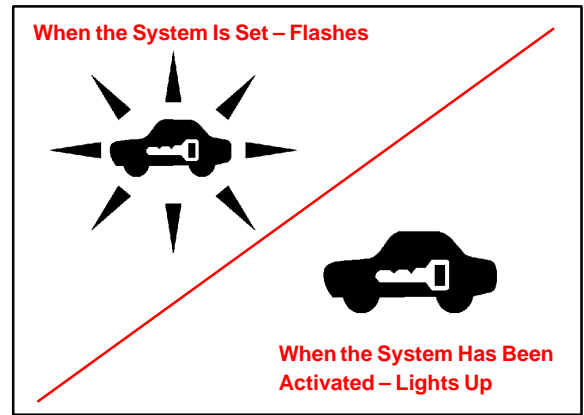

*\* Inspect or install when equipped or required*

**Walkaround  
Inspection**  
(Continued)

**C06. Check child safety door locks are in normal (unlocked) position**

With the child-protector in the lock position, check that the rear door cannot be opened by the inside handle and can be opened by the outside handle.

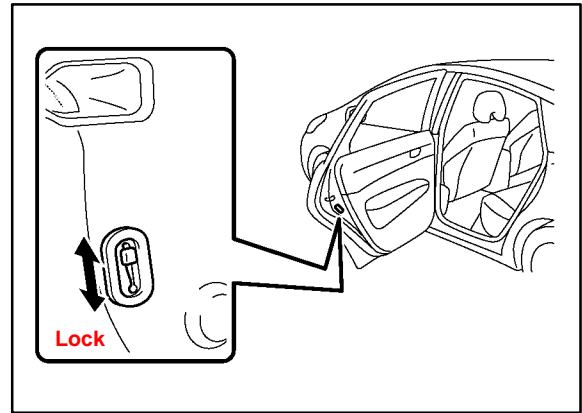

**C07. Check seats and seat belt operation**

**C08. Check rear defogger**

**C09. Check side marker, tail, backup, and license plate lights**

**C10. Check trunk light and trunk trim appearance**

**C11. Check spare tire pressure and jack and tool installation**

**NOTE:**

Check and adjust spare tire inflation pressure (compact spare — 60 psi [420 kPa]).

**C12. Check 12-volt auxiliary battery terminal tightness.**

1. Turn OFF all lights and accessories.
2. Stop the hybrid system (the “READY” light is OFF).
3. Remove the auxiliary battery cover.

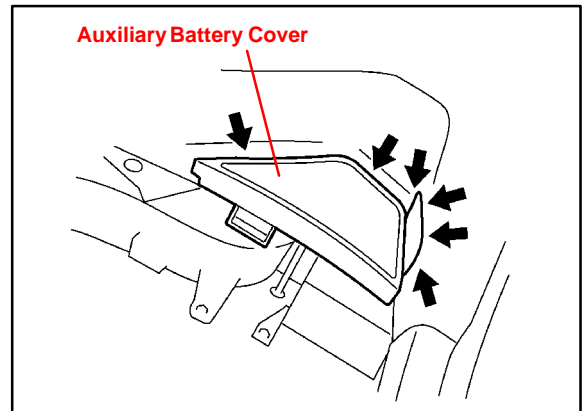

4. Remove the positive (+) terminal cover.
5. Check that the terminals are tightly connected and the clamps properly installed.

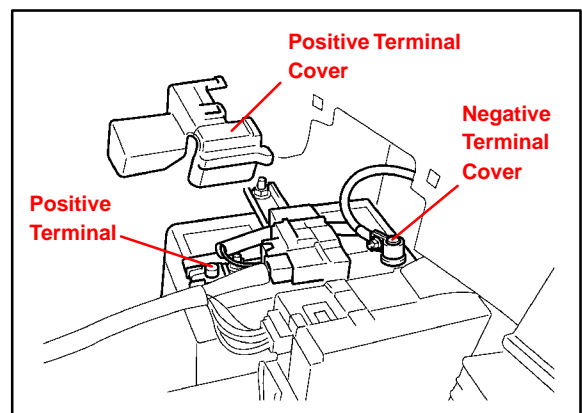

**C13. Check 12-volt auxiliary battery state-of-charge**

**Under Hood D01. Check engine oil level****D02. Check brake fluid level**

Visually check the fluid level of the reservoir tank.

1. Stop the hybrid system (the “READY” light is OFF).
2. Depress the brake pedal more than 40 times.
3. Check that the fluid level is at the “MAX” line. If low, add FMVSS No. 116 DOT 3 or SAE J1703 brake fluid up to the “MAX” line.

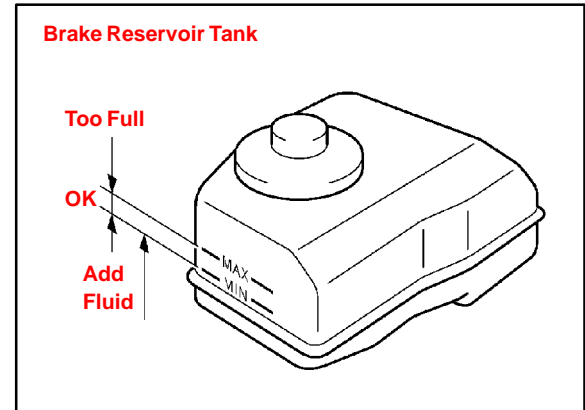
**D03. Check engine coolant level****HINT:**

- Check the coolant level when the hybrid system is cold.
- The coolant level in the reservoir will vary with the hybrid system temperature.

Visually check the coolant level of the reservoir tank. If low, add only “TOYOTA Super Long Life Coolant” or similar high quality ethylene glycol based non-silicate, non-amine, non-nitrite, and non-borate coolant with long-life hybrid organic acid technology to the “FULL” line.

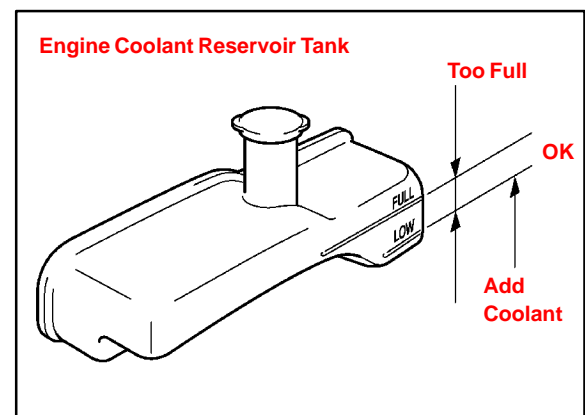
**D04. Check inverter coolant level**

Check the coolant level of the reservoir tank.

1. Stop the hybrid system (the “READY” light is OFF).
2. Check that the inverter coolant level is between the “FULL” and “LOW.” If low, add only “TOYOTA Super Long Life Coolant” or similar high quality ethylene glycol based non-silicate, non-amine, non-nitrite, and non-borate coolant with long-life hybrid organic acid technology to the “FULL” line.

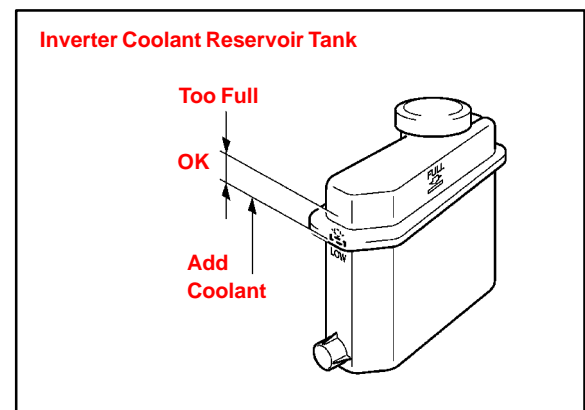

**Under Hood**  
(Continued)

- D05. Check windshield washer fluid level**
- D06. Inspect for fuel, oil, coolant, and other fluid leaks**

**Under Vehicle**  
(On Hoist)

- E01. Remove disc brake anti-corrosion wheel film**  
Visually inspect rotors for rust.

**NOTE:**

For best rotor rust prevention, retain wheel film on vehicle until just prior to customer delivery.

- E02. Install rubber body plugs**

**NOTE:**

Two body plugs are stored in the glove box.

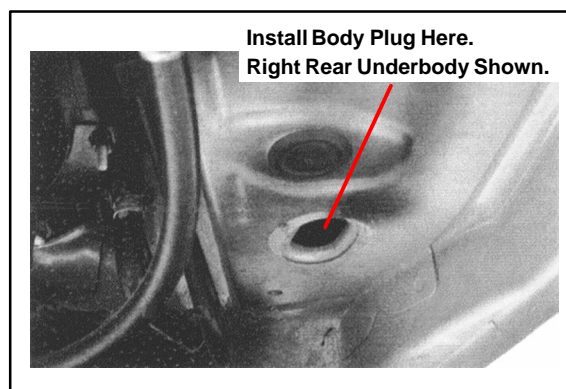

- E03. Inspect for fuel, oil, coolant, and other fluid leaks**  
Wipe up any spilled fluids and repair as necessary.
- E04. Visually check bolts and nuts on chassis and powertrain for looseness**
- E05. Inspect under the vehicle for damage, rust, etc.**
- E06. Activate tire pressure monitor**
- E07. Install wheel caps/covers**
- E08. Install front spoiler**
- E09. Install rear lower side spoiler set**

**Road Test** A complete road test helps assure customer satisfaction. Drive the vehicle over a variety of road surfaces and driving conditions. Check for unusual noises and vehicle performance.

**F01. Check vehicle operation at cold, at warm-up, and at normal operating temperatures**

**F02. Check hybrid transaxle operation**

**HINT:**

For details on operational methods, refer to the Owner's Manual.

1. Check that the shift lever can be moved smoothly to each position and that it returns to the home position when it is let go.
2. When the shift lever is in each position, check that the appropriate indicator box illuminates on the instrument cluster. When the "P" position switch is pressed to select Park, check that the "P" position switch light illuminates and "P" is indicated on the instrument cluster.
3. Check the transaxle operation at each shift position.
  - P:** Parking, hybrid system starting (the "READY" light is ON) and key removal position
  - R:** Reverse position
  - N:** Neutral position
  - D:** Normal driving position
  - B:** Engine braking position

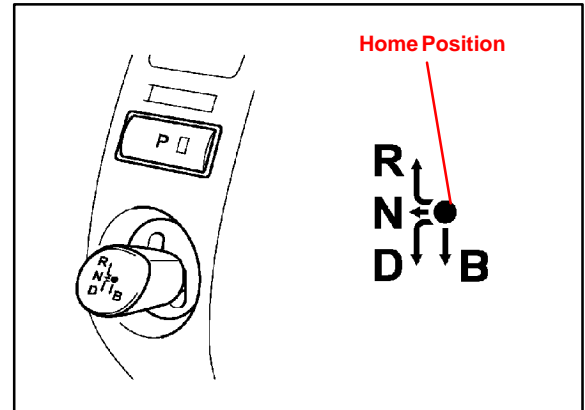

**F03. Check brake and parking brake operation**

**F04. Check steering operation and for steering wheel off-center**

Road Test  
(Continued)

**F05. Check speedometer operation**

Push the “km/h / MPH” button and check that the display changes between km/h and mph.

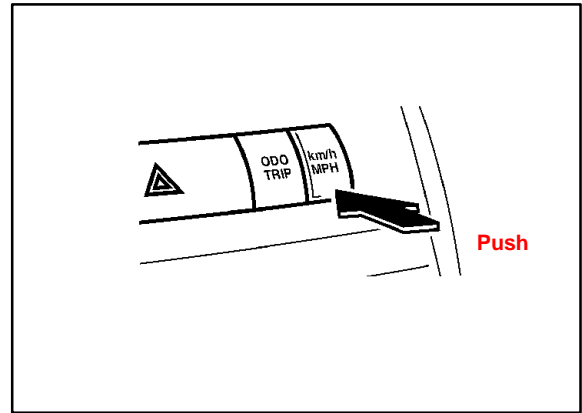

**F06. Inspect for abnormal noise and vibration**

**F07. Inspect for squeaks and rattles**

**F08. Check heater and A/C operation**

1. Check the control operation and indicator display of the switches below.

Control operation:

- a. Fan speed control
- b. OFF switch
- c. Air flow mode control
- d. A/C switch

Control operation and indicator display:

- e. Air inlet control
- f. Front defroster
- g. Rear defogger
- h. Temperature and automatic control

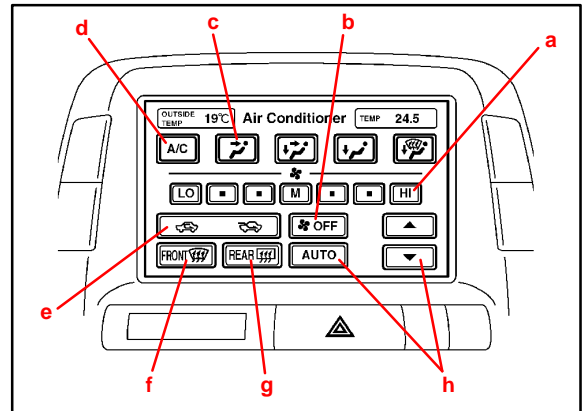

**Road Test**  
(Continued)

2. Check that the air flow changes in accordance with the air flow mode control level or switch.

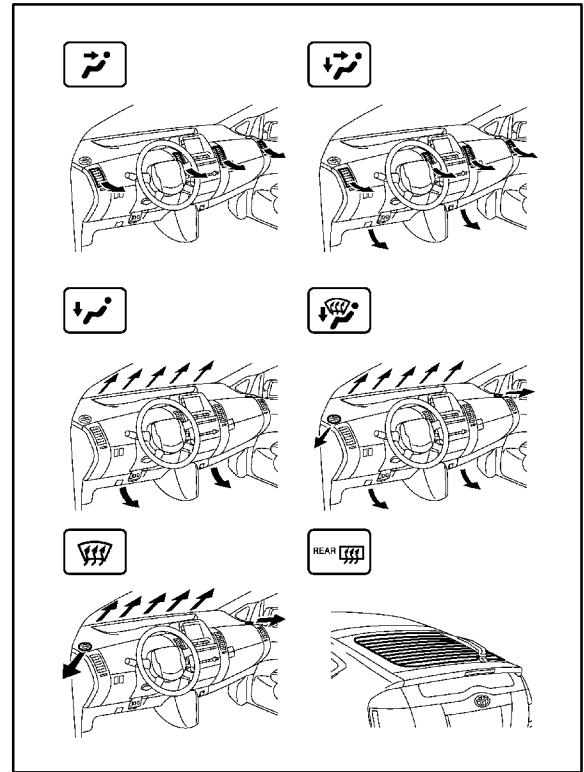

3. Operate the steering pad switches and check that the following controls operate properly and that the respective indicator illuminates:

- Temperature control
- Automatic control
- Front defroster
- Rear defogger
- Air inlet control

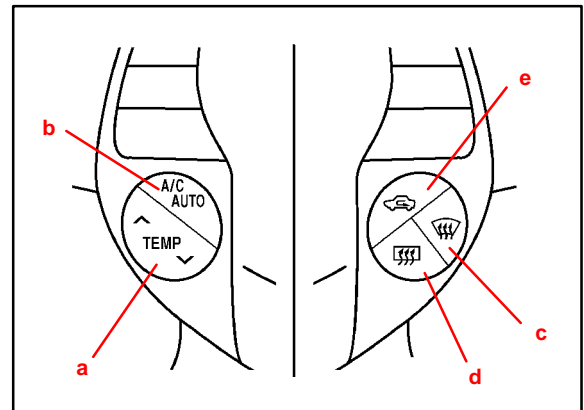

**F09. Check cruise control operation\***

Check cruise control including “ON-OFF” switch, “SET/COAST,” “RESUME/ACCEL,” and “CANCEL” functions.

*\* Inspect or install when equipped or required*

Road Test  
(Continued)

## F10. Initialize Navigation system\*

**HINT:**

For details, refer to the Owner's Manual.

1. Set the hybrid system to the "ACC" or "IG-ON" position and check that the initial "TOYOTA" screen appears for a few seconds and then changes to the "MAP," "ENERGY MONITOR," "FUEL CONSUMPTION" screen, or "SCREEN OFF" (dark screen) depending on the previous display.
2. Push the "MAP," "DEST," "MENU," "INFO," "DISPLAY," "CLIMATE," or "AUDIO" button and check that the display changes according to the pressed button.

**HINT:**

On vehicles without the Navigation System, the "MAP," "DEST," and "MENU" buttons do NOT work even if pushed.

3. Operate the steering pad switches and check that the "MAP," "INFO," "TELEPHONE," and "SPEECH COMMAND SYSTEM" can be controlled.

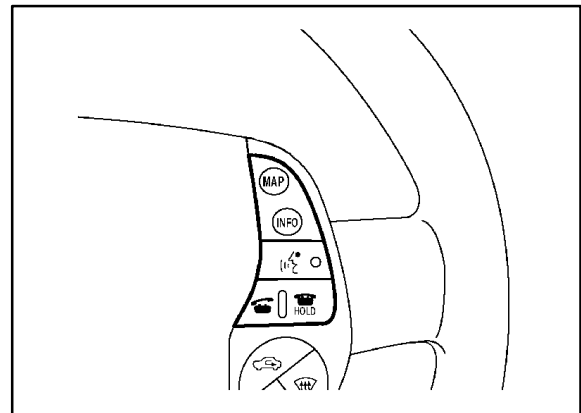
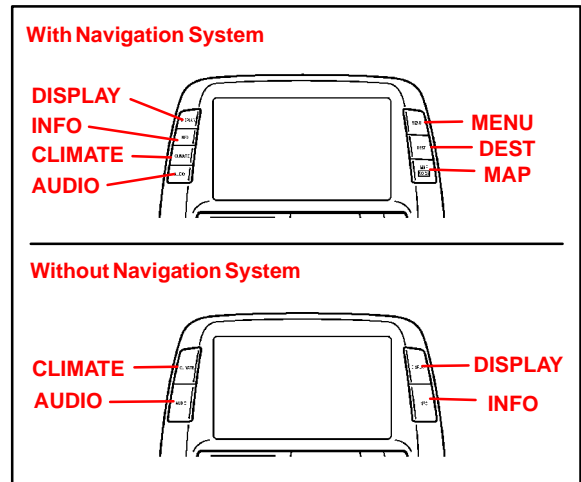

\* Inspect or install when equipped or required



**Final  
Inspection  
& Cleaning****G01. Remove interior protective covers, unnecessary labels, tags, etc.**

(Remove protective covers just before delivery to customer.)

- Remove plastic covers from:
  - Door panels
  - Seats
  - Head restraints
  - Sun visors
  - Front pillar
  - Instrument panel
  - Center console
  - Shift lever
  - Cruise control switch
  - Inner scuff plate
  - Driver's side floor (protective paper)
- Remove labels, tags, and stickers (except those containing owner information).

**NOTE:**

Customer information labels, such as the fuel caution, air bag warnings, and bumper labels, must be left on the vehicle until delivery to a retail customer.

**G02. Visually inspect all interior parts for installation, damage, fit, dirt, etc.**

**G03. Remove Rapgard™ protective film**

**G04. Wash and clean vehicle**

**G05. Inspect paint finish for scratches, chips, rust, dents, damage, etc.**

**G06. Inspect exterior body parts for proper installation, damage, rust, etc.**

**G07. Install front license plate mounting bracket and front license plate**

**Battery  
Maintenance**

**H01. Perform HV battery check and maintenance**