

MODEL 3

EMERGENCY RESPONSE GUIDE

This guide is intended only for use by trained and certified rescuers and first responders. It assumes that readers have a comprehensive understanding of how safety systems work and have completed the appropriate training and certification required to safely handle rescue situations. Therefore, this guide provides only the specific information required to understand and safely handle the fully electric Model 3 in an emergency situation. It describes how to identify Model 3 and provides the locations and descriptions of its high voltage components, airbags, inflation cylinders, seat belt pre-tensioners, and the high strength materials used in its body structure. This guide includes the high voltage disabling procedure and any safety considerations specific to Model 3. Failure to follow recommended practices or procedures can result in serious injury or death.

The high voltage battery is the main energy source. Model 3 does not have a traditional gasoline or diesel engine and therefore does not have a fuel tank. The images in this guide might not match the vehicle you are working on.



- Safety Information..... 2**
- Important Safety Instructions.....2
- Warnings.....2
- Identifying the Vehicle 3**
- Badging and Door Handles.....3
- Vehicle Identification Number (VIN).....4
- Touchscreen.....5
- Electric Vehicle Components..... 6**
- High Voltage Components.....6
- High Voltage Battery.....7
- High Voltage Cables.....8
- Drive Unit.....9
- 12 Volt Battery.....10
- Stabilizing the Vehicle..... 11**
- Chock All Four Wheels.....11
- Shift Into Park..... 11
- Disabling the High Voltage System..... 12**
- Front Trunk First Responder Cut Loop.....12
- Cutting the Front Trunk First Responder Loop.....13
- Rear Pillar First Responder Cut Loop.....15
- Cutting the Rear Pillar First Responder Loop.....16
- Airbags and Components..... 17**
- Airbags.....17
- Airbag Inflation Cylinders.....18
- Seat Belt Pre-Tensioners..... 19
- Reinforcements..... 20**
- Reinforcements and Ultra High Strength Steel.....20
- No-Cut Zones..... 21
- Rescue Operations..... 22**
- Fully or Partially Submerged Vehicles.....22
- Pushing on the Floor Pan.....22
- Firefighting.....23
- High Voltage Battery - Fire Damage.....23
- Lifting the Vehicle..... 24**
- Lift Areas.....24
- Opening the Vehicle..... 25**
- Opening Doors from the Outside.....25
- Opening Doors From the Inside With Power.....26

- Opening Front Doors Without Power.....27
- Opening the Hood.....28
- Opening the Trunk.....31
- Pushing the Vehicle..... 32**
- Pushing the Vehicle.....32
- High Voltage Labels.....33**
- Example of a High Voltage Label.....33



IMPORTANT SAFETY INSTRUCTIONS

This document contains important instructions and warnings that must be followed when handling Model 3 in an emergency situation.

WARNINGS

- ▲ **Warning:** Always use appropriate tools, such as a hydraulic cutter, and always wear appropriate personal protective equipment (PPE) when cutting Model 3. Failure to follow these instructions can result in serious injury or death.
- ▲ **Warning:** Regardless of the disabling procedure you use, ALWAYS ASSUME THAT ALL HIGH VOLTAGE COMPONENTS ARE ENERGIZED! Cutting, crushing, or touching high voltage components can result in serious injury or death.
- ▲ **Warning:** After deactivation, the high voltage circuit requires 2 minutes to de-energize.
- ▲ **Warning:** The supplemental restraint system (SRS) control unit has a backup power supply with a discharge time of approximately ten seconds. Do not touch the SRS control unit within 10 seconds of an airbag or pre-tensioner deployment.
- ▲ **Warning:** Handling a submerged vehicle without appropriate PPE can result in serious injury or death.
- ▲ **Warning:** When fire is involved, consider the entire vehicle energized. Always wear full PPE, including a self-contained breathing apparatus (SCBA).
- ▲ **Warning:** When cutting the first responder loop, double cut the loop to remove an entire section. This eliminates the risk of the cut wires accidentally reconnecting.



BADGING AND DOOR HANDLES

Model 3 can be identified by its Tesla badges and uniquely-shaped door handles.

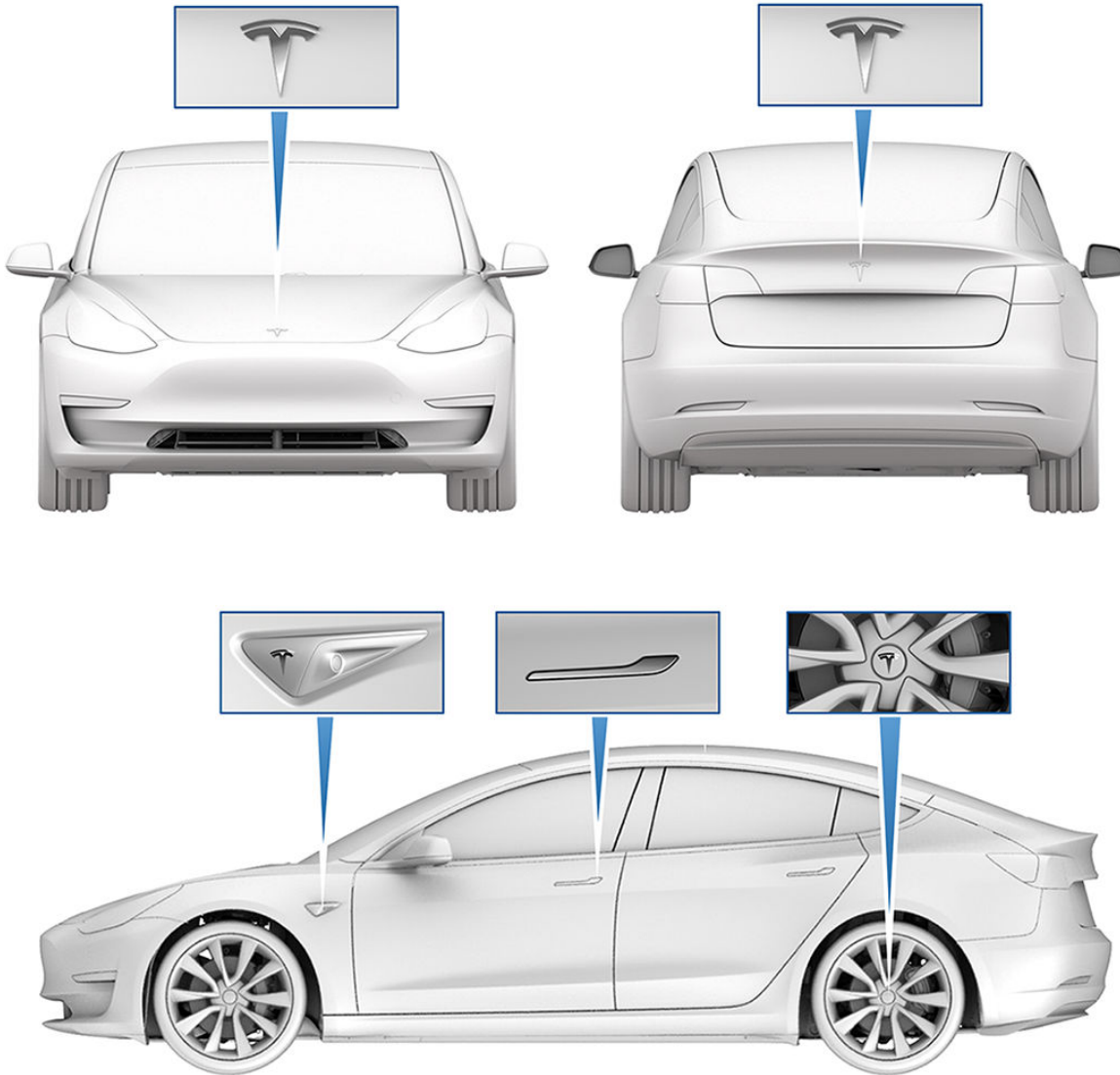



VEHICLE IDENTIFICATION NUMBER (VIN)

Model 3 can be identified by its VIN. Locate the stamped plate on the top of the dashboard by looking through the driver's side of the windshield. Model 3 is identified with a "3" in the 4th alphanumeric position.





TOUCHSCREEN

Model 3 can be identified by its 15 in (38 cm) touchscreen that is mounted in a "landscape" orientation.

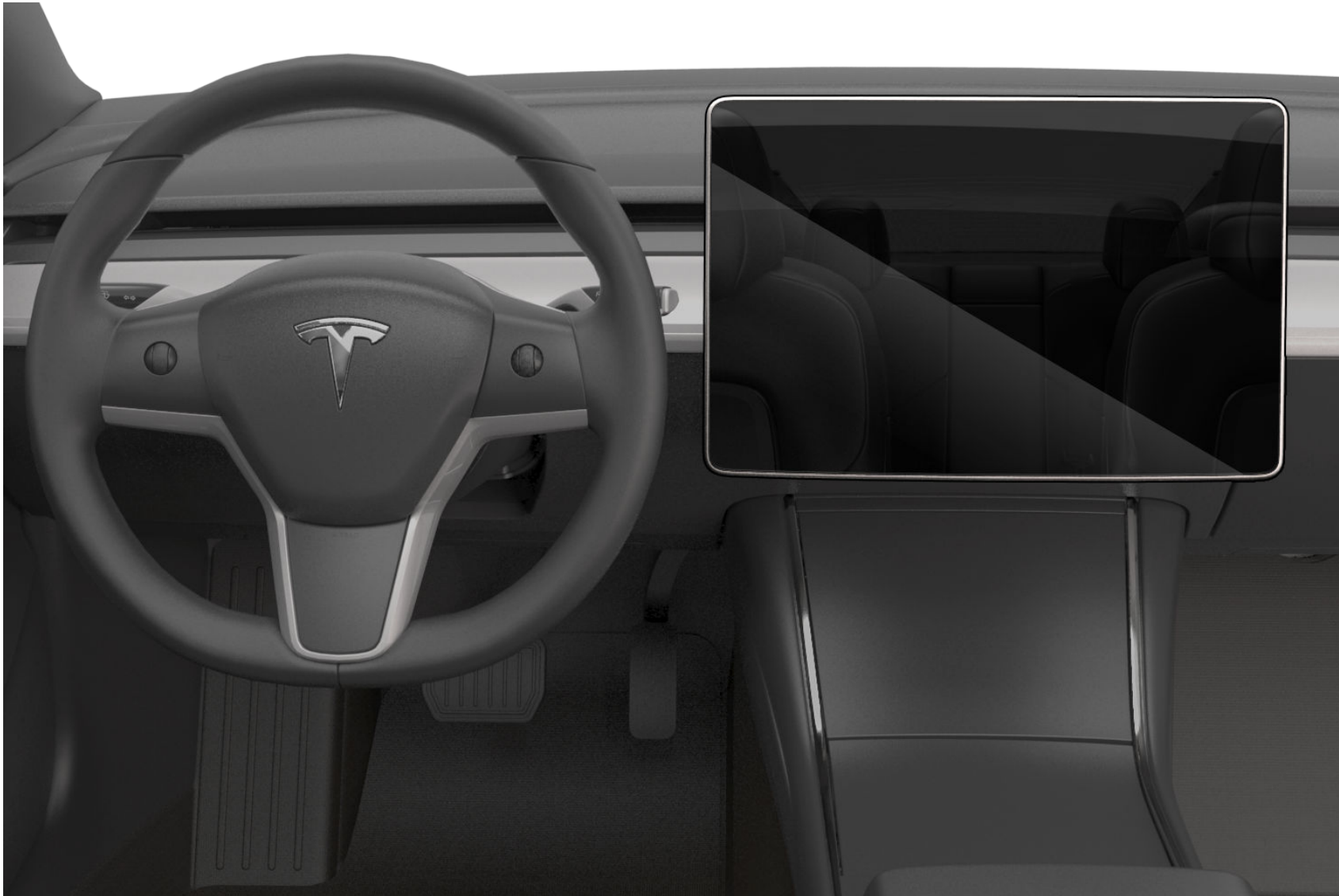



HIGH VOLTAGE COMPONENTS

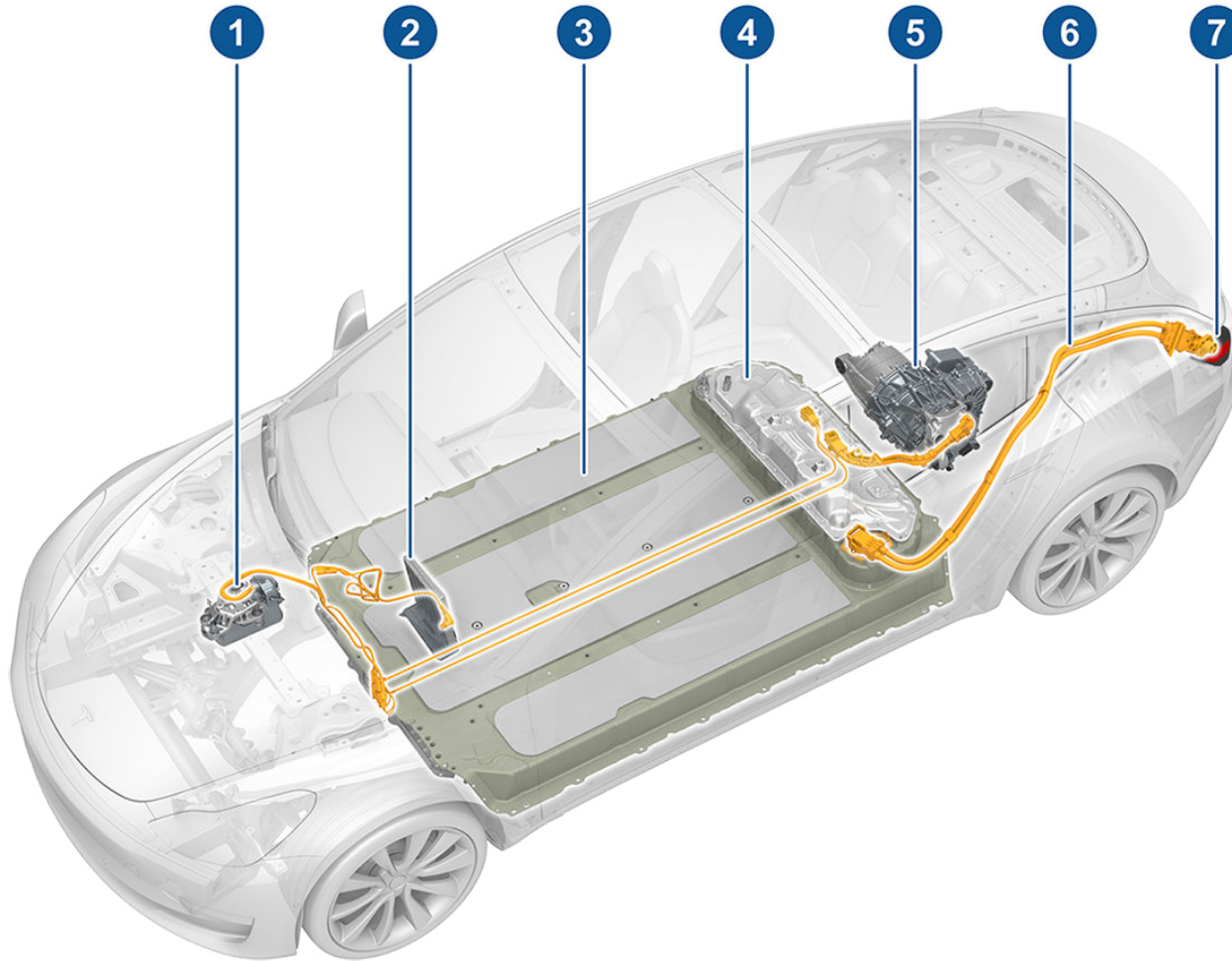

1. A/C Compressor
2. Cabin Heater
3. High Voltage Battery
4. High Voltage Battery Service Panel
5. Rear Drive Unit
6. High Voltage Cabling
7. Charge Port



HIGH VOLTAGE BATTERY

Model 3 is equipped with a floor-mounted 400 volt lithium-ion high voltage battery. Never breach the high voltage battery when lifting from under the vehicle. When using rescue tools, pay special attention to ensure that you do not breach the floor pan. Refer to [Lifting the Vehicle](#) on page 24 for instructions on how to properly lift the vehicle.

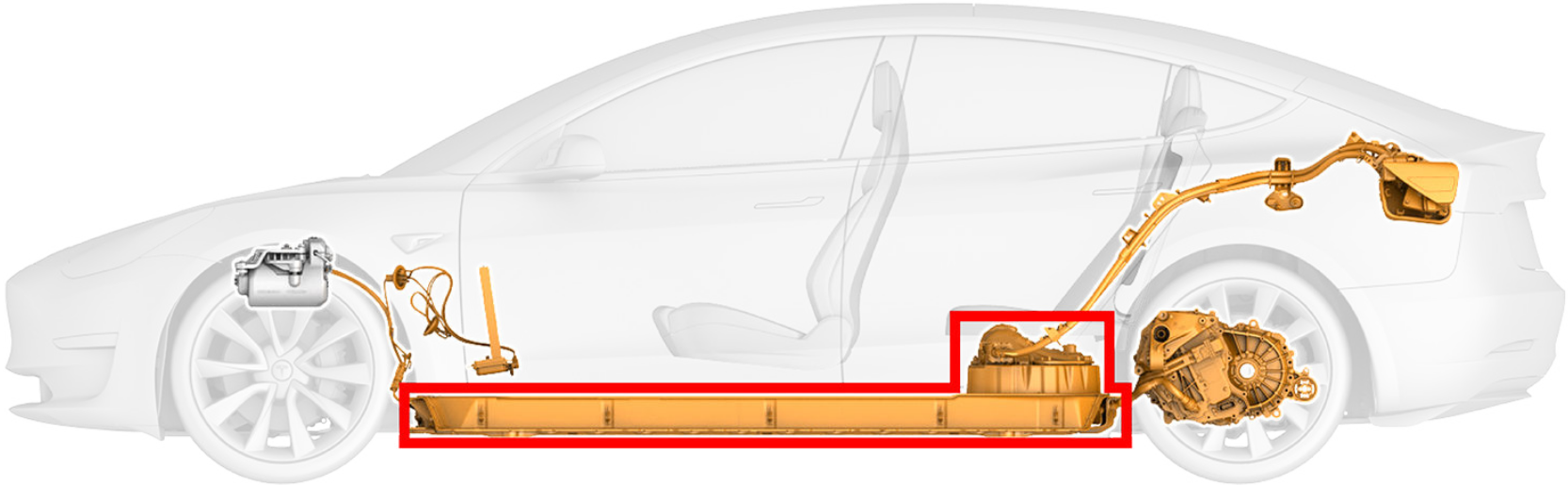



HIGH VOLTAGE CABLES

High voltage cables are shown in orange.

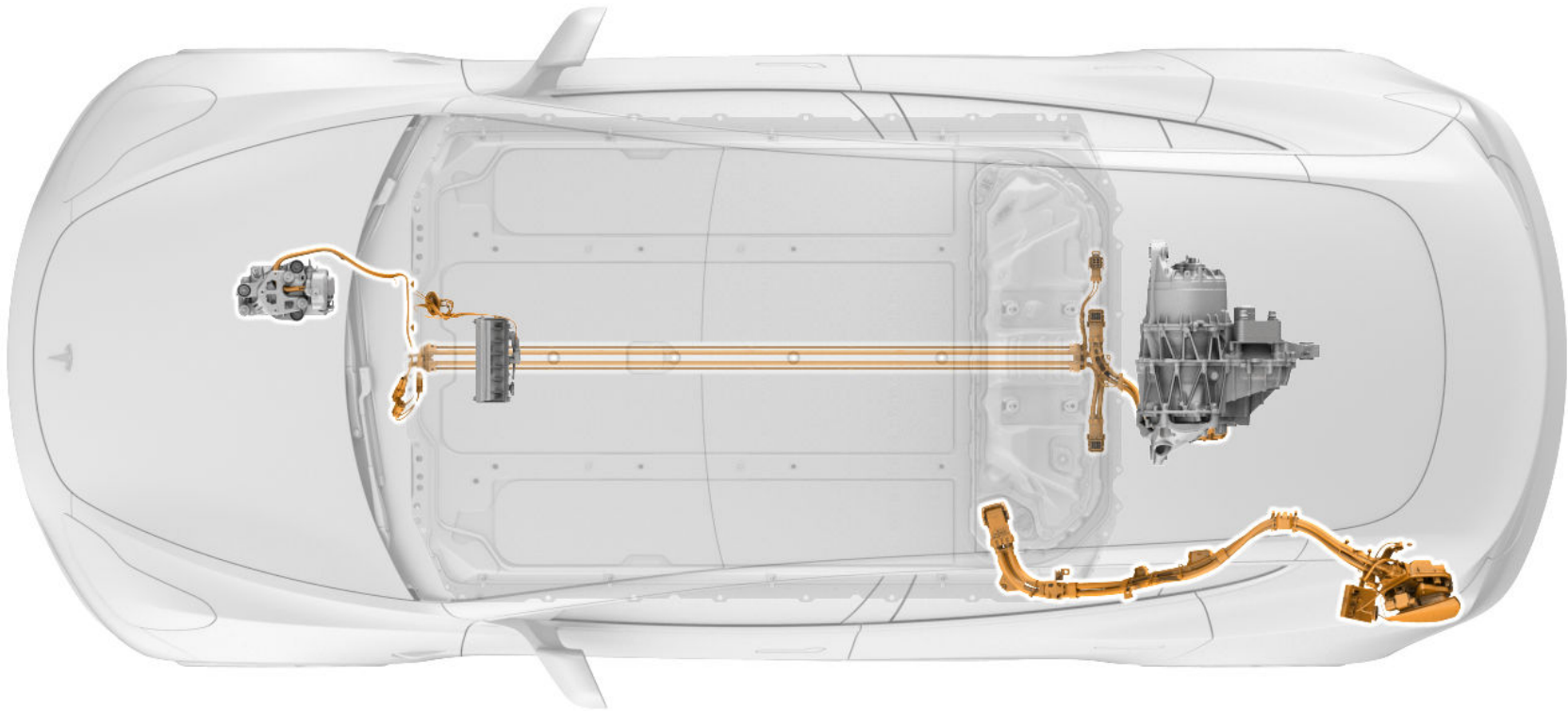



DRIVE UNIT

The rear drive unit is located between the rear wheels. The drive unit converts the direct current (DC) from the high voltage battery into 3-phase alternating current (AC) that the drive unit uses to power the wheels.

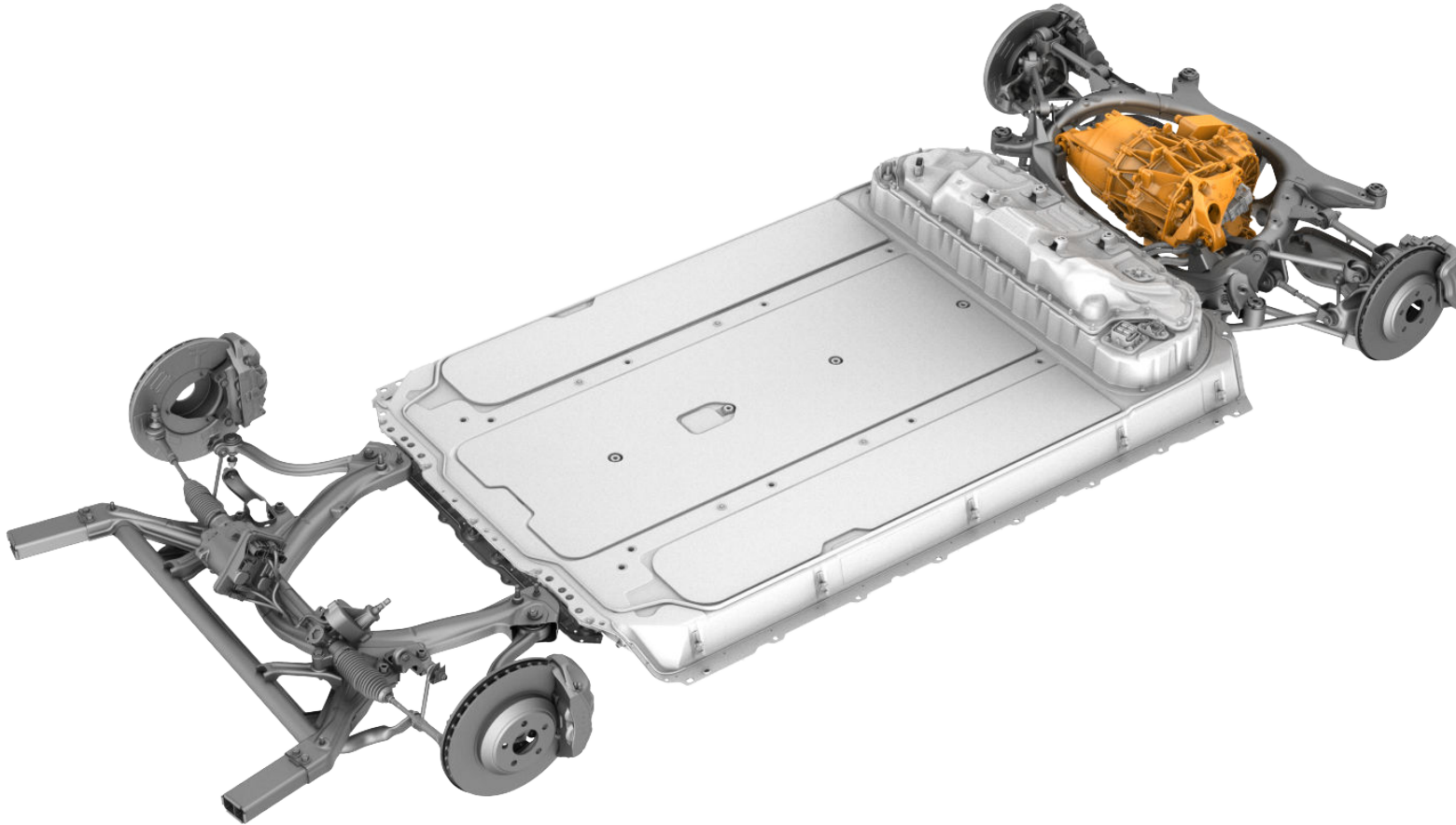



12 VOLT BATTERY

In addition to the high voltage system, Model 3 has a low voltage electrical system. Its 12 volt battery operates the SRS, airbags, windows, door locks, touchscreen, and interior and exterior lights. The high voltage system charges the 12 volt battery, and the 12 volt battery supplies power to the high voltage contactors, allowing high voltage current to flow into and out of the high voltage battery. The 12 volt battery, outlined in red, is located under the hood and the plastic access panel.

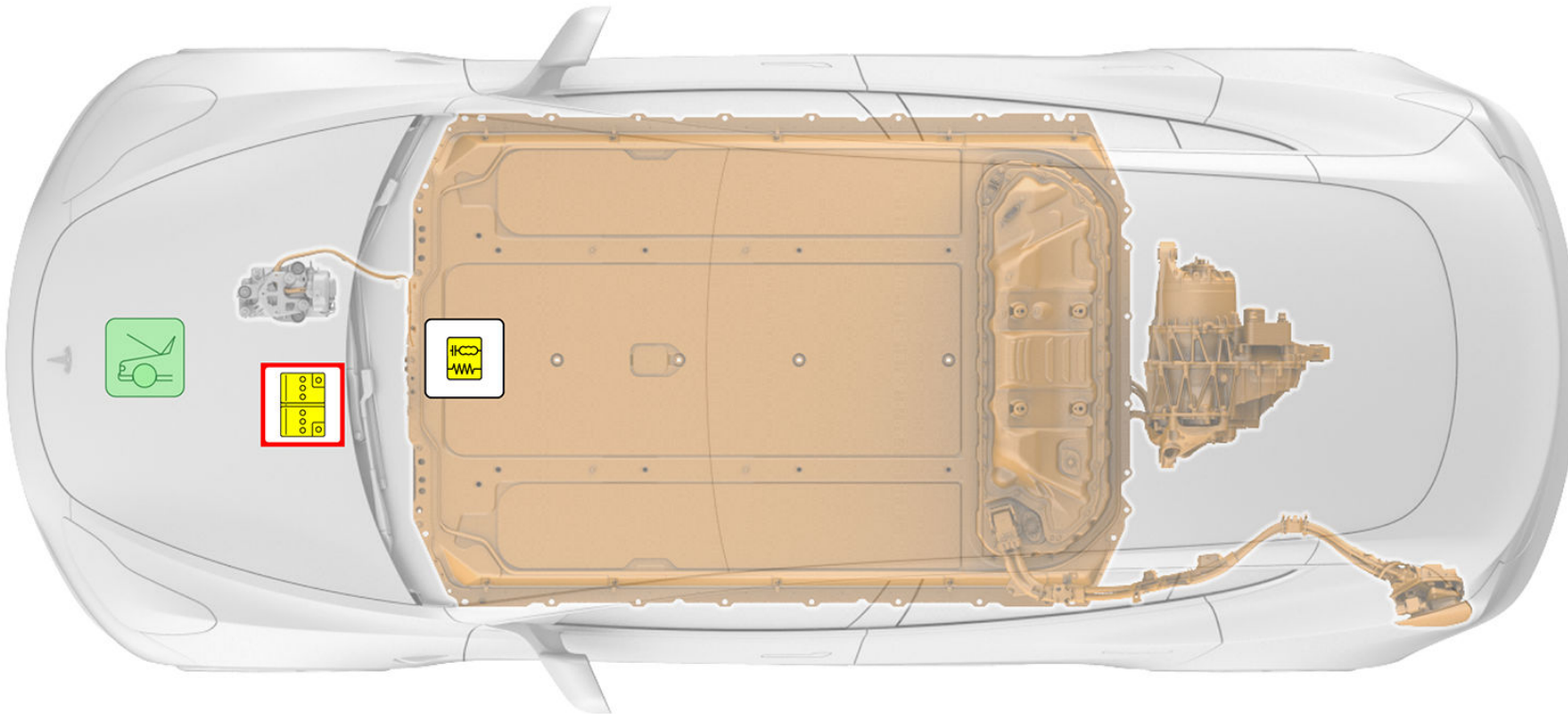



CHOCK ALL FOUR WHEELS

Model 3 moves silently, so never assume it is powered off. Drivers can choose a setting that determines whether or not Model 3 will "creep" when a drive gear is selected. If this setting is off, Model 3 may not move unless the accelerator is pressed, even if shifted into Drive or Reverse. However, never assume that Model 3 will not move. Always chock the wheels.



SHIFT INTO PARK

Model 3 moves silently, so never assume it is powered off. Pressing the accelerator pedal even slightly can cause Model 3 to accelerate quickly if the active gear is Drive or Reverse. To ensure that the parking brake is engaged, press the button on the end of the gear selector to shift into Park. Whenever Model 3 is in Park, the parking brake is automatically engaged and the touchscreen shows the active gear as Park (P).





FRONT TRUNK FIRST RESPONDER CUT LOOP

The first responder loop is a low voltage harness. Cutting the first responder loop shuts down the high voltage system outside of the high voltage battery and disables the SRS and airbag components. Refer to [Cutting the Front Trunk First Responder Loop](#) on page 13 for instructions on how to access and cut the first responder loop.

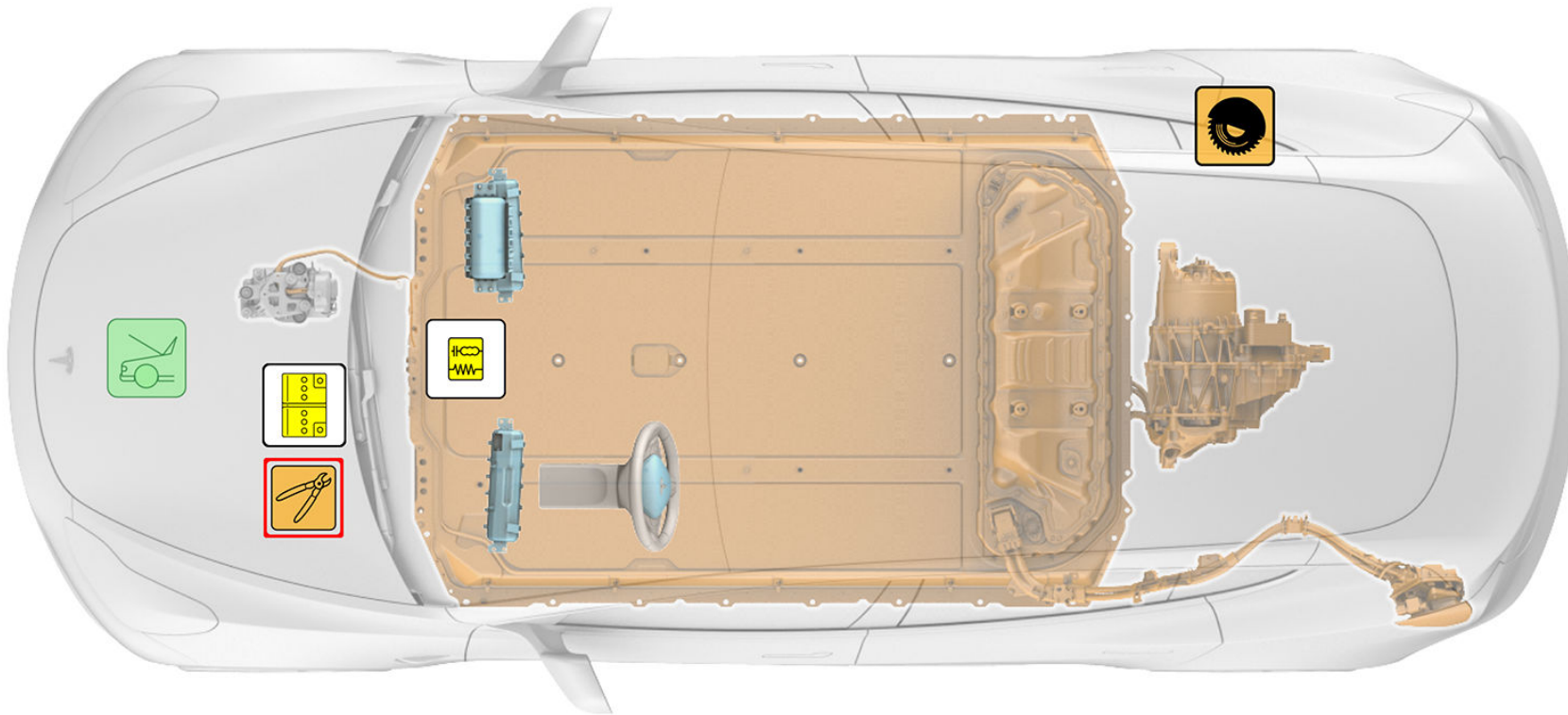

⚠ Warning: Regardless of the disabling procedure you use, ALWAYS ASSUME THAT ALL HIGH VOLTAGE COMPONENTS ARE ENERGIZED! Cutting, crushing, or touching high voltage components can result in serious injury or death.



CUTTING THE FRONT TRUNK FIRST RESPONDER LOOP

When cutting the first responder loop, double cut it to remove an entire section. This prevents the wires from accidentally reconnecting.

1. Open the hood. Refer to [Opening the Hood](#) on page 28 for instructions.

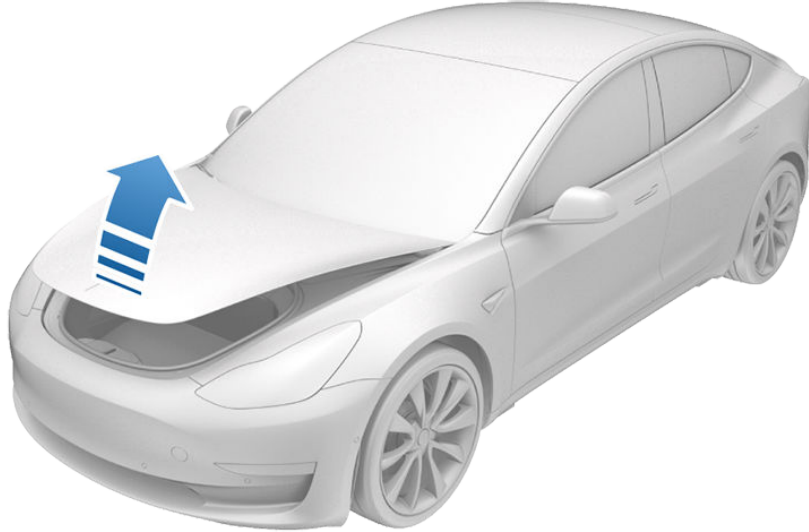

2. Remove the access panel by pulling it upwards to release the clips that hold it in place.

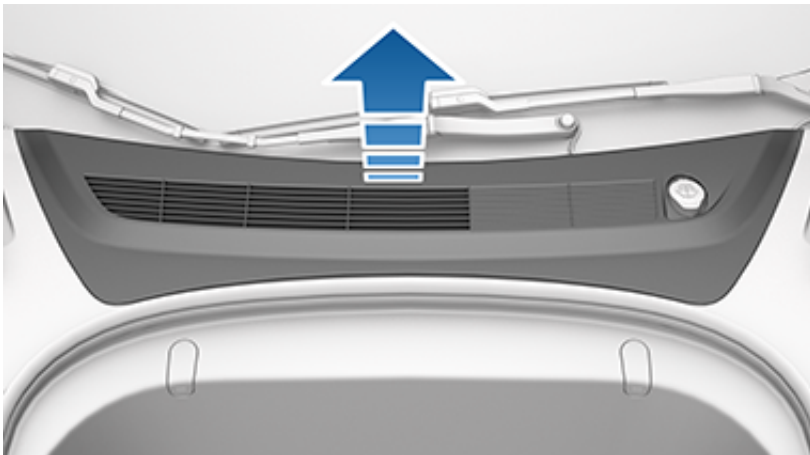



3. Double cut the first responder loop (shown in red).

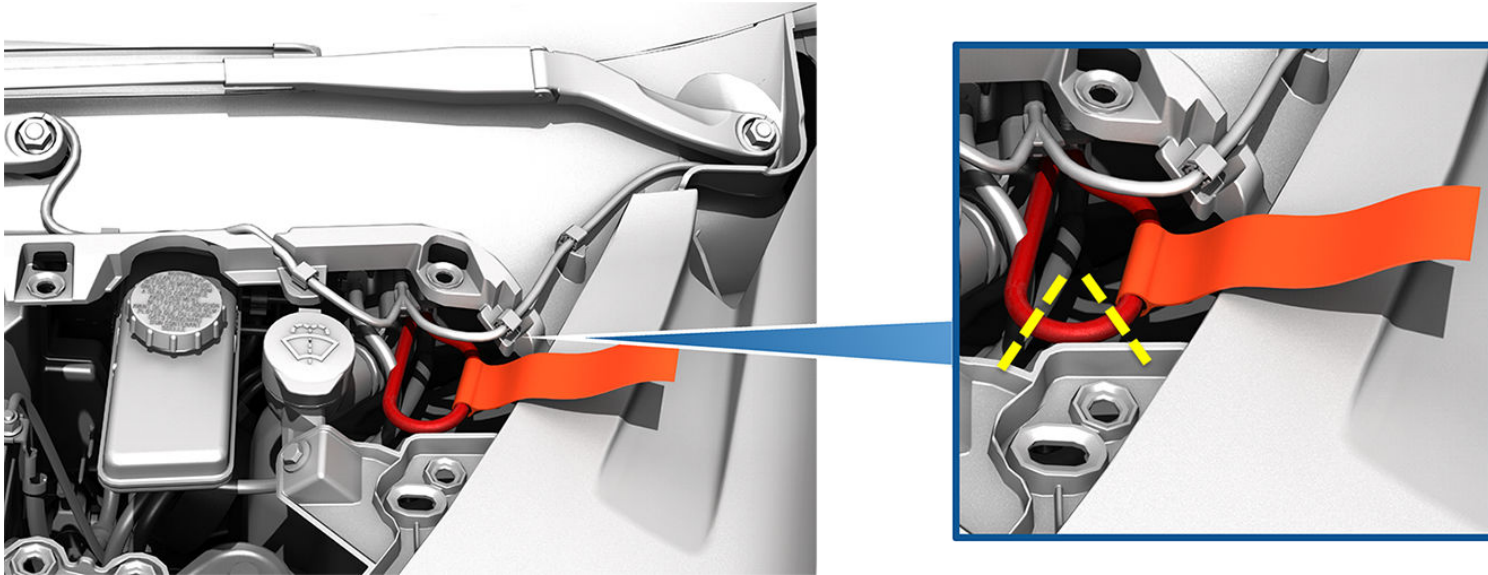



REAR PILLAR FIRST RESPONDER CUT LOOP

If the front trunk first responder cut loop is inaccessible, the rear pillar disconnect point can also shut down the high voltage system outside of the high voltage battery and disable the SRS and airbag components in the same manner. Refer to [Cutting the Rear Pillar First Responder Loop](#) on page 16 for instructions.

NOTE: Only one cut loop needs to be disconnected, not both.

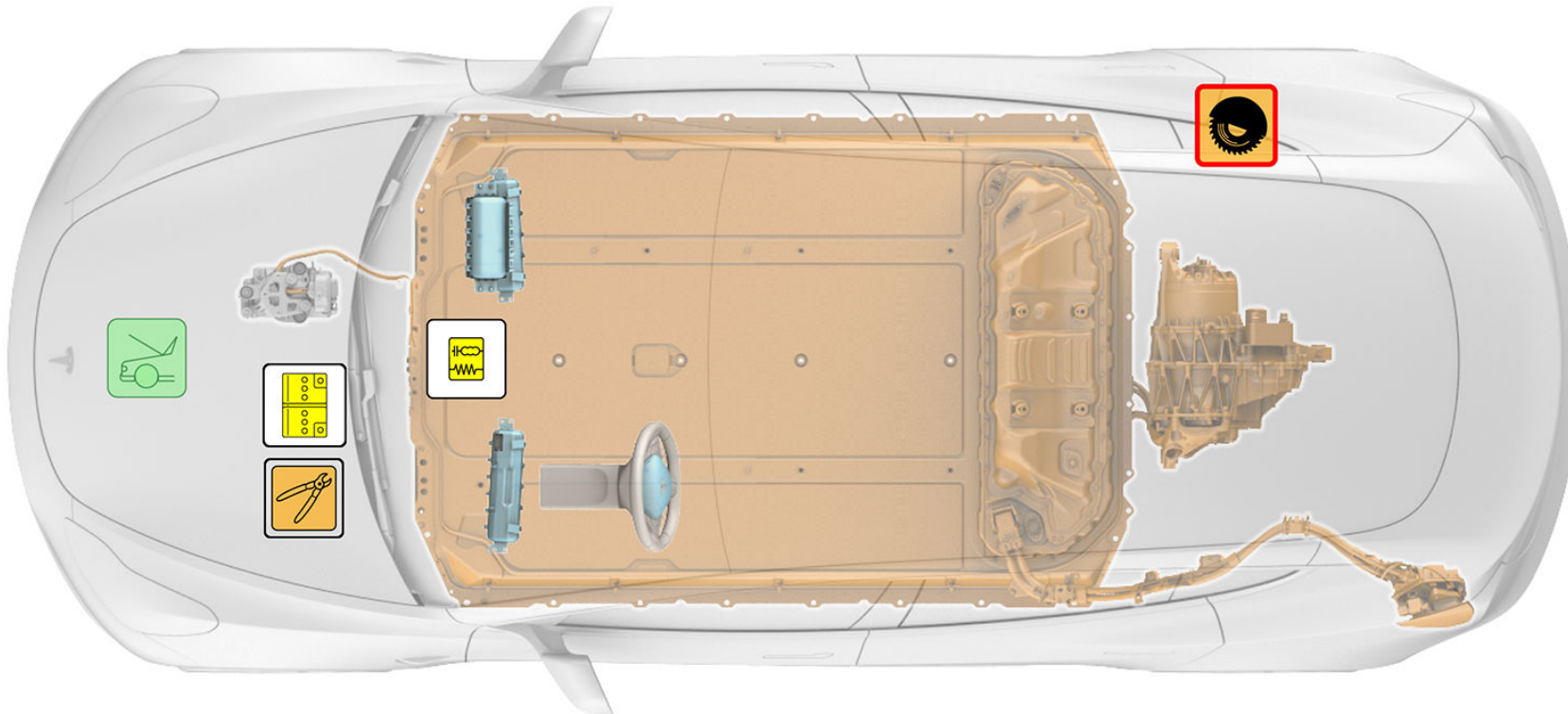

⚠ Warning: Regardless of the disabling procedure you use, ALWAYS ASSUME THAT ALL HIGH VOLTAGE COMPONENTS ARE ENERGIZED! Cutting, crushing, or touching high voltage components can result in serious injury or death.



CUTTING THE REAR PILLAR FIRST RESPONDER LOOP

1. Locate the approximate location of the rear pillar first responder cut loop.

NOTE: The rear pillar cut loop is located on the right side of Model 3 under the trim panel next to the rear fixed glass.

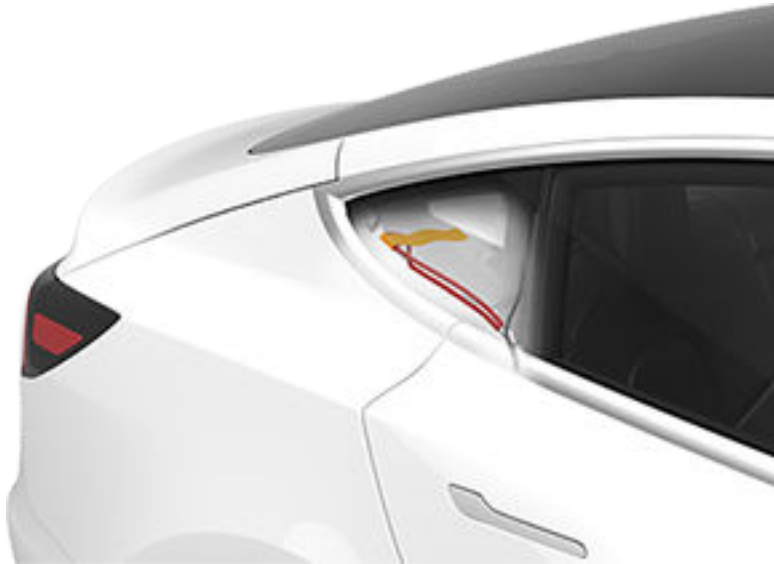

2. Use a reciprocating saw or hydraulic rescue cutters to cut 6 in (15 cm) through the rear pillar in the location shown.

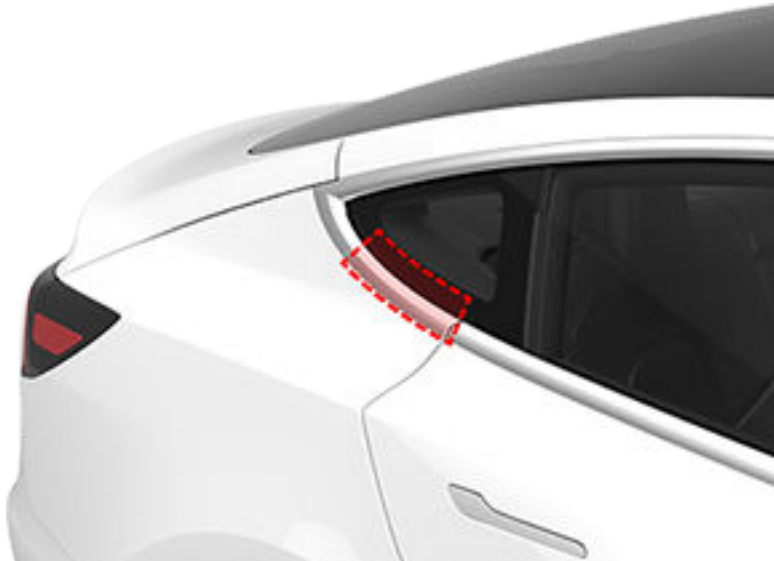



AIRBAGS

Airbags are located in the approximate areas shown. Airbag warning information is printed on the sun visors.

NOTE: Model 3 is designed to deactivate high voltage in all components and cables outside of the high voltage battery when an airbag is deployed.

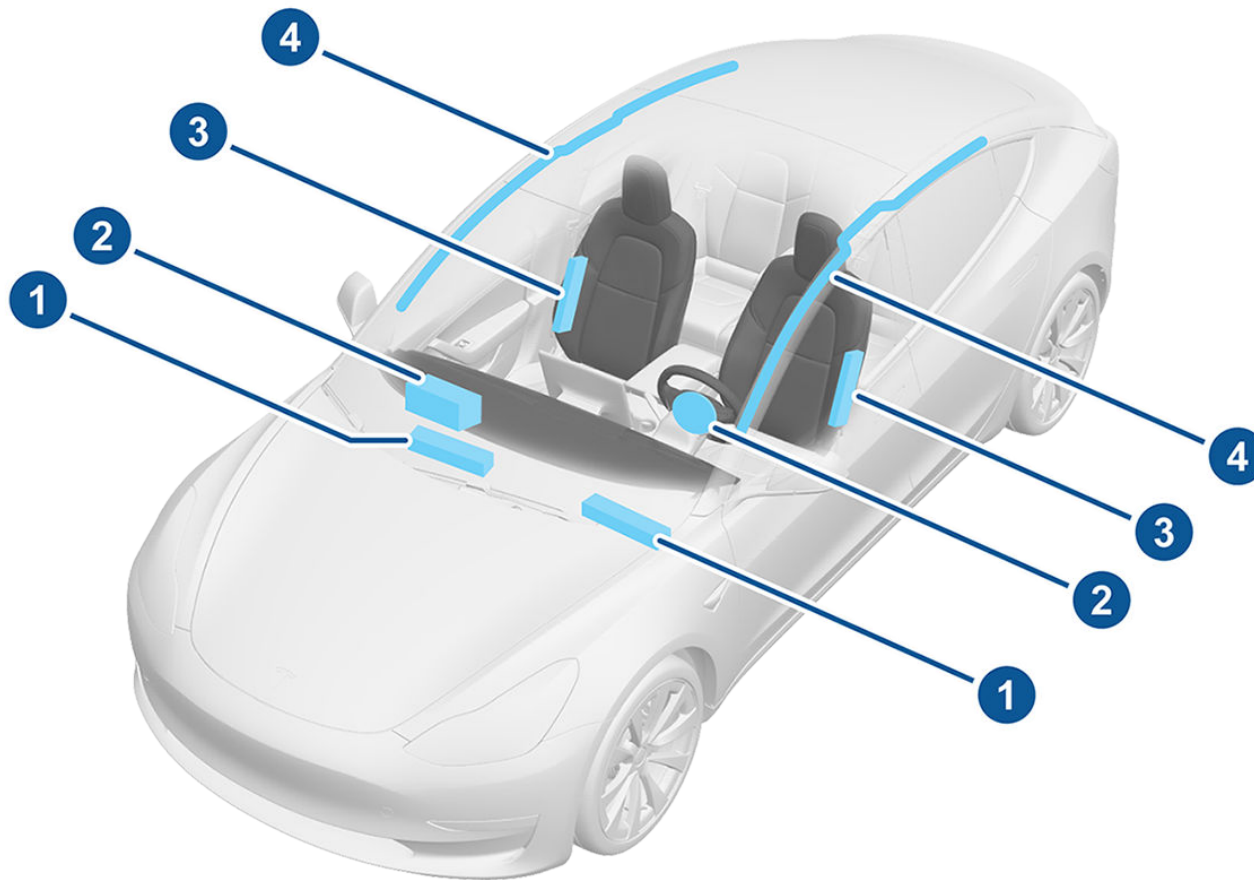

1. Knee airbags
2. Front airbags
3. Seat-mounted side airbags
4. Curtain airbags

⚠ Warning: The SRS control unit has a backup power supply with a discharge time of approximately ten seconds. Do not touch the SRS control unit within 10 seconds of an airbag or pre-tensioner deployment.



AIRBAG INFLATION CYLINDERS

The airbag inflation cylinders, outlined in red, are located near the roof and towards the rear of the vehicle.

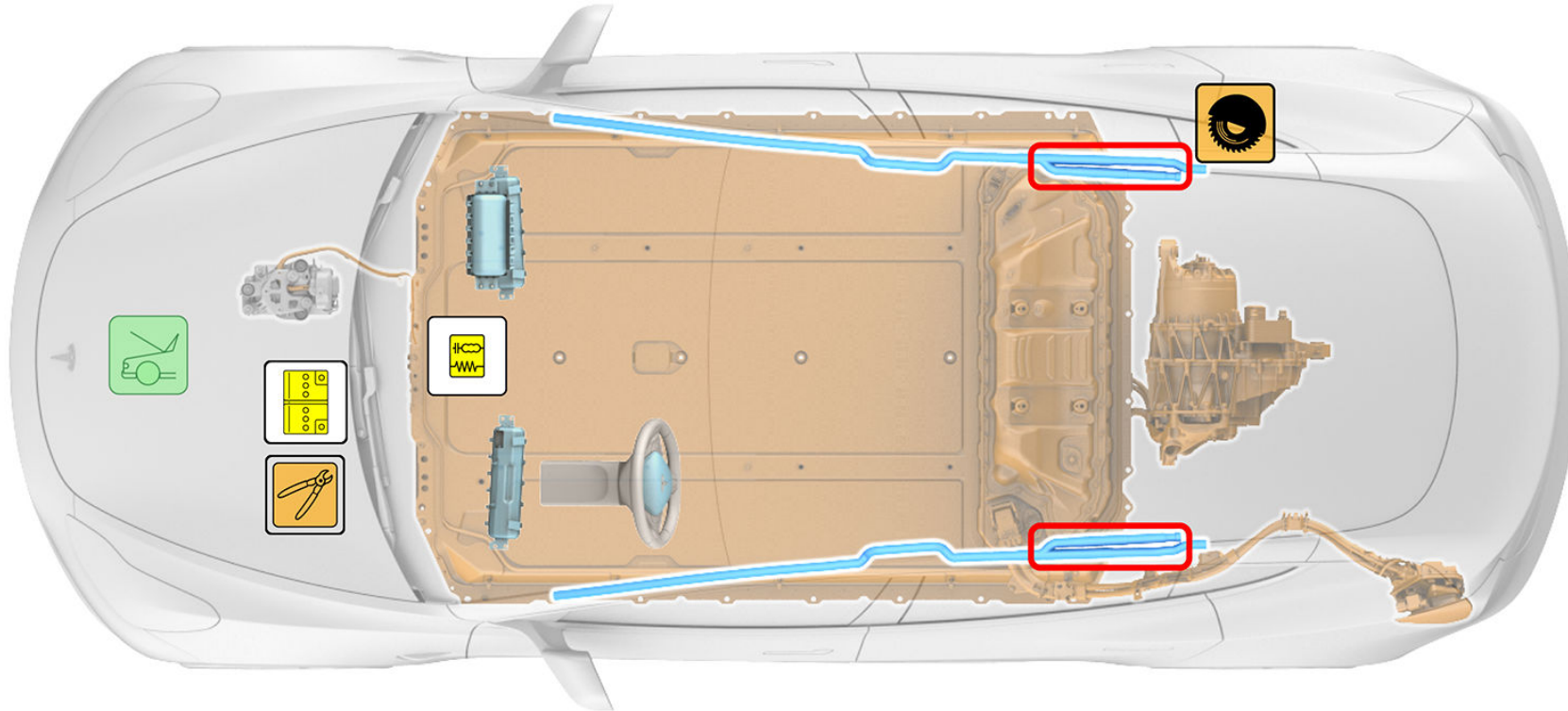

⚠ Warning: The SRS control unit has a backup power supply with a discharge time of approximately ten seconds. Do not touch the SRS control unit within 10 seconds of an airbag or pre-tensioner deployment.



SEAT BELT PRE-TENSIONERS

The seat belt pre-tensioners, outlined in red, are located at the bottom of the B-pillars.

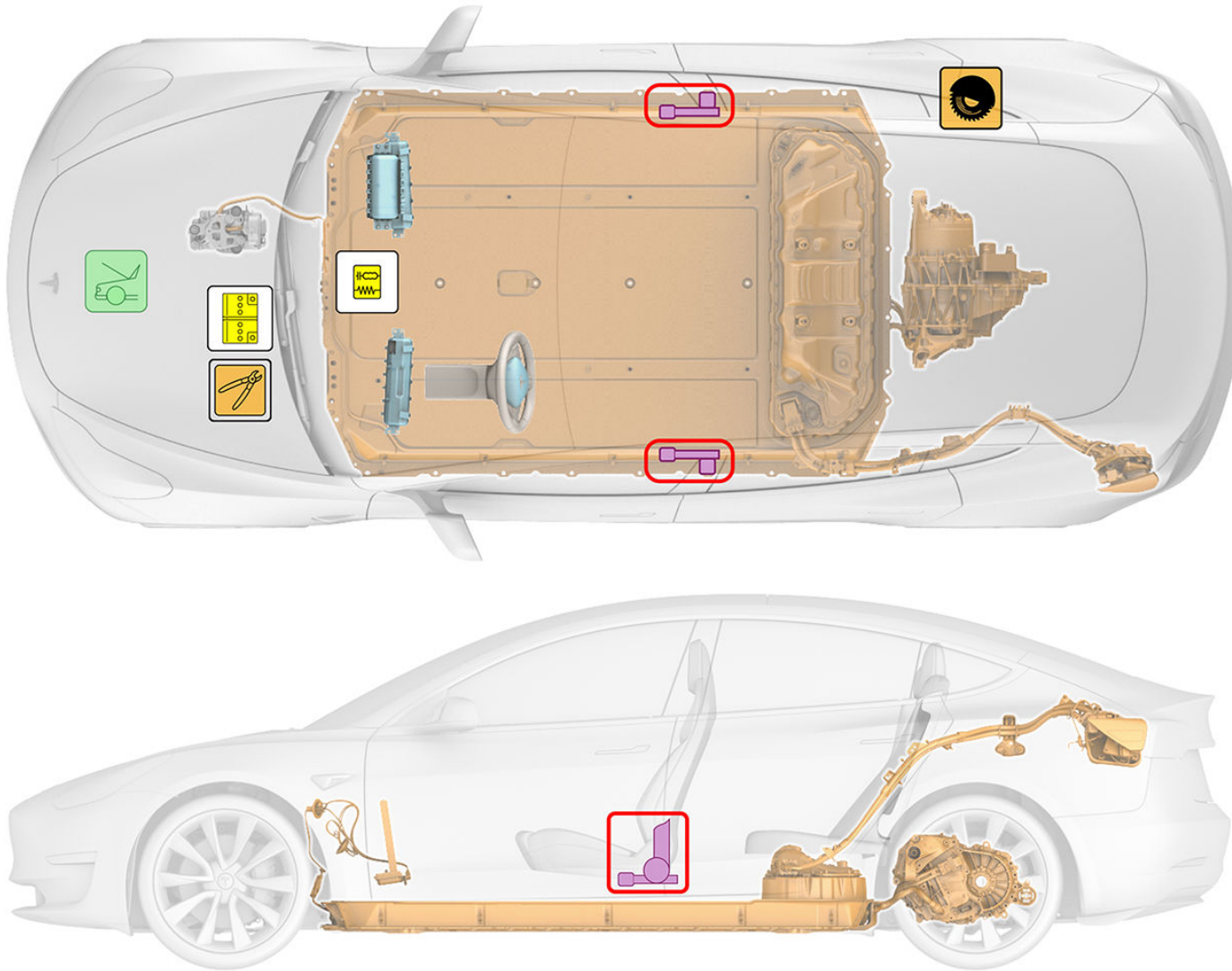

▲ Warning: The SRS control unit has a backup power supply with a discharge time of approximately ten seconds. Do not touch the SRS control unit within 10 seconds of an airbag or pre-tensioner deployment.



REINFORCEMENTS AND ULTRA HIGH STRENGTH STEEL

Model 3 is reinforced to protect occupants in a collision. Suitable tools must be used to cut or crush these areas. Reinforcements are shown in teal below.

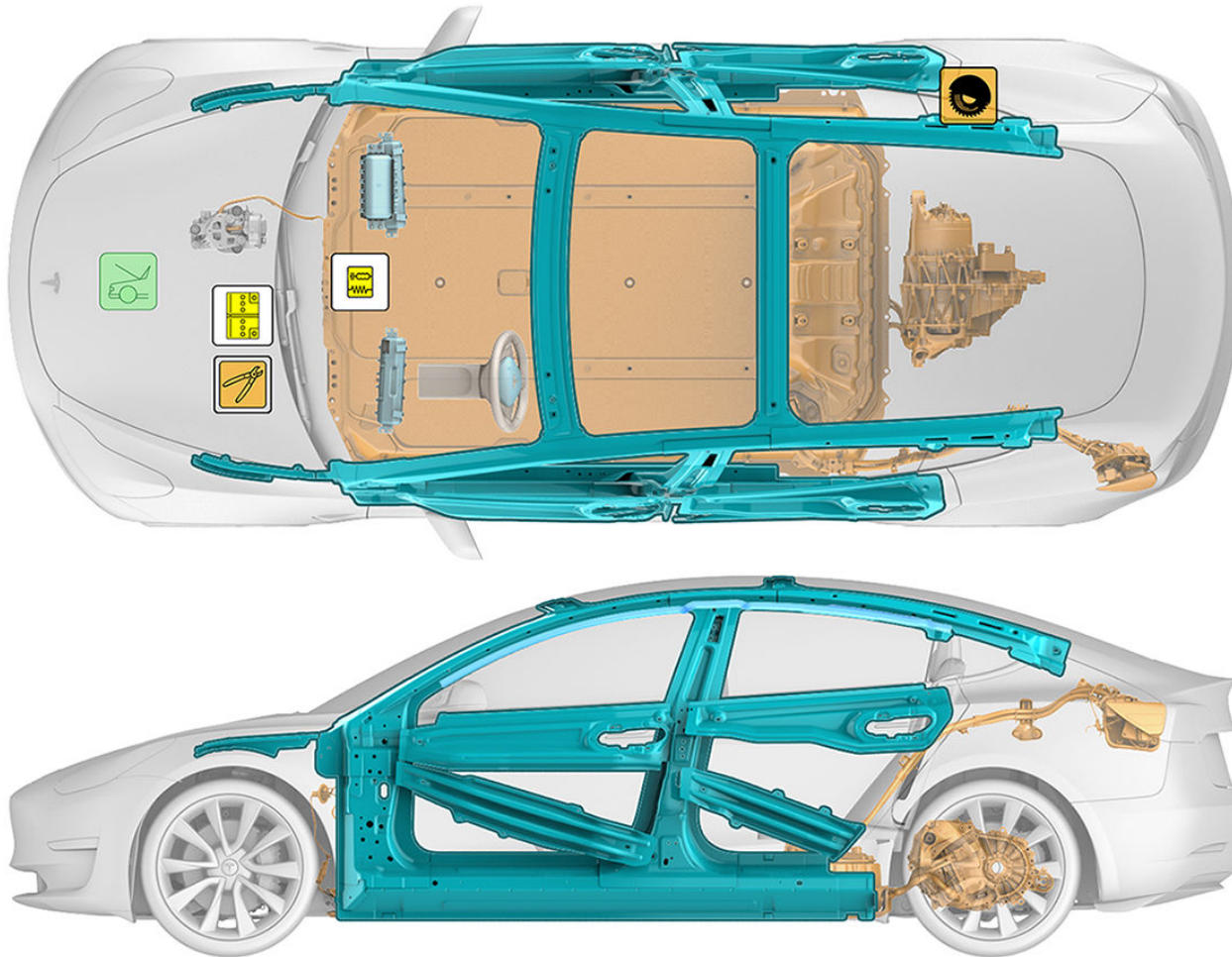

- Warning:** Always use appropriate tools, such as a hydraulic cutter, and always wear appropriate PPE when cutting Model 3. Failure to follow these instructions can result in serious injury or death.
- Warning:** Regardless of the disabling procedure you use, ALWAYS ASSUME THAT ALL HIGH VOLTAGE COMPONENTS ARE ENERGIZED! Cutting, crushing, or touching high voltage components can result in serious injury or death.



NO-CUT ZONES

Model 3 has areas that are defined as "no-cut zones" due to the presence of high voltage, gas struts, SRS components, or other hazards. Never cut or crush in these areas. Doing so could result in serious injury or death. The "no-cut zones" are shown in pink.

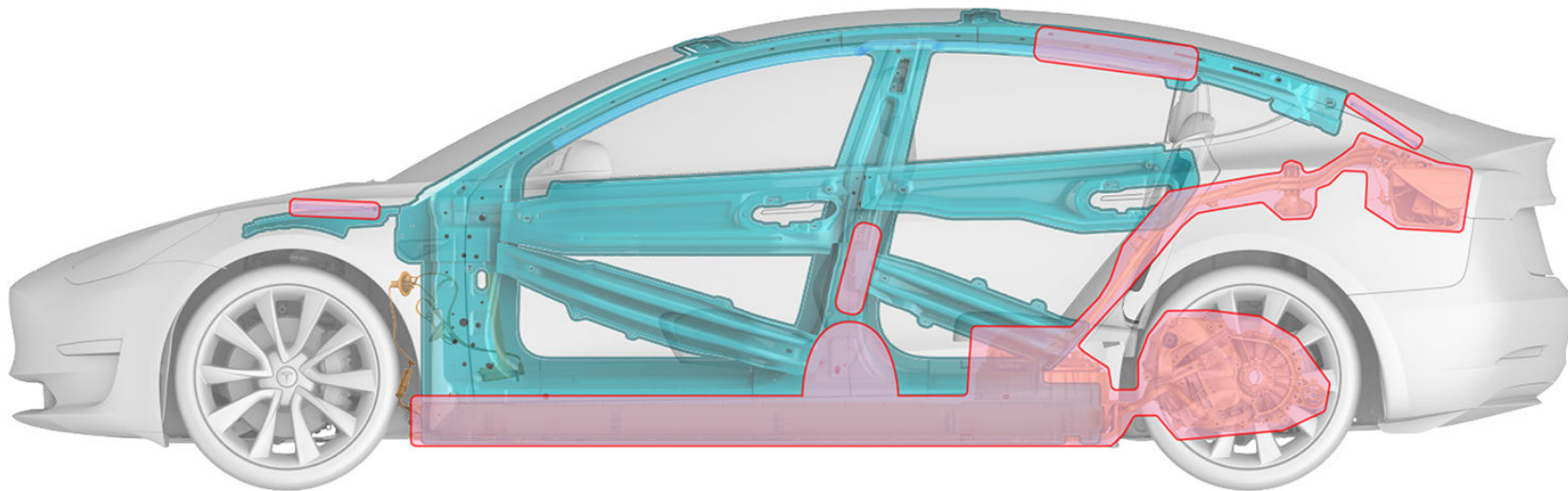

- ▲ **Warning:** Always use appropriate tools, such as a hydraulic cutter, and always wear appropriate PPE when cutting Model 3. Failure to follow these instructions can result in serious injury or death.
- ▲ **Warning:** Regardless of the disabling procedure you use, ALWAYS ASSUME THAT ALL HIGH VOLTAGE COMPONENTS ARE ENERGIZED! Cutting, crushing, or touching high voltage components can result in serious injury or death.



FULLY OR PARTIALLY SUBMERGED VEHICLES

Treat a submerged Model 3 like any other submerged vehicle. The body of Model 3 does not present a greater risk of shock because it is in water. However, handle any submerged vehicle while wearing the appropriate PPE. Remove the vehicle from the water and continue with normal high voltage disabling.

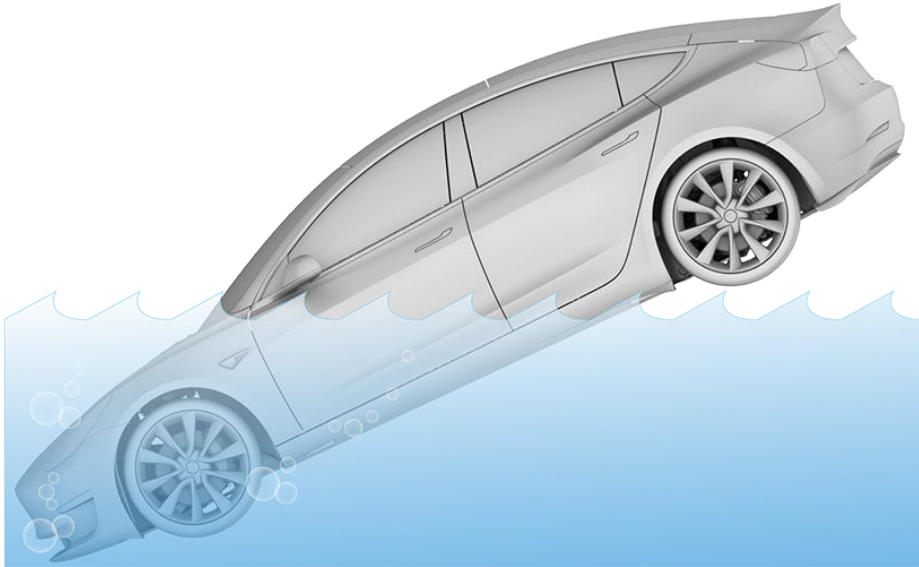

▲ Warning: Handling a submerged vehicle without appropriate PPE can result in serious injury or death.

PUSHING ON THE FLOOR PAN

The high voltage battery is located below the floor pan. Never push on the floor pan inside Model 3. Doing so can breach the high voltage battery or damage the high voltage cables, which can cause serious injury or death.





FIREFIGHTING

USE WATER TO FIGHT A HIGH VOLTAGE BATTERY FIRE. If the battery catches fire, is exposed to high heat, or is generating heat or gases, use large amounts of water to cool the battery. It can take approximately 3,000 gallons of water, applied directly to the battery, to fully extinguish and cool down a battery fire; always establish or request an additional water supply. If water is not immediately available, use dry chemicals, CO₂, foam, or another typical fire-extinguishing agent to fight the fire until water is available.

Extinguish small fires that do not involve the high voltage battery using typical vehicle firefighting procedures.

During overhaul, do not make contact with any high voltage components. Always use insulated tools for overhaul.

Heat and flames can compromise airbag inflators, stored gas inflation cylinders, gas struts, and other components which can result in an unexpected explosion. Perform an adequate knock down before entering a hot zone.

Battery fires can take up to 24 hours to extinguish. Consider allowing the battery to burn while protecting exposures.

After all fire and smoke has visibly subsided, a thermal imaging camera can be used to actively measure the temperature of the high voltage battery and monitor the trend of heating or cooling. There must not be fire, smoke, or heating present in the high voltage battery for at least one hour before the vehicle can be released to second responders (such as law enforcement, vehicle transporters, etc.). The battery must be completely cooled before releasing the vehicle to second responders or otherwise leaving the incident. Always advise second responders that there is a risk of battery re-ignition.

Due to potential re-ignition, a Model 3 that has been involved in a submersion, fire, or a collision that has compromised the high voltage battery should be stored in an open area at least 50 ft (15 m) from any exposure.

▲ Warning: When fire is involved, consider the entire vehicle energized. Always wear full PPE, including a SCBA.

HIGH VOLTAGE BATTERY - FIRE DAMAGE

A burning or heated battery releases toxic vapors. These vapors may include volatile organic compounds, hydrogen gas, carbon dioxide, carbon monoxide, soot, particulates containing oxides of nickel, aluminum, lithium, copper, cobalt, and hydrogen fluoride. Responders should always protect themselves with full PPE, including a SCBA, and take appropriate measures to protect civilians downwind from the incident. Use fog streams or positive-pressure ventilation fans (PPV) to direct smoke and vapors.

The high voltage battery consists of lithium-ion cells. These cells are considered dry cells. If damaged, only a small amount of fluid can leak. Lithium-ion battery fluid is clear in color.

The high voltage battery and drive unit are liquid cooled with a typical glycol-based automotive coolant. If damaged, this blue coolant can leak out of the high voltage battery.

A damaged high voltage battery can create rapid heating of the battery cells. If you notice smoke coming from the high voltage battery, assume that it is heating and take appropriate action as described in [Firefighting](#) on page 23.





LIFT AREAS

The high voltage battery is located under the floor pan. A large section of the undercarriage houses the high voltage battery. When lifting or stabilizing Model 3, only use the designated lift areas, as shown in green.

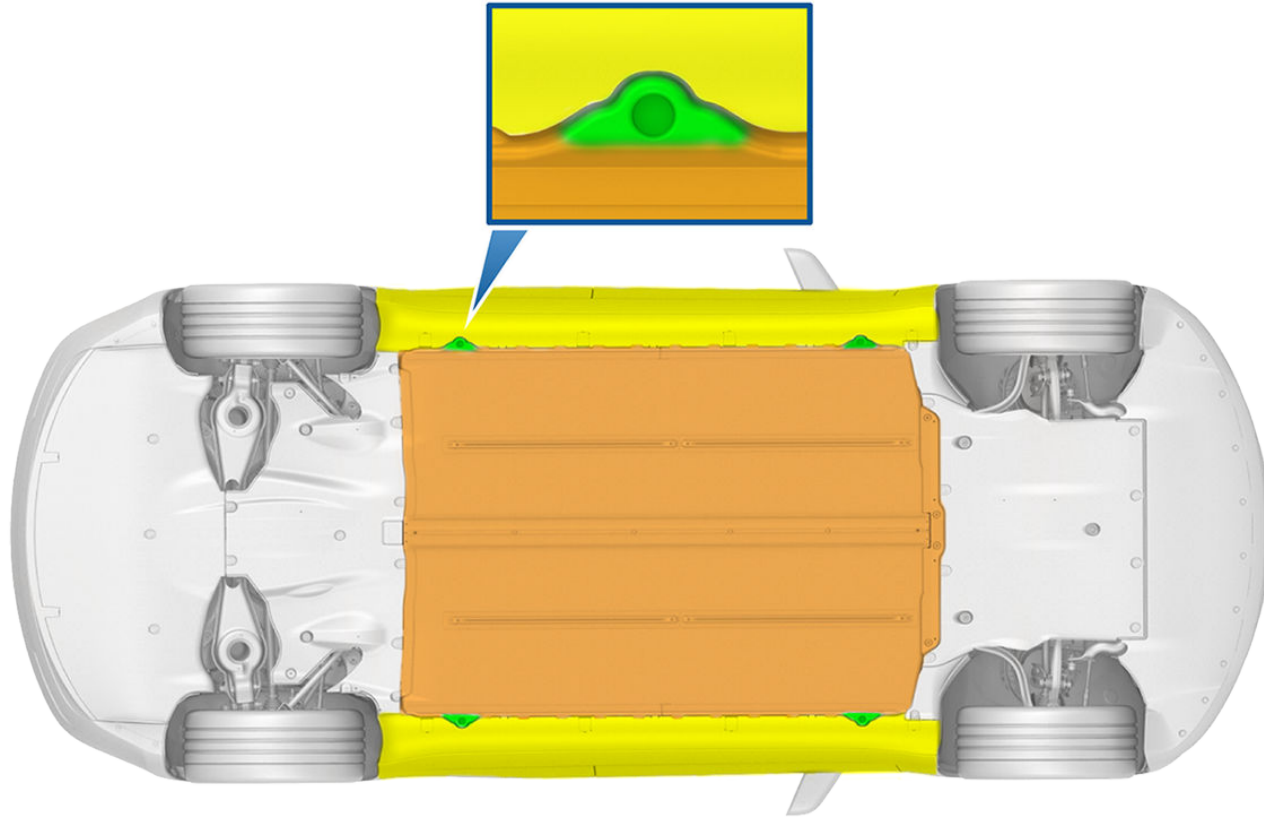
⚠ Warning: DO NOT USE THE HIGH VOLTAGE BATTERY TO LIFT OR STABILIZE MODEL 3.



-  Appropriate lift areas
-  Safe stabilization points for a Model 3 resting on its side
-  High voltage battery



OPENING DOORS FROM THE OUTSIDE

To open the Model 3 doors from the outside, press the wide part of a door handle inwards and then pull the door open.

NOTE: If the door handles do not function, open a front door manually by reaching inside the window and using the mechanical release handle. See [Opening Front Doors Without Power](#) on page 27.





OPENING DOORS FROM THE INSIDE WITH POWER

To open the Model 3 doors from the inside with 12 volt power enabled, press the button located near the door panel.

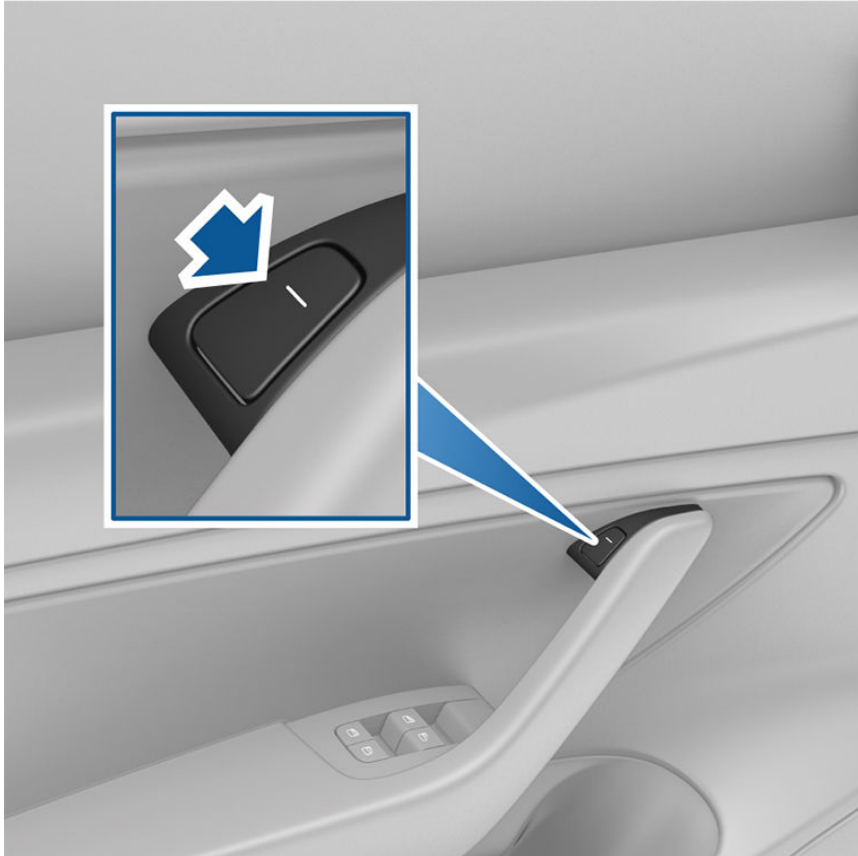



OPENING FRONT DOORS WITHOUT POWER

To open the Model 3 front doors from the inside without 12 volt power, lift the mechanical release handle located near the window switches.

NOTE: Only the front doors are equipped with a mechanical release handle.





OPENING THE HOOD

Model 3 does not have a traditional internal combustion engine. Therefore, the area that would normally house the engine is used as additional storage space. Tesla calls this area the “Front Trunk”.

To open the hood with 12 volt power enabled, touch the associated OPEN button on the touchscreen.

To open the hood without 12 volt power:

NOTE: The following steps will not open the front trunk if Model 3 has 12 volt power enabled.

1. Locate an external 12 volt power supply.
2. Release the tow eye cover by pressing firmly on the top right perimeter of the cover until it pivots inward, then pulling the raised section toward you.

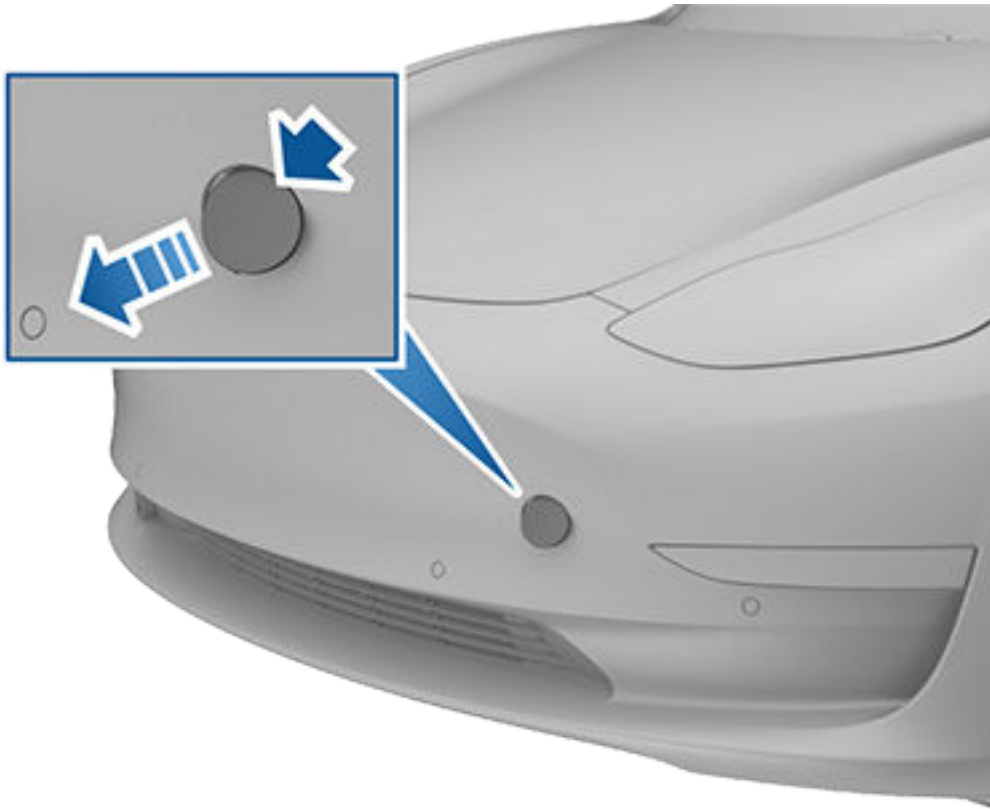



3. Pull the two wires out of the tow eye opening to expose the vehicle-side terminals.

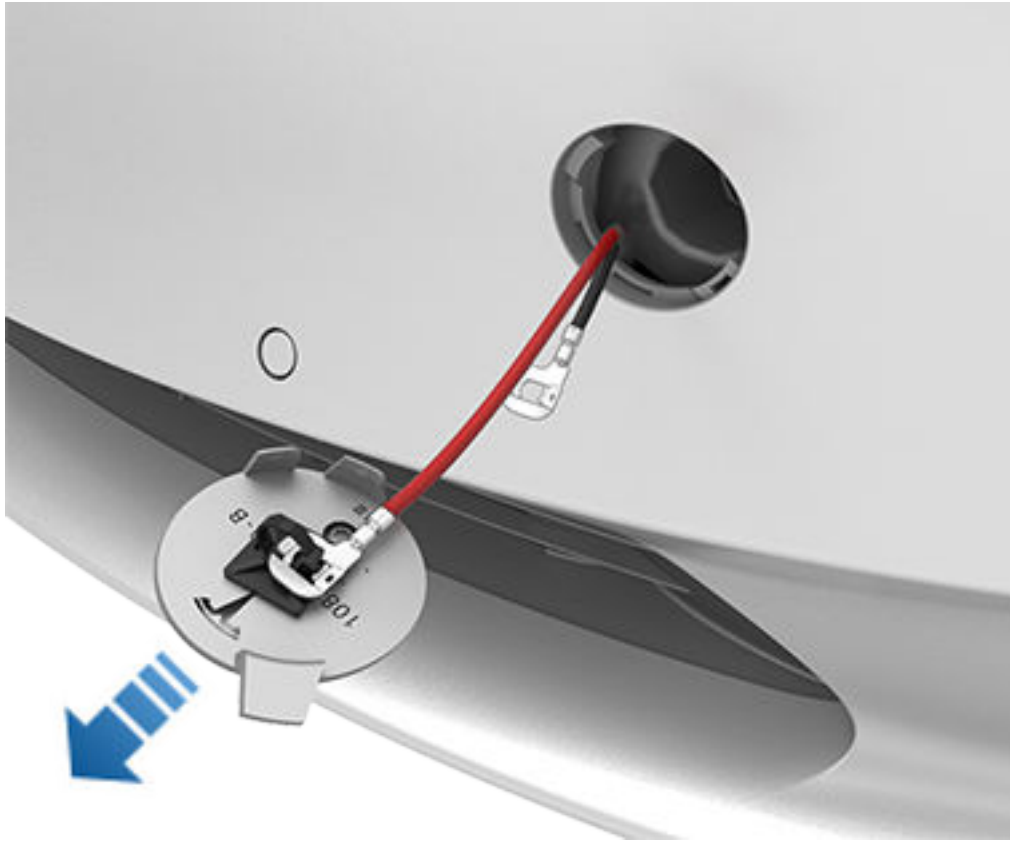

4. Connect the external 12 volt power supply's red positive (+) cable to the red positive (+) vehicle-side terminal.



5. Connect the external 12 volt power supply's black negative (-) cable to the black negative (-) vehicle-side terminal.

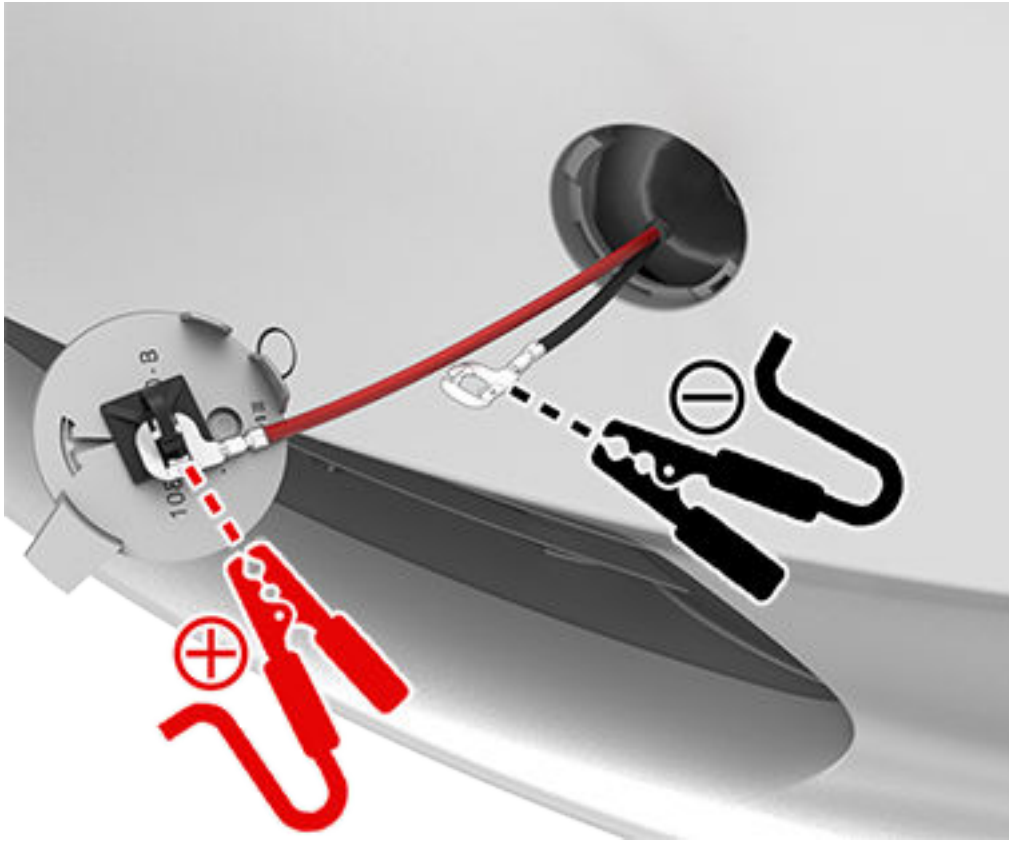

6. Turn on the external power supply (refer to the external power supply manufacturer's instructions). The hood latches are immediately released and you can now open the hood to access the front trunk area.
7. Disconnect both external power supply cables, beginning with the black negative (-) cable.



OPENING THE TRUNK

Use one of the following methods to open the trunk:

- Touch the associated OPEN button on the touchscreen.
- Press the switch located under the exterior handle on the trunk.

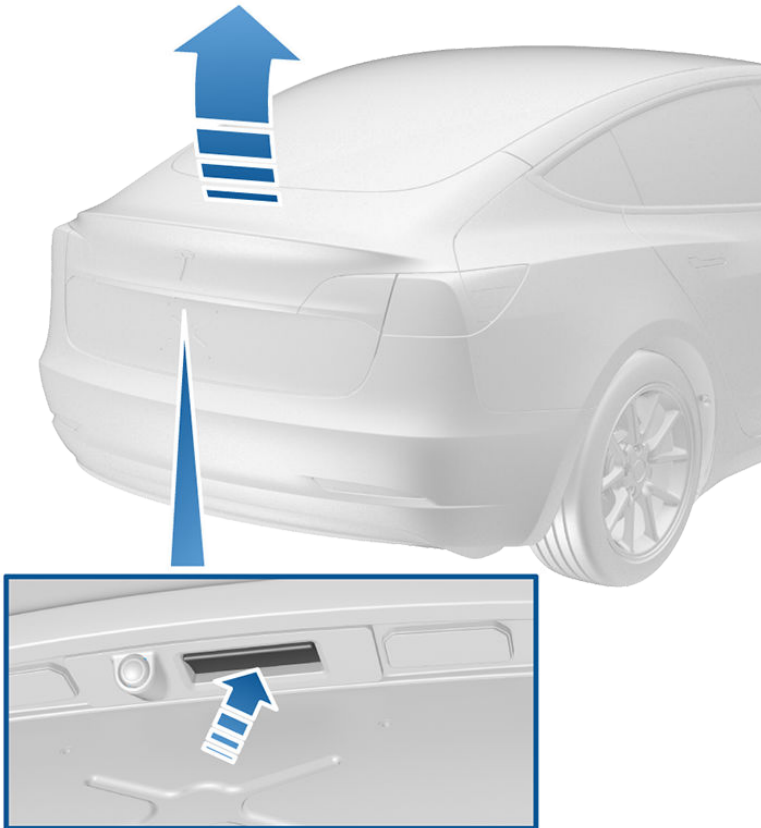



PUSHING THE VEHICLE

▲ Warning: Refer to the Owner's Manual on the touchscreen or the Roadside Assistance Guide in the glovebox for instructions on how to transport Model 3. The following instructions are intended to be used when only moving Model 3 a very short distance to improve traffic safety. Damage caused by transporting the vehicle is not covered by the warranty.

In situations where there is minimal risk of fire or high voltage exposure (for example, the vehicle does not accelerate after coming to a stop at an intersection) and 12V power is present, Model 3 can be quickly pushed in order to clear the roadway. If a driver is present, simply shift Model 3 into Neutral and then push the vehicle. If a driver is not present, Model 3 may automatically shift into Park when it detects the driver leaving the vehicle (even if it has previously been shifted into Neutral).

To keep Model 3 in Neutral (which disengages the parking brake and allows the vehicle to be pushed) without a driver present, use the touchscreen to activate Transport Mode:

1. Shift Model 3 into Park.
2. Press and hold the brake pedal, then on the touchscreen touch Controls > Service > Towing.
3. Hold the Transport Mode button until it turns blue. Model 3 is now free-rolling.

To cancel Transport Mode, shift Model 3 into Park.

NOTE: Transport Mode automatically cancels and the parking brake is applied if Model 3 is rolled faster than 5 mph (8 km/h), 12V power becomes low or absent, or if Transport Mode has been continuously enabled for 20 minutes. Model 3 sounds its horn if Transport Mode is about to cancel.

NOTE: If Model 3 cannot detect the key (an authenticated smartphone or key card), the Transport Mode button is grayed out and Transport Mode cannot be enabled. Call Tesla Roadside Assistance.

NOTE: The touchscreen is unresponsive if Model 3 has no 12V power. Use an external 12V power to open the hood and jump start the vehicle's auxiliary 12V battery. Refer to the Roadside Assistance Guide in the glovebox (touch Controls > Glovebox) or call Tesla Roadside Assistance for instructions.



EXAMPLE OF A HIGH VOLTAGE LABEL

An example of a label located on a high voltage component is shown below. Note that, depending on the region, these labels might be translated into other languages.

⚠ Warning: Not every high voltage component is labeled. Always wear appropriate PPE when cutting Model 3. Failure to follow these instructions can result in serious injury or death.

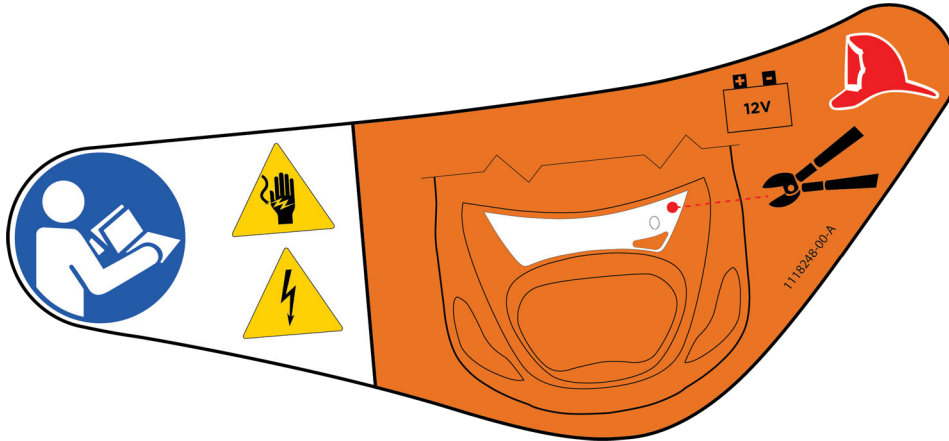

**A**

airbag inflation cylinders [18](#)
airbags [17](#)

B

badging [3](#)
battery
 12 volt [10](#)
 high voltage [7](#)

C

cut loop, front trunk [12](#)
cut loop, rear pillar [15](#)
cutting the front trunk cut loop [13](#)
cutting the rear pillar cut loop [16](#)

F

firefighting [23](#)
fires [23](#)

H

high voltage components
 battery [7](#)
 cables [8](#)
 drive unit [9](#)
 overview [6](#)
hood, opening [28](#)

I

identifying the vehicle [3-5](#)

L

labels, high voltage [33](#)
lifting the vehicle [24](#)

N

no cut zones [21](#)

P

park gear [11](#)
pushing the vehicle [32](#)

R

reinforcements, location of [20](#)
rescue operations
 firefighting [23](#)
 submerged vehicles [22](#)

S

seat belt pre-tensioners [19](#)
second responders [23](#)
smoke [23](#)
stabilization points (jacking) [24](#)
stabilizing the vehicle [11](#)
submerged vehicles [22](#)

T

Transport Mode [32](#)
trunk, opening [31](#)

V

vehicle identification number [4](#)

W

wheels, chocking [11](#)

TESLA

©2012-2017 TESLA, INC.

All information in this document and all vehicle software is subject to copyright and other intellectual property rights of Tesla, Inc. and its licensors. This material may not be modified, reproduced or copied, in whole or in part, without the prior written permission of Tesla, Inc. and its licensors. Additional information is available upon request. The following are trademarks or registered trademarks of Tesla, Inc. in the United States and other countries:

TESLA TESLA MOTORS TESLA
ROADSTER

MODEL S MODEL X MODEL 3

TESLA

