

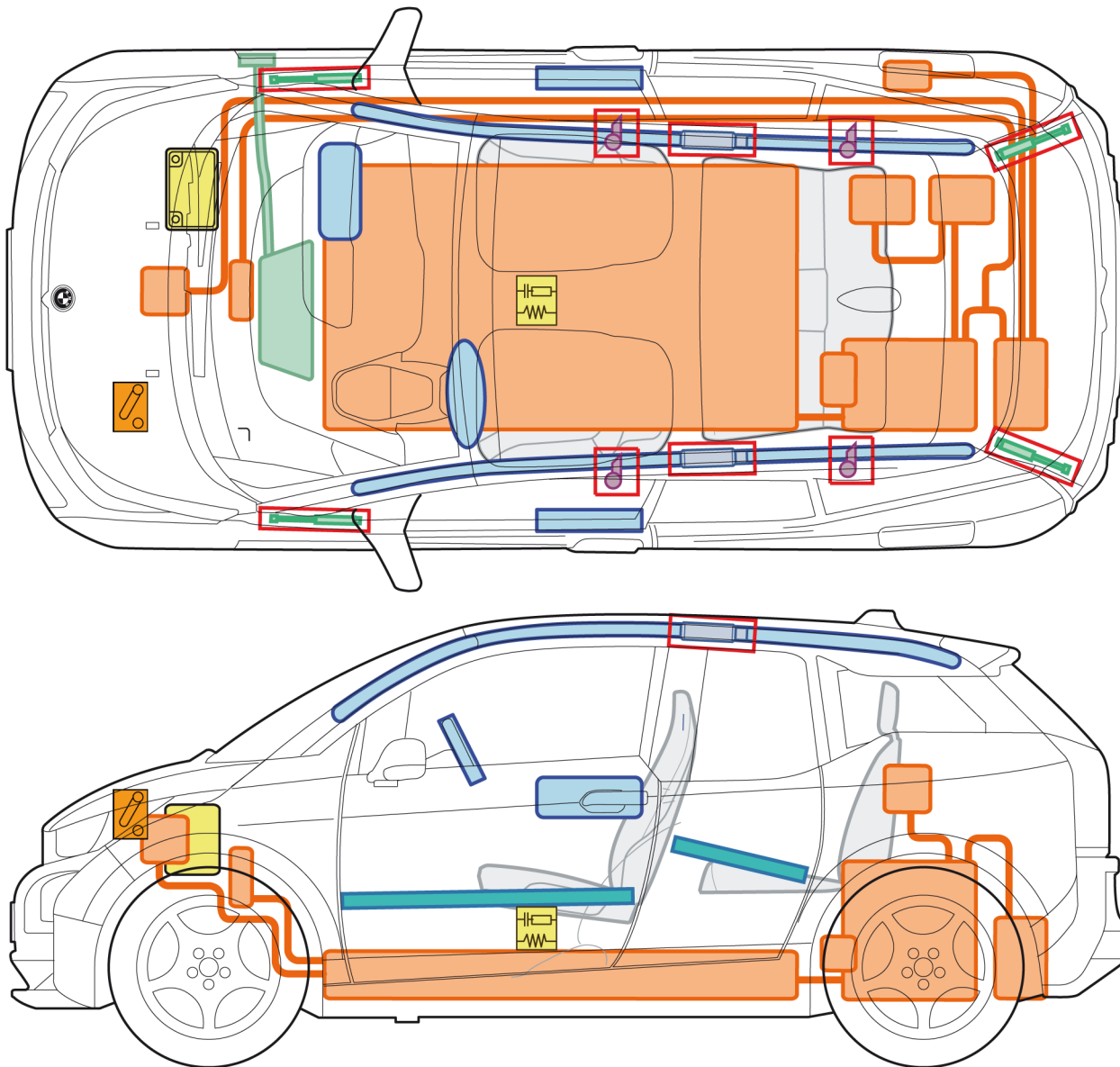

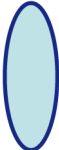









i3
(from 11/2013)



Legend

	Airbag		Body reinforcement		Airbag control unit		High-voltage emergency separation point
	Gas generator		Gas-filled shock absorber		12 V battery		
	Belt tensioner		Fuel tank		High-voltage components		

This overview shows the maximum possible vehicle equipment.



Danger to life!

Do not touch high-voltage components!

Special features:

High-voltage system with direct current voltage up to 1000 volts!

Secure vehicle to prevent it rolling.



Press "P" button.



Pull the switch for the electrical Automatic Hold brake up.



Airbag activated

The high-voltage system is automatically deactivated (de-energised) if an accident is experienced that triggers the airbags.

Deactivate the electric motor and high-voltage system (switch to de-energised) – airbag not activated.
(START-STOP and 12 V battery accessible)



1. Press the START-STOP button, the system switches off.



Open the engine compartment lid and remove the cover (1).

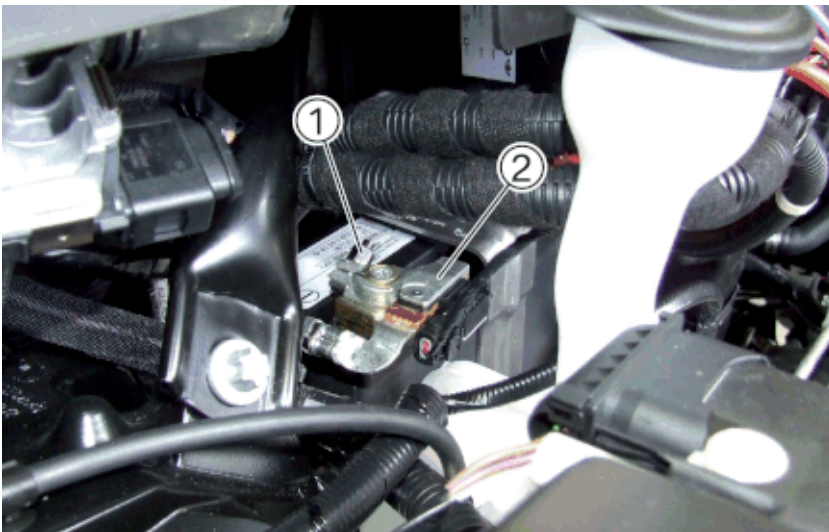

Slacken the nut (1) and pull off the battery earth lead (2) in the upwards direction.



Remove the cover (1).

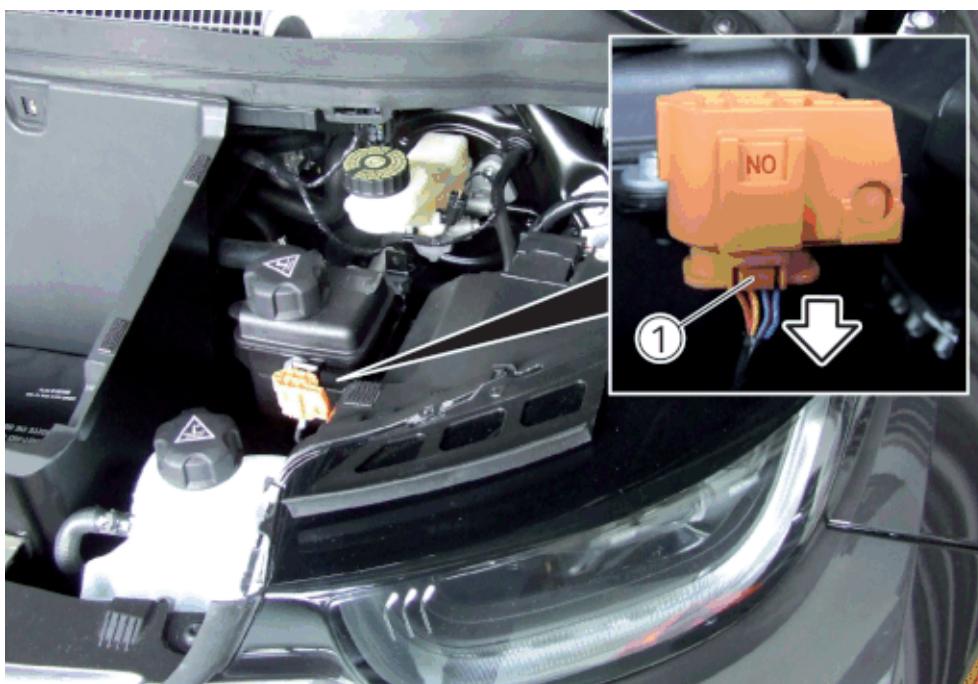

Unlock connector for high-voltage emergency separation point (1) and pull apart in direction of arrow.

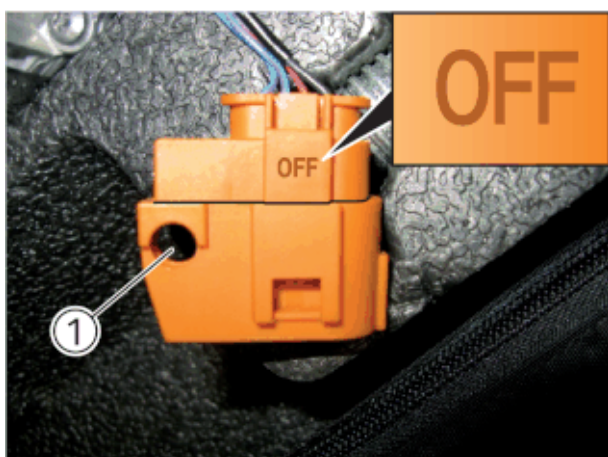

The high-voltage system is deactivated when bore hole (1) is completely free and the word "OFF" can be seen on the connector.

For example, you can install a padlock through the open bore hole (1) to prevent unintended activation of the high-voltage system!

Note: The plug connection cannot be fully disconnected.

The high-voltage battery is located on the vehicle underbody.

Identification of high-voltage battery:

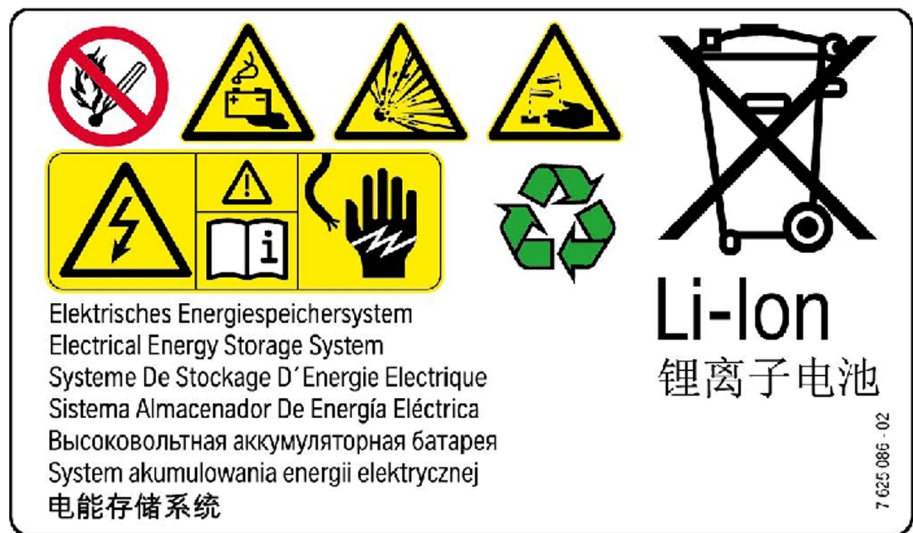

Identification of the remaining high-voltage components:



Identification of the high-voltage cable (1) (insulation / orange coating).

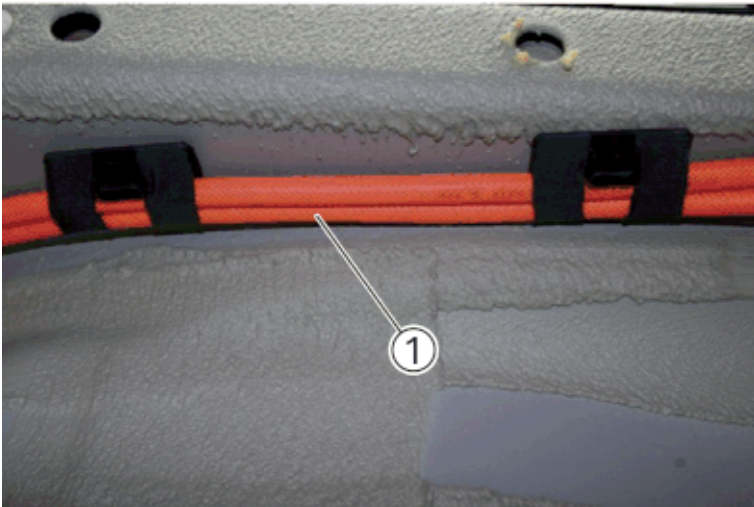

Opening the vehicle

These notes apply exclusively to trained emergency service personnel. Knowledge of the function and operating principle of the safety systems and vehicle characteristics is also needed.

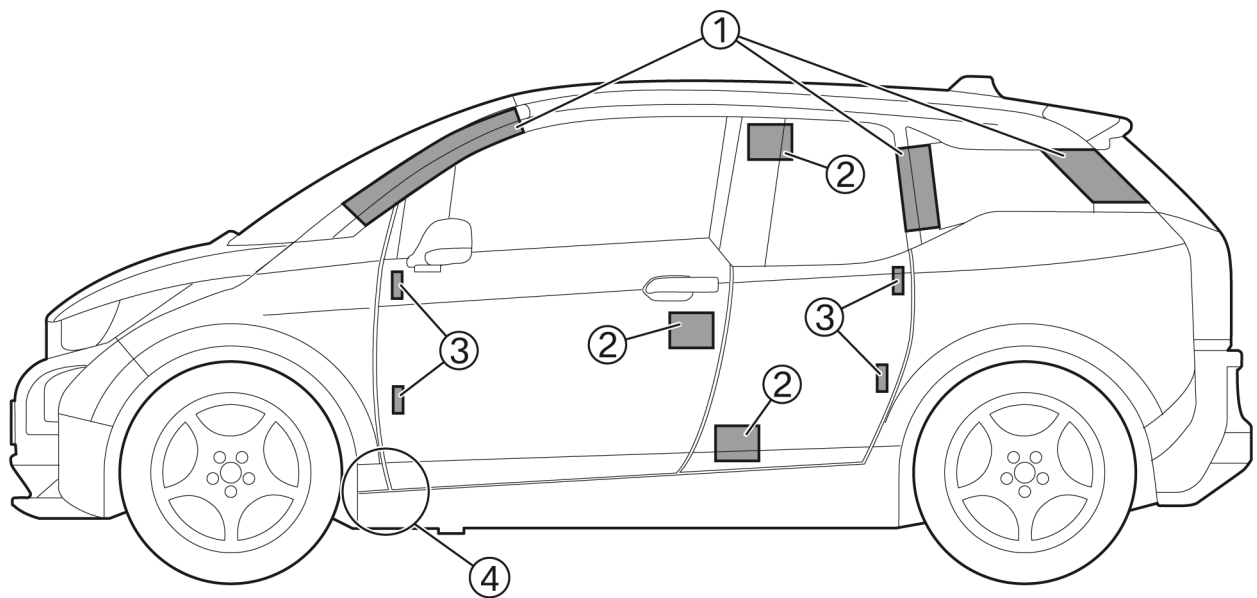

1. The areas mark the zones at which the roof can be cut off.

Modern heavy duty cutting equipment is mandatory for cutting the body; older hydraulic cutting tools could be overloaded.

The heavy duty cutting equipment must be properly used by trained and qualified personnel.

- 2. Door locks
- 3. Door hinges
- 4. Release step area

Important information

Further information is given in the expert guide that is an element of the rescue manual. The information for the rescue personnel must be complied with.