

Foreword

E09200105565

Thank you for selecting a MITSUBISHI MOTORS product as your new vehicle.

This owner's manual will add to your understanding and full enjoyment of the many fine features of this vehicle.

It contains information prepared to acquaint you with the proper way to operate and maintain your vehicle for the utmost in driving pleasure.

MITSUBISHI MOTORS AUSTRALIA LTD., reserves the right to make changes in design and specifications and/or to make additions to or improvements in this product without obligation to install them on products previously manufactured.

It is an absolute requirement for the driver to strictly observe all laws and regulations concerning vehicles.

This owner's manual has been written in compliance with such laws and regulations, but some of the contents may become contradictory with later amendment of the laws and regulations.

Please leave this owner's manual in this vehicle at time of resale. The next owner will appreciate having access to the information contained in this owner's manual.



Throughout this owner's manual the words **WARNING** and **CAUTION** appear.

These serve as reminders to be especially careful. Failure to follow instructions could result in personal injury or damage to your vehicle.

WARNING

indicates a strong possibility of severe personal injury or death if instructions are not followed.

CAUTION

means hazards or unsafe practices that could cause minor personal injury or damage to your vehicle.

You will see another important symbol:

NOTE: gives helpful information.

***: indicates optional equipment.**

It may differ according to the sales classification; refer to the sales catalogue.

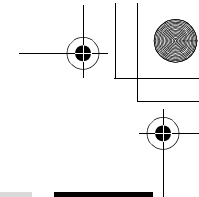
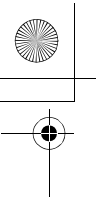
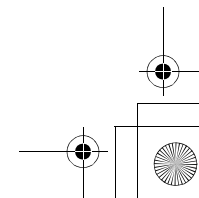
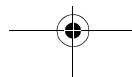
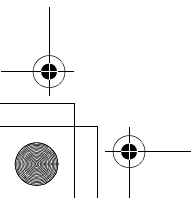
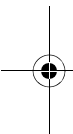

Table of contents

Overview	1
General information	2
Charging	3
Locking and unlocking	4
Seat and seat belts	5
Instruments and controls	6
Starting and driving	7
For pleasant driving	8
For emergencies	9
Vehicle care	10
Maintenance	11
Specifications	12
Alphabetical index	13



Instruments and Controls

1

Instruments and Controls

E00100108168

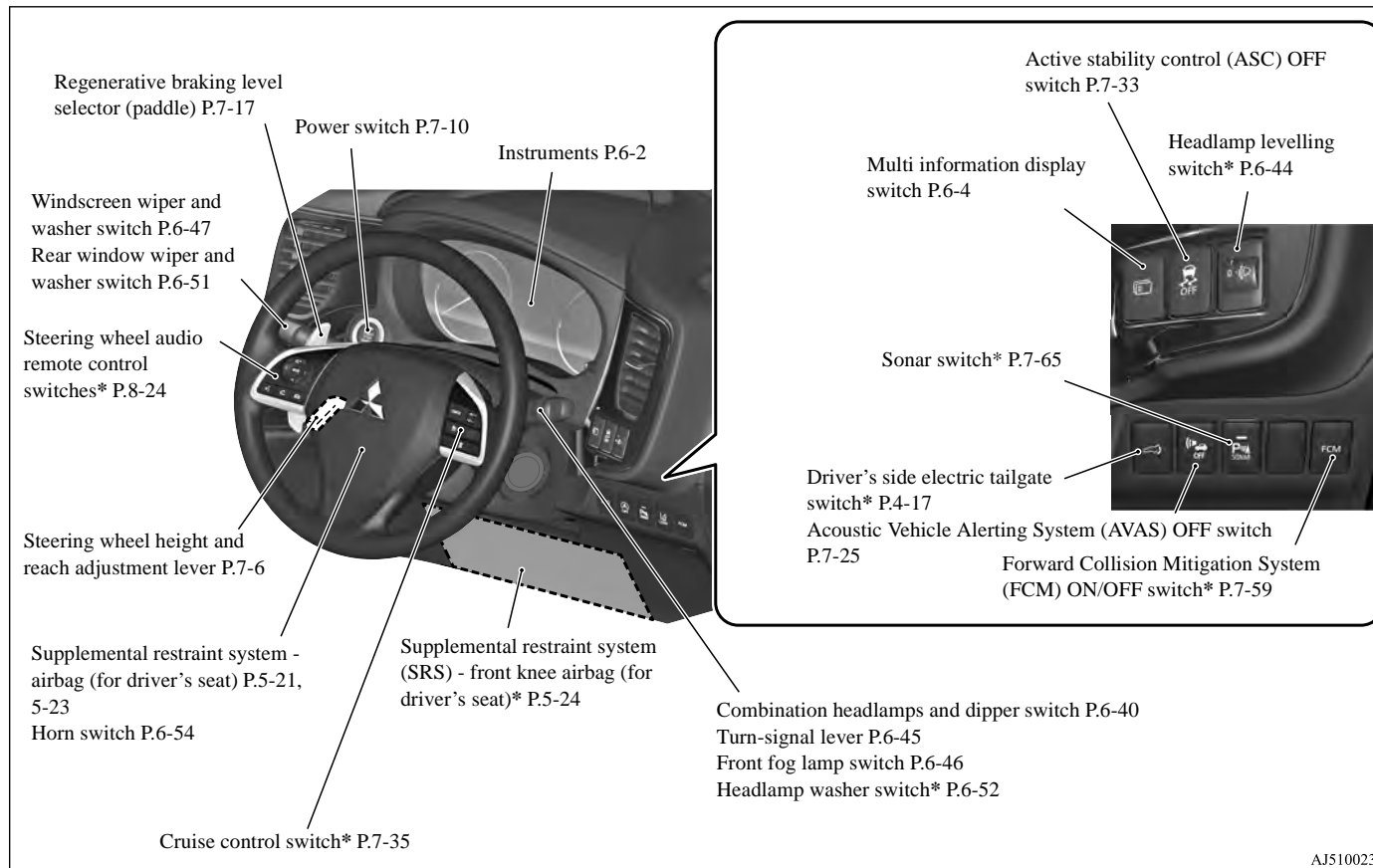

1-1 Overview

Instruments and Controls

1

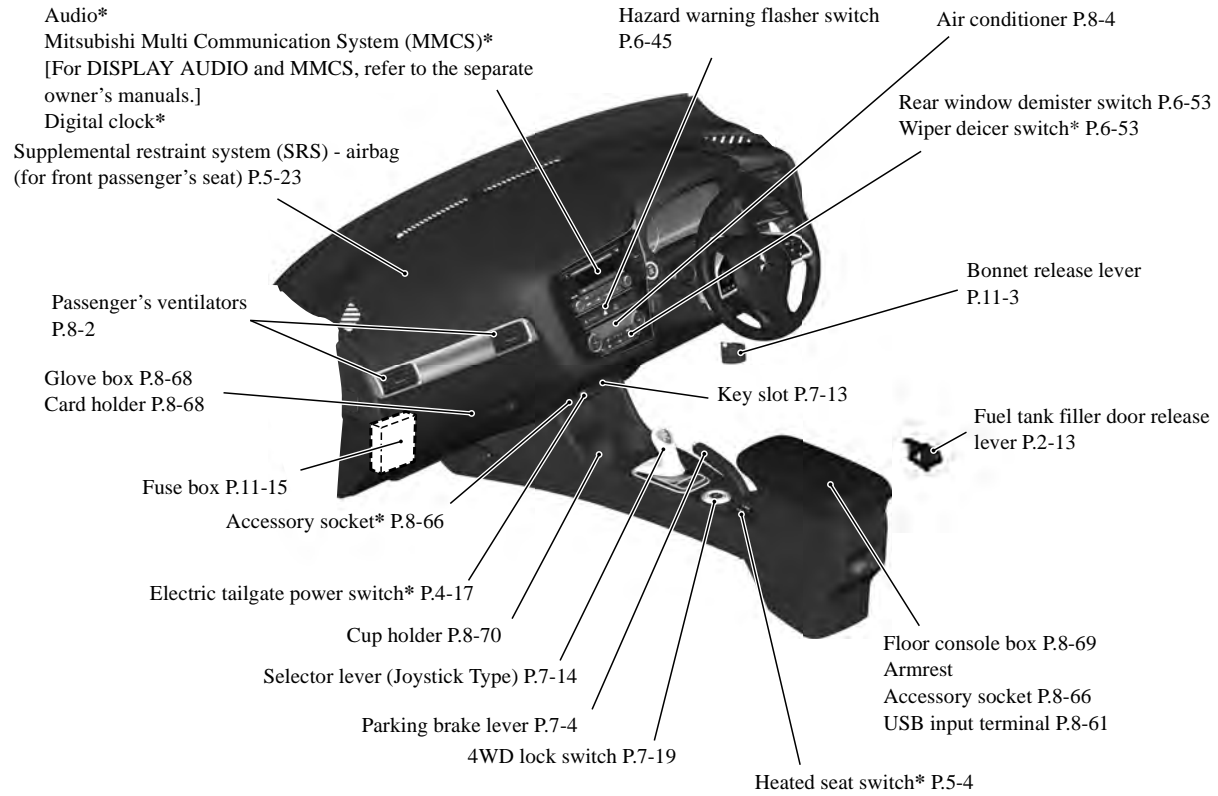

AJ5100245

Interior

1 Interior

E00100206107

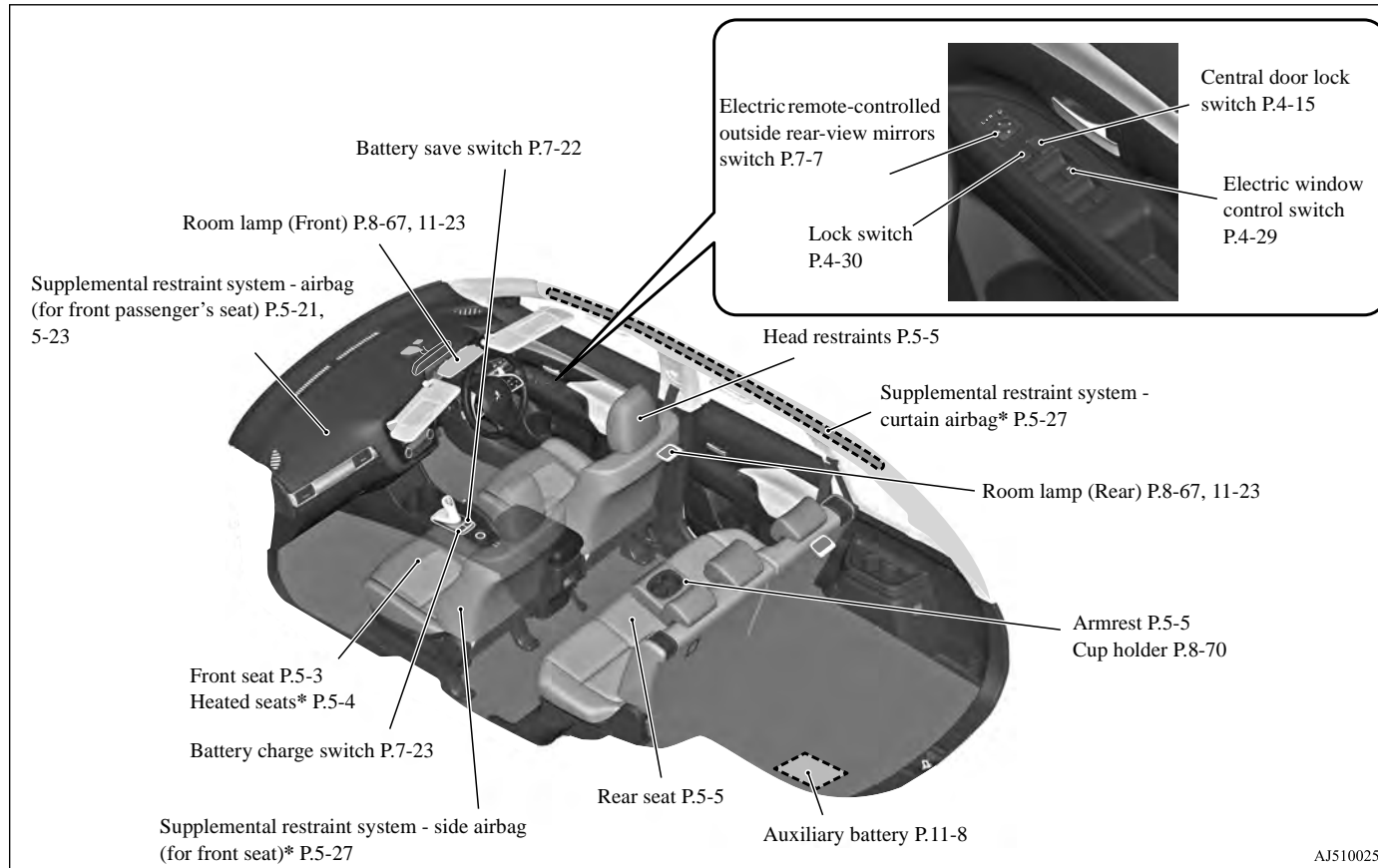

AJ5100258

1-3 Overview

Interior

1

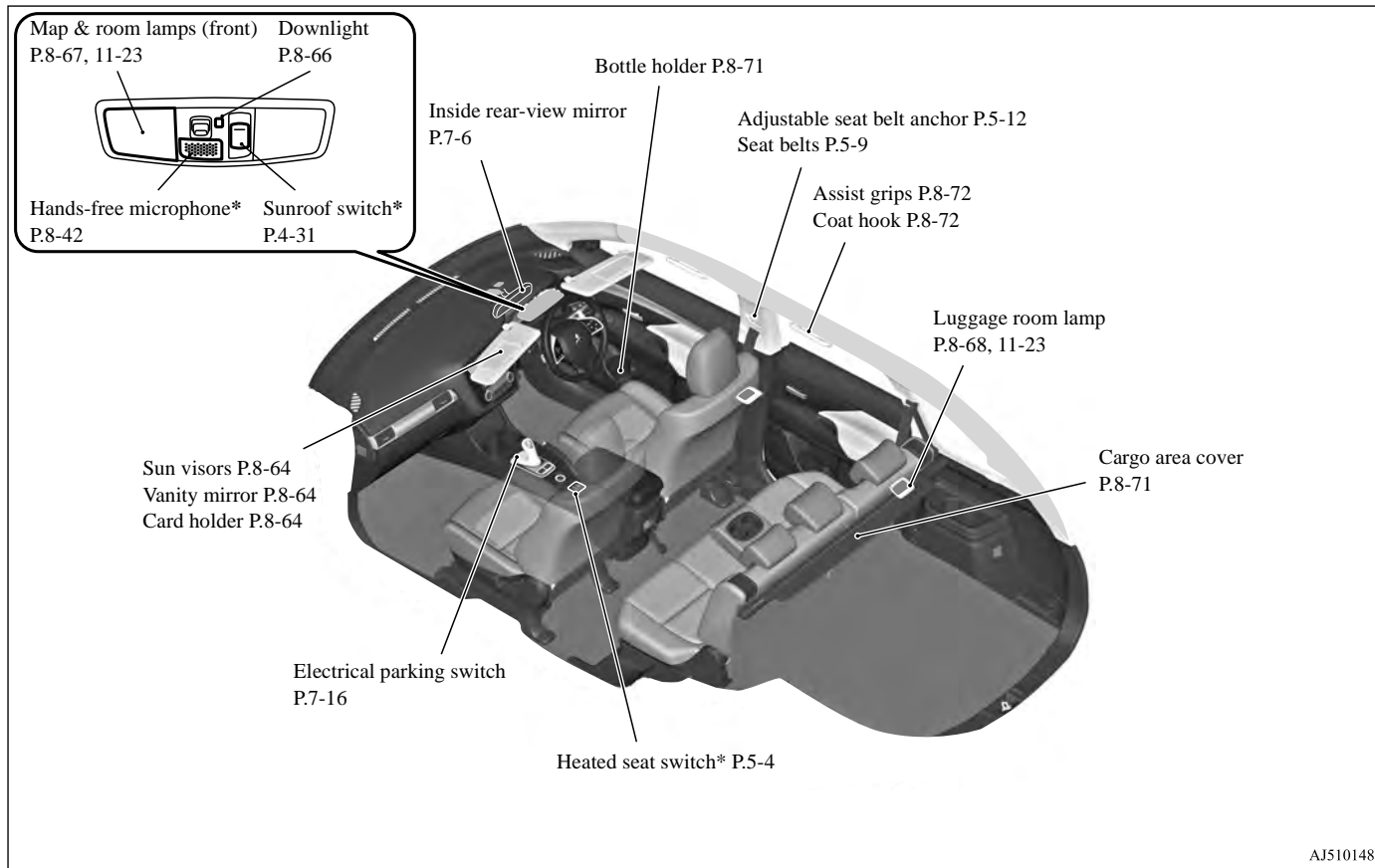

Overview 1-4



Luggage area

1 Luggage area

E00100402794

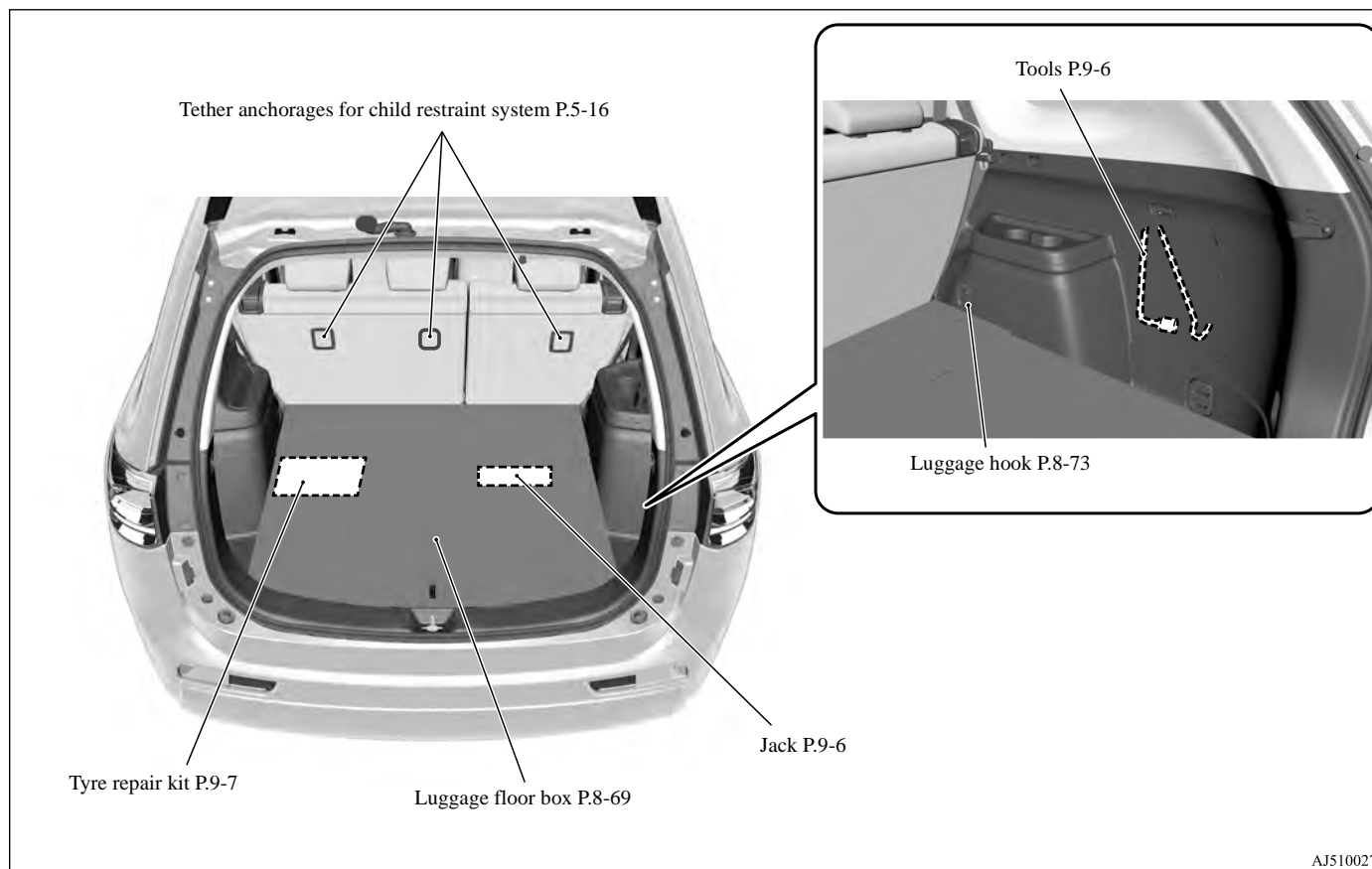

AJ5100274

1-5 Overview

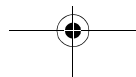

Outside (Front)

1

E00100506751

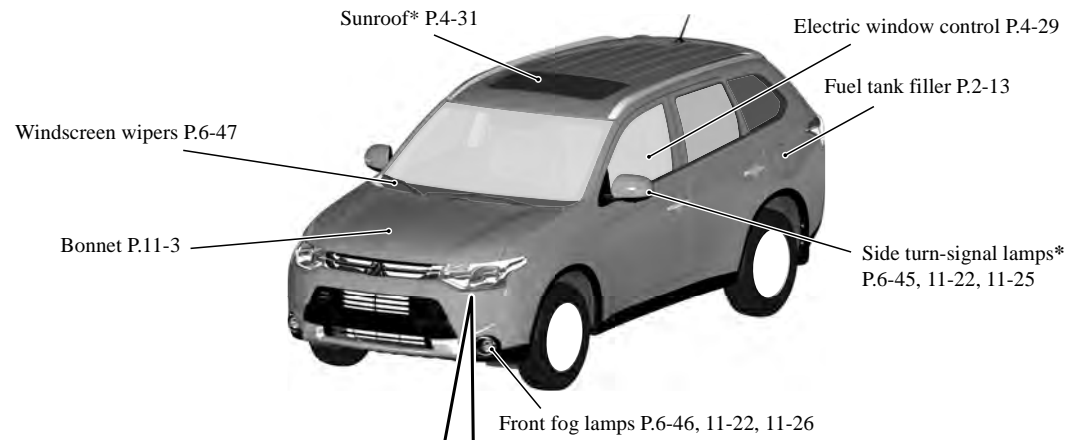

Except for high intensity discharge headlamp type

Front turn-signal lamps P.6-45, 11-22, 11-25

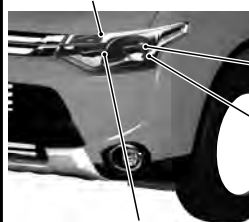

Headlamps, low beam P.6-42,
11-22, 11-23

Position lamps P.6-40, 11-22, 11-24

Headlamps, high beam
P.6-42, 11-22, 11-24

High intensity discharge headlamps type

Front turn-signal lamps P.6-45, 11-22, 11-25

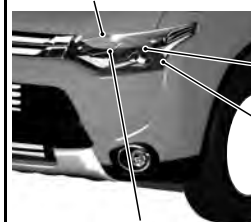

Headlamps, low beam P.6-42,
11-22, 11-23

Position lamps P.6-40, 11-22, 11-24

Headlamps, high beam
P.6-42, 11-22, 11-24

AJ5101499

Outside (Rear)

1 Outside (Rear)

E00100506764

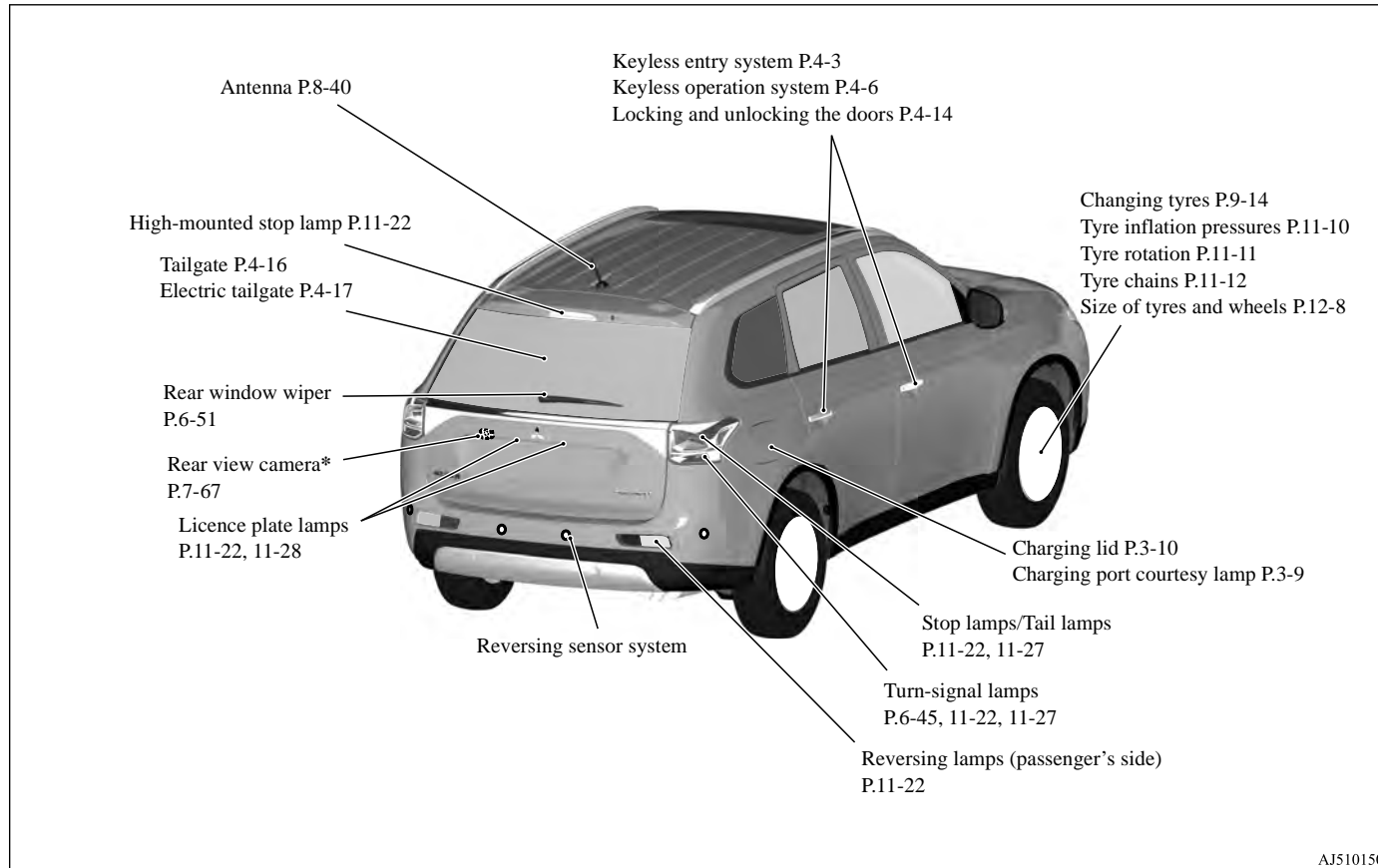

1-7 Overview

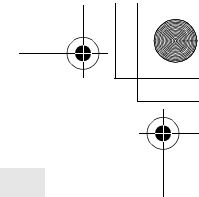
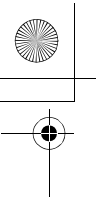

General information

2

Plug-in Hybrid EV System	2-2
Cautions and actions to deal with intense heat	2-8
Cautions and actions to deal with intense cold	2-9
Fuel selection	2-12
Filling the fuel tank.....	2-13
Installation of accessories	2-14
Modification/alterations to the electrical or fuel systems.....	2-15
Genuine Parts.....	2-15
Safety and disposal information for used engine oil	2-15
Do not carry fuel-filled containers or spray cans inside your vehicle	2-16
Taking your vehicle overseas.....	2-16

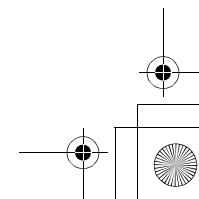
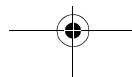
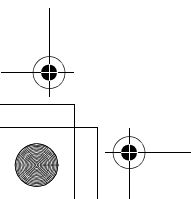
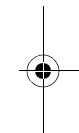
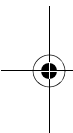

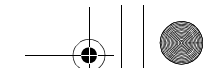

Plug-in Hybrid EV System

2

Plug-in Hybrid EV System

E00203500025

Main features

E00203600026

It is operated as electric vehicle in the EV drive mode using the electrical power stored in the drive battery,*¹ according to the remaining amount of the drive battery. It is also automatic control*² for driving in series hybrid mode or parallel hybrid mode using engine power from EV drive mode according to the driving condition or if the charging level of the drive battery is decreased.

*1.If there is a remaining amount in the drive battery, it is actively driven in the EV drive mode. The cruising range varies depending on the remaining charge in the drive battery, vehicle speed, and air conditioner operating conditions.

*2.You can adjust the timing to switch to the EV drive mode by using the battery save switch. Refer to “Battery save switch” on page 7-22.

- With the high performance motor, noise and vibration during driving are greatly limited and powerful acceleration can also be obtained.
- With the regenerative brake, the drive battery is automatically charged when the accelerator is released.
- The vehicle can be charged from EV charge power outlets (rated AC 240 V).

EV drive mode

- The vehicle is driven by the motors only using electrical power stored in the drive battery. However, EV drive mode is cancelled depending on the drive battery level, vehicle speed, and air conditioner operating conditions. Pay attention to the following points:
 - Check the EV cruising range in the information screen. Refer to “EV cruising range display/Total cruising range display” on page 6-13.
 - Drive your vehicle at moderate speeds avoiding quick acceleration/deceleration. Repeated quick acceleration/deceleration causes the drive battery level to decrease quickly, which extremely reduces the EV cruising range.

Series hybrid mode

- The vehicle is driven by the motors only using the electricity generated by the engine. This mode is used when the drive battery level is low, at quick acceleration, or when power is required like climbing uphill.

Parallel hybrid mode

- The vehicle is driven by the power of the engine, assisted by motors. This mode is used during high-speed driving with better engine efficiency.

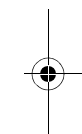
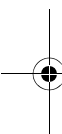

2-2 General information

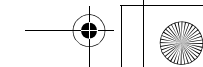
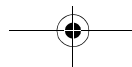

The roles of the motors and engine in each drive mode

2

	Motor	Engine	Driving conditions
EV Drive Mode	ON	OFF	Driving on streets and commuting
Series Hybrid Mode	ON	Generates electricity	Powerful acceleration uphill road such as mountain road
Parallel Hybrid Mode	ON	Drives front wheels and generates electricity	High-speed driving

Regenerative braking

Motion energy is converted into electric energy using the motor as a power generator. Then a braking force generates and converted electric energy will be charged to the drive battery.

- If you lift your foot off the accelerator pedal during driving, a braking force that equivalent to engine braking of a combustion engine vehicle will be generated. Also, if you shift the select position into “B” (BRAKE) from “D” (DRIVE), effectiveness of the regenerative braking is getting strong. Shift the selector lever into “B” (BRAKE) position according to the driving condition.
- Regenerative brake force increases with the foot brake force when the brake pedal is depressed.
- If a problem occurs in the Plug-in hybrid EV system, or if the ABS and/or the ASC have been activated, the regenerative braking will be restricted. The foot brake will still operate.

Operation of gasoline engine

E00203700027

- Even when the vehicle is driving in EV drive mode, it may be automatically changed to series hybrid mode or parallel hybrid mode in the following cases:
 - The plug-in hybrid EV system is too hot or too cold.
- Quick acceleration is applied.
- The air conditioner is operating.
- The accelerator pedal is depressed hard on an uphill road or expressway.
- In cold weather
- The vehicle has not been refueled for a long time.
- The drive battery level is low.

In addition to the above, there are more cases where EV drive mode is automatically changed to series or parallel hybrid mode.

- Even while the vehicle is stopped, the engine may automatically be started in the following cases:
 - The drive battery level is low.

Plug-in Hybrid EV System

2

- The plug-in hybrid EV system is too hot or too cold.
- The air conditioner is used.
- The vehicle has not been used for a long time.
- The engine has not been operated for a long time.

Refueling (gasoline)

E00203800028

- If the warning display appears, refuel as soon as possible.
If the vehicle runs out of fuel, the engine will not start even in a situation need to be generated electricity, the following conditions will occur.
- The driving performance falls (since only the electrical power stored in the drive battery can be used for the driving).
- The heating performance cannot be available (except vehicles with electric heater).
- The effectiveness of the heater is insufficient (vehicles with electric heater).
- The catalytic converter may be damaged due to excessive high temperature.

Refer to “Filling the fuel tank” on page 2-13.
Refer to “Fuel remaining display screen” on page 6-9.

2-4 General information

CAUTION

- Depending on the operating conditions of your vehicle, the fuel in the fuel tank may not be used for a long time and stay in the tank, resulting in deterioration of the fuel quality. As this may affect the engine and fuel system parts, observe the following instructions:
 - Run the engine by pressing the battery charge switch at least once in 3 months. Refer to “Battery charge switch” on page 7-23.
 - Refuel 20 litres or more of fuel every 6 months (to make the total refueling amount in 6 months be 20 litres or more).
 - If refueling of the above amount is not possible due to a high fuel level because the vehicle has not been used for a long time or for some other reason, consult a MITSUBISHI MOTORS Authorised Service Point.

Drive battery

E00203900029

WARNING

- **A sealed lithium ion high voltage battery (drive battery) is adopted for Outlander PHEV. If the drive battery is disposed of improperly, there is a risk of severe burns and electrical shock that may result in serious injury or death and there is also a risk of environmental damage.**

WARNING

- **Never attempt to use the drive battery for any other purpose.**
- It is the battery to operate the motor and the air conditioning.
In addition to the drive battery, Outlander PHEV has the auxiliary battery to operate lamps, wipers, etc.
- Compact, light-weight lithium ion battery with high energy density is used for the drive battery.
- The drive battery has the following characteristics.
Please read this carefully paying attention to the following:

Characteristics

- The same as ordinary lithium-ion batteries, the battery capacity of the drive battery gradually reduces with time, resulting in reduced cruising range. Depending on the usage conditions, such as frequent quick acceleration/deceleration, extremely hot weather, storing the vehicle in high ambient temperatures, etc., the rate of battery capacity drop will increase.

- The performance may be changed due to the outside temperature.
At low temperature, in particular, the EV cruising range is short and the charging time is long, compared to operation at normal temperature.
- The battery is gradually discharged without use and the battery charge is lowered.
- It is not necessary to consume the battery completely before charging.

Precautions for operation

- If your vehicle is not used for a long time, check the drive battery level display every 3 months.
If the drive battery level display shows 0, charge the battery until some indication appears. Alternately, put the operation mode of the power switch in “ON” to start the engine automatically, wait for the engine to stop automatically, then put the operation mode of the power switch in “OFF”.
- Mitsubishi Motors collects drive batteries. If you scrap your vehicle, please consult a Mitsubishi Motors Authorised Service Point.

EV cruising range

E00204000027

- Even if the charge level is the same, the EV cruising range may vary depending on driving conditions. Since driving at high speed or climbing on a hill requires higher consumption of the drive battery than usual, the EV cruising range is shortened.
- Since the air conditioning (cooling or heating) consumes power of the drive battery, its operation results in a shorter EV cruising range. Maintain an appropriate temperature.
- Put the selector lever to “B” (BRAKE) position according to the road condition. To charge the drive battery with appropriate use of the regenerative brake, it can be increased the EV cruising range.

Acoustic Vehicle Alerting System (AVAS)

E00204100028

The Acoustic Vehicle Alerting System (AVAS) is device that uses sound to alert pedestrians of the presence of the vehicle. The system operates when the vehicle speed is about 35 km/h or less and the engine is not running.

Refer to “Acoustic Vehicle Alerting System (AVAS)” on page 7-24.

⚠ WARNING

- **Even if the Acoustic Vehicle Alerting System (AVAS) sounds, pay special attention to pedestrians.**
Pedestrians may not notice the oncoming vehicle, which may cause an accident resulting in serious personal injury or death.

In case of a collision

E00204200029

A crash or impact significant enough to require an emergency response for conventional vehicles would also require the same response for Outlander PHEV.

Also follow the instructions described below to avoid severe burns and electrical shock that may result in serious injury or death.

⚠ WARNING

- **If your vehicle is drivable, pull your vehicle off the road to a safe, nearby location and remain on the scene.**
Also, if possible, do the following operations and stay out of the way of any oncoming traffic while awaiting the arrival of emergency responders.
 - Apply chocks to the wheels.
 - Put the select position in “P”(PARK) position.
 - Apply the parking brake.

Plug-in Hybrid EV System

2

⚠ WARNING

- Open the windows, doors and tailgate.
- Put the operation mode in OFF.
- Turn on the hazard warning flashers.
- Move the key away from the vehicle to prevent unintended start-up of the system by inadvertent contact with a switch or impact from the crash.
- Never touch high-voltage wiring, connectors, and other high-voltage parts, such as the inverter unit and drive battery. An electric shock may occur if exposed electric wires are visible when viewed from inside or outside of your vehicle. For their locations, see “High-voltage components” on page 2-7.
- If the vehicle receives a strong impact to the floor while driving, stop the vehicle in a safe place and check the floor.
- Never start the plug-in hybrid EV system if you found the leak of a liquid (except water of the air conditioner) while checking the outside of the vehicle because there is possibility the fuel system has been damaged and causing of fire or exploding. In such case, immediately contact your MITSUBISHI MOTORS Authorized Service Point.

⚠ WARNING

- Leaks or damage to the drive battery may result in a fire. If you discover them, contact emergency services immediately. Since the fluid leak may be lithium manganese from the Lithium-ion battery, never touch any fluid leaking from the inside or outside of the vehicle. If the fluid contacts your skin or eyes, wash it off immediately with a large amount of water and receive immediate medical attention to help avoid serious injury.
- If you are unable to safely assess the vehicle due to vehicle damage, do not touch the vehicle. Leave the vehicle and contact emergency services. Advise emergency responders that this is a Plug-in Hybrid vehicle.
- If a fire occurs in this vehicle, leave the vehicle as soon as possible and contact emergency services. Do not attempt to extinguish a fire by yourself. If the fire involves a lithium-ion battery, it will require large, sustained volumes of water for extinguishment. Using a small amount of water or the incorrect fire extinguisher can result in serious injury or death from electrical shock.
- When you leave the vehicle, if possible, open the windows, doors and tailgate to prevent accumulation of poisonous/combustible gasses. This will also assist in the rescue and fire fighting process.

⚠ WARNING

- As with any vehicle fire, the byproducts of combustion can be toxic. Do not inhale smoke, vapors, or gas from the vehicle. Move to a safe distance upwind and uphill from the vehicle fire and out of the way of any oncoming traffic while awaiting the arrival of emergency responders.
- If you detect leaking fluids, sparks, smoke, flames, gurgling, popping or hissing noises originating from the high voltage battery compartment, contact emergency services immediately. This may result in a fire.
- Physical damage to the vehicle or high voltage battery may result in immediate or delayed release of toxic and/or flammable gases and fire.
- If your vehicle needs to be towed, transport the vehicle on a flatbed truck or tow the vehicle with all wheels off the ground. If the any wheels are on the ground when towing, this may cause damage to the electric motors. This may also cause a fire, if wiring in the electric motor unit room becomes damaged. Refer to “Towing” on page 9-19.
- Do not attempt to repair a damaged Plug-in Hybrid vehicle by yourself. Please contact a MITSUBISHI MOTORS Authorized Service Point for service.

⚠ WARNING

- In the event of an accident that requires body repair and painting, the vehicle should be delivered to a MITSUBISHI MOTORS Authorised Service Point to have the drive battery and high voltage parts such as the inverter, including the attached wiring harness, removed prior to painting. If exposed to heat in the paint booth, the drive battery will experience battery capacity loss. A damaged drive battery can also pose safety risks to untrained mechanics and repair personnel.

📖 NOTE

- The emergency shut-off system will be activated and the high-voltage system will automatically turn off under the following conditions:
 - Certain front, side or rear collisions.
 - Certain Plug-in Hybrid EV system malfunctions.
- When the emergency shut-off system is activated, the ready indicator is turned off. Refer to “Indicator and warning lamps” on page 6-21.
- If the emergency shut-off system activates, contact a MITSUBISHI MOTORS Authorised Service Point.

Inspection and maintenance

E00204300020

When performing inspection and maintenance, be careful in the following points.

⚠ WARNING

- Before performing inspection or maintenance, be sure to disconnect the charge connector from the vehicle and confirm that put the operation mode of the power switch in “OFF”.
- Never touch, disassemble, remove or replace highvoltage parts, exposed electrical components, cables or connectors. Failure to follow this instruction can result in severe burns or electric shock causing serious injury or death. High-voltage cables are colored orange. The vehicle high voltage system has no user serviceable parts. Take your vehicle to a MITSUBISHI MOTORS Authorised Service Point for any necessary maintenance.
- Never touch the service plug under the rear seat. Improper handling of this could cause an electric shock which result in a serious injury or death. The service plug is used to shut off the high voltage from the drive battery when repairing the vehicle at a MITSUBISHI MOTORS Authorised Service Point.

High-Voltage components

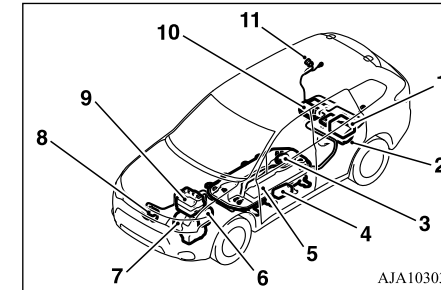

- 1- On board charger/DC-DC converter
- 2- Rear motor
- 3- Service plug
- 4- Electric heater*
- 5- Drive Battery
- 6- Front motor
- 7- Generator
- 8- Air conditioner compressor
- 9- Power drive unit (PDU)
- 10- Rear electric motor control unit (MCU)
- 11- Charge port

Cautions and actions to deal with intense heat

2

WARNING

- The Plug-in Hybrid EV System uses high voltage up to DC 300 volt. The system can be hot during and after starting and when the vehicle is shut off. Be careful of both the high voltage and the high temperature. Follow the warning labels that are attached to the vehicle.
- Always assume the high voltage battery and associated components are energized and fully charged.
- Never perform servicing when READY indicator is illuminating or when the charging indicator is illuminating or flashing because the high-voltage system is operating.

For persons with electro-medical apparatus such as implantable cardiac pacemaker or implantable cardioverter-defibrillator

E00204400021

WARNING

- Do not bring your body close to the foot area of the rear seat and do not stay in the luggage compartment while the vehicle is moving. Also, do not allow persons using an electro-medical apparatus to stay in the luggage compartment while the vehicle is moving. The operation of electro-medical apparatus may be affected.
- Before you perform charging work, ask the manufacturer of your electro-medical apparatus about the effect from charging work. Charging may affect the operation of your electro-medical apparatus. Refer to “Normal charging (charging method with rated AC 240 V outlet)” on page 3-8.

WARNING

- Observe the following precautions for normal charging:
 - Keep away from the charge connector or control box.
 - Do not stay inside of the vehicle.
 - Do not get in the vehicle (including the luggage compartment) to take out something or for other purpose.Refer to “Normal charging (charging method with rated AC 240 V outlet)” on page 3-8.

Cautions and actions to deal with intense heat

E00203001069

- When the ambient temperature is approximately 45 °C or higher, the phenomena described below may occur. Please take the described action.

Cautions and actions to deal with intense cold

- Even if the ambient temperature is approximately 45 °C or lower, when driving at high-speed and uphill repeatedly, the phenomena described below may occur. Please take the described actions.

2

Approx. ambient temperature	Phenomena		Corrective action
Approx. 45 °C or higher	Startup and driving	<ul style="list-style-type: none"> • The motor output is restricted and the vehicle performance may be decreased. Then, the limited driving mode warning display* may be displayed. 	<ul style="list-style-type: none"> • Stop the vehicle at a safe place if needed with the plug-in hybrid EV system started.
	Charging and battery	<ul style="list-style-type: none"> • Charging time becomes longer, charging may not be possible or it may stop on the way. 	<ul style="list-style-type: none"> • Park in a well-ventilated, shady place.

NOTE

- *: Refer to “Limited driving mode warning display” on page 6-33. Display of the limited driving mode warning display does not indicate a malfunction.

Cautions and actions to deal with intense cold

E00203101073

- When the ambient temperature is approximately -15 °C or lower, the phenomena described below may occur. Please take the described corrective action.

Cautions and actions to deal with intense cold

2

Approx. ambient temperature	Phenomena		Corrective action
Approx. -15 °C or lower	Startup and driving	<ul style="list-style-type: none"> The motor output is restricted and the vehicle performance may be decreased. Then, the limited driving mode warning display*¹ may be displayed. 	<ul style="list-style-type: none"> Keep driving if you can drive at a similar speed as surrounding vehicles. If you cannot drive at a similar speed as surrounding vehicles, stop the vehicle at a safe place and charge the drive battery.
		<ul style="list-style-type: none"> Regenerative braking performance may decrease. 	<ul style="list-style-type: none"> When braking, depress the brake pedal harder.
	Charging and battery	<ul style="list-style-type: none"> Charging time becomes longer. Complete charging may not be possible. 	<ul style="list-style-type: none"> When you have finished driving, charge the drive battery before its temperature falls.

Cautions and actions to deal with intense cold

2

Approx. ambient temperature	Phenomena		Corrective action
Approx. -30 °C or lower	Startup and driving	<ul style="list-style-type: none"> The Plug-in Hybrid EV system may not be started. Then, blinking of the ready indicator*² may continue and “BATTERY TOO COLD” may be displayed on the multi information display. 	<ul style="list-style-type: none"> In the daytime, wait for the temperature to rise, restart the plug-in hybrid EV system. On vehicles equipped with both MITSUBISHI Remote control and electric heater, if low temperature is predicted, even if the drive battery is full charge, connect EV charging cable beforehand. The drive battery is automatically warmed up*³.
		<ul style="list-style-type: none"> The vehicle performance may be restricted and the normal driving may become impossible. Then, “BATTERY TOO COLD” may be displayed. 	<ul style="list-style-type: none"> Stop the vehicle at a safe place immediately.
		<ul style="list-style-type: none"> Regenerative braking performance may decrease or lose. 	<ul style="list-style-type: none"> When braking, depress the brake pedal harder.
	Charging and battery	<ul style="list-style-type: none"> Charging may become impossible or it may stop on the way. 	<ul style="list-style-type: none"> In the daytime, wait for the temperature to rise, restart the plug-in hybrid EV system.

CAUTION

- “BATTERY TOO COLD” is displayed, contact a MITSUBISHI MOTORS Authorized Service Point.
- Blinking of the ready indicator*² continues and “BATTERY TOO COLD” is displayed on the multi information display with vehicle conditions, the drive battery can not be warm up.

Fuel selection

2

NOTE

- *1: Refer to “Limited driving mode warning display” on page 6-33.
Display of the Limited driving mode warning display does not indicate a malfunction.
- *2: Refer to “ready indicator” on page 6-37.
- *3: To make warm up the drive battery, you should perform to communicate with the wireless LAN device (which conforms to IEEE 802.11 b and supports iOS or Android) for MITSUBISHI Remote Control to the vehicle. If the information of “” mark on the wireless LAN device is displayed, connect the EV charging cable as soon as possible.
Refer to “MITSUBISHI Remote Control” on page 3-17.
If the warming up of the drive battery is activated during home or public charging device (EVSE: Electric Vehicles Supply Equipment) charging, the charging and warming up of the drive battery may be stopped.
While warm up the drive battery, the following phenomena may occur.
 - The operation sound of on board equipment and the state of charge is displayed on the multi information display.
Refer to “Charging from rated AC 240V outlet” on page 3-10.
 - Inside of the vehicle may be heated automatically.
 - The drive battery may not become full charge, or the remaining capacity of drive battery may decrease.

Fuel selection

E00200104259

Recom- mended fuel	Unleaded petrol octane number 90 RON or higher
--------------------------	---

CAUTION

- Your vehicle has a fuel filler tube specially designed to accept the smaller diameter unleaded fuel dispensing nozzles only.

Liquid Petroleum Gas (L.P.G.)

CAUTION

- Your vehicle cannot be run on L.P.G.
Use of an L.P.G. fuel conversion may result in significant damage to your vehicles fuel system, engine, engine sensors and exhaust system.

Ethanol

A mixture of up to 10 % ethanol (grain alcohol) and 90 % unleaded petrol may be used in

your vehicle, provided the octane number is at least as high as that recommended for unleaded petrol.

CAUTION

- Do not use more than 10 % concentration of ethanol (grain alcohol) by volume.
Use of more than 10 % concentration may lead to damage to your vehicle fuel system, engine, engine sensors and exhaust system.
- Do not operate your vehicle on gasoline containing methanol. Using this type of alcohol could adversely affect the vehicle’s performance and damage critical parts of the vehicle’s fuel system.

Filling the fuel tank

2

NOTE

- Poor quality petrol can cause problems such as hard starting, stalling, engine noise and hesitation. If your experience these problems, try another brand and/or grade of petrol.

If the check engine warning lamp flashes, have the system checked as soon as possible at a MITSUBISHI MOTORS Authorised Service Point.

Filling the fuel tank

E00200203572

WARNING

- When handling fuel, comply with the safety regulations displayed by garages and filling stations.
- Gasoline is highly flammable and explosive. You could be burned or seriously injured when handling it. When refueling your vehicle, always put the operation mode of the power switch in OFF and keep away from flames, sparks, and smoking materials. Always handle fuel in well-ventilated outdoor areas.
- Before removing the fuel cap, be sure to get rid of your body's static electricity by touching a metal part of the car or fuel pump. Any static electricity on your body could create a spark that ignites fuel vapor.

WARNING

- Perform the whole refueling process (opening the fuel tank filler door, removing the fuel cap, etc.) by yourself. Do not let any other person come near the fuel tank filler. If you allowed a person to help you and that person was carrying static electricity, fuel vapor could be ignited.
- Do not perform charging and refueling at the same time. If you charged with static electricity, fuel vapor could be ignited by the discharge spark.
- Do not move away from the fuel tank filler until refueling is finished. If you moved away and did something else (for example, sitting on a seat) part-way through the refueling process, you could pick up a fresh charge of static electricity.
- Be careful not to inhale fuel vapor. Fuel contains toxic substances.
- Keep the doors and windows closed while refueling the vehicle. If they were open, fuel vapor could get into the cabin.
- If the tank cap must be replaced, use only a MITSUBISHI MOTORS original part.

CAUTION

- Depending on the operating conditions of your vehicle, the fuel in the fuel tank may not be used for a long time and stay in the tank, resulting in deterioration of the fuel quality. As this may affect the engine and fuel system parts, observe the following instructions:
 - Run the engine by pressing the battery charge switch at least once in 3 months. Refer to "Battery charge switch" on page 7-23.
 - Refuel 20 litres or more of fuel every 6 months (to make the total refueling amount in 6 months be 20 litres or more).
- If refueling of the above amount is not possible due to a high fuel level because the vehicle has not been used for a long time or for some other reason, consult a MITSUBISHI MOTORS Authorised Service Point.

Fuel tank capacity

45 litres

Refuelling

1. Before filling with fuel, stop the plug-in hybrid EV system.

Installation of accessories

2

2. The fuel tank filler is located on the rear left side of your vehicle.

Open the fuel tank filler door with the release lever located the side of the driver's seat.

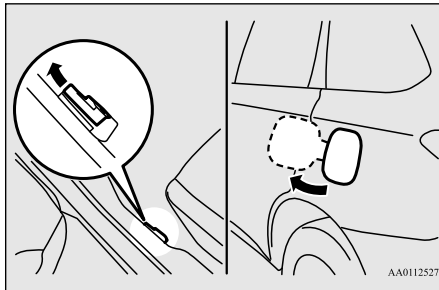

3. Open the fuel tank filler tube by slowly turning the cap anticlockwise.

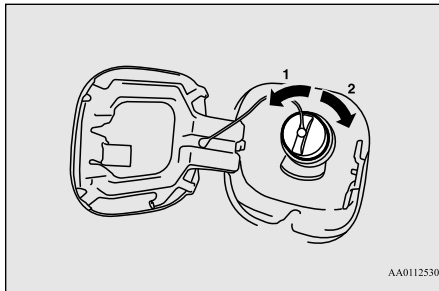

- 1- Remove
- 2- Close

CAUTION

- Since the fuel system may be under pressure, remove the fuel tank filler tube cap slowly. This relieves any pressure or vacuum that might have built up in the fuel tank. If you hear a hissing sound, wait until it stops before removing the cap. Otherwise, fuel may spray out, injuring you or others.

NOTE

- While filling with fuel, hang the fuel cap on the hook (A) located on the inside of the fuel tank filler door.

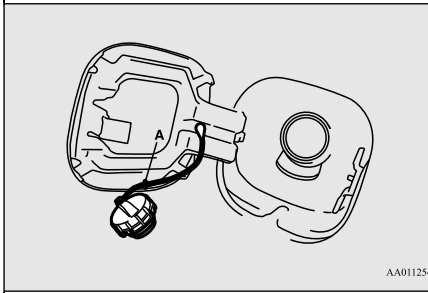

4. Insert the gun in the tank port as far as it goes.

CAUTION

- Do not tilt the gun.

5. When the gun stops automatically, do not fill with fuel any more.

6. To close, turn the fuel cap slowly clockwise until you hear clicking sounds, then gently push the fuel tank filler door closed.

Installation of accessories

E00200300963

We recommend you to consult your MITSUBISHI MOTORS Authorised Service Point.

- The installation of accessories, optional components, etc., should only be carried out within the limits prescribed by law in your country, and in accordance with the guidelines and warnings contained within the documents accompanying this vehicle.
- Installing electric components incorrectly could lead to a fire. See the "Modification/alterations to the electrical or fuel systems" section within this owner's manual.
- Using a cellular phone or radio set inside the vehicle without an external antenna may cause electrical system interference, which could lead to unsafe vehicle operation.

Modification/alterations to the electrical or fuel systems

- Tyres and wheels which do not meet specifications must not be used. Refer to the “Specifications” section for information regarding wheel and tyre sizes.

Important points!

Due to large number of accessory and replacement parts of different manufactures available in the market, it is not possible, not only for MITSUBISHI MOTORS, but also a MITSUBISHI MOTORS Authorised Service Point, to check whether the attachment or installation of such parts affects the overall safety of your MITSUBISHI-vehicle.

Even when such parts are officially authorised, for example by a “general operators permit” (an appraisal for the part) or through the execution of the part in an officially approved manner of construction, or when a single operation permit following the attachment or installation of such parts, it cannot be deduced from that alone, that the driving safety of your vehicles has not been affected.

Consider also that there basically exists no liability on the part of the appraiser or the official. Maximum safety can only be ensured with parts recommended, sold and fitted or installed by a MITSUBISHI MOTORS

authorised Service Point (MITSUBISHI MOTORS GENUINE replacement parts and MITSUBISHI MOTORS accessories). The same also pertains to modifications of MITSUBISHI vehicles with respect to the production specifications. For safety reasons, do not attempt any modifications other than those that follow the recommendations of a MITSUBISHI MOTORS authorised Service Point.

Modification/alterations to the electrical or fuel systems

E00200400368

MITSUBISHI MOTORS CORPORATION has always manufactured safe, high quality vehicles. In order to maintain this safety and quality, it is important that any accessory that is to be fitted, or any modifications carried out which involve the electrical or fuel systems, should be carried out in accordance with MITSUBISHI guidelines.

CAUTION

- If the wires interfere with the vehicle body or improper installation methods are used (protective fuses not included, etc.), electronic devices may be adversely affected, resulting in a fire or other accident.

Genuine Parts

E00200500499

2

MITSUBISHI MOTORS has gone to great lengths to bring you a superbly crafted automobile offering the highest quality and dependability.

Use MITSUBISHI MOTORS GENUINE Parts, designed and manufactured to maintain your MITSUBISHI MOTORS automobile at top performance. MITSUBISHI MOTORS GENUINE Parts are identified by this mark and are available at all MITSUBISHI MOTORS Authorised Service Points.

**MITSUBISHI MOTORS
GENUINE PARTS**

Safety and disposal information for used engine oil

E00200600155

WARNING

- Prolonged and repeated contact may cause serious skin disorders, including dermatitis and cancer.
- Avoid contact with the skin as far as possible and wash thoroughly after any contact.

Do not carry fuel-filled containers or spray cans inside your vehicle

2

WARNING

- Keep used engine oils out of reach of children.

Protect the environment

It is illegal to pollute drains, water courses and soil. Use authorised waste collection facilities, including civic amenity sites and garages providing facilities for disposal of used oil and used oil filters. If in doubt, contact your local authority for advice on disposal.

Do not carry fuel-filled containers or spray cans inside your vehicle

E00201000013

WARNING

- Leaving fuel-filled containers or spray cans in your vehicle could cause the containers to burst or an explosion of evaporated gas.

Taking your vehicle overseas

E00200800115

MITSUBISHI MOTORS from time to time receives enquiries regarding shipping of vehicles overseas.

The enquiries mainly fall into the following categories:

- Private individuals wishing to take their locally purchased vehicle overseas.
- Private individuals wishing to purchase an export specification (e.g. left hand drive) vehicle here in Australia and take it overseas.
- Commercial enquiries wishing to arrange the export of MITSUBISHI MOTORS vehicles to an associated or client company.

MITSUBISHI MOTORS advises the following:

Different countries have different vehicle regulations, fuel standards, driving conditions and customer preferences.

A vehicle sold in several markets may look outwardly similar but have very significant differences.

Taking a vehicle built to an Australian specification overseas therefore runs the risk of:

- Non-compliance with local regulations.
- Unsatisfactory vehicle performance.
- Difficulties in after sales service.
- Parts unavailable.
- Diminished resale value.

We believe the practice to be uneconomic and strongly recommend against it.

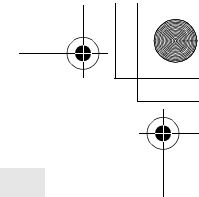
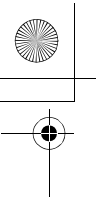

Charging

Charging	3-2
Battery	3-3
Basic knowledge for charging	3-3
EV charging cable	3-5
Normal charging (charging method with rated AC 240 V outlet) ...	3-8
Charging troubleshooting guide	3-15
MITSUBISHI Remote Control*	3-17

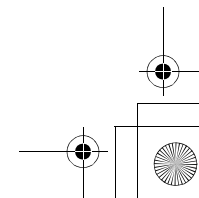
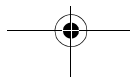
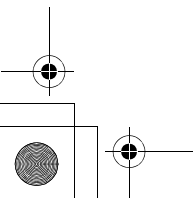
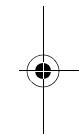
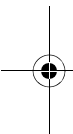

Charging

Charging

E08303801051

3

Your vehicle is equipped with a charge port and a charging cable (EV charging cable) for charging with a AC 240V outlet. You can also charge your vehicle using 240V home or public charging device (EVSE*¹) compatible with Outlander PHEV.

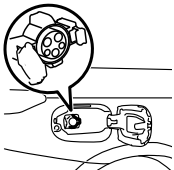
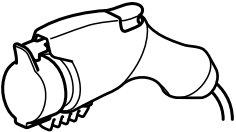
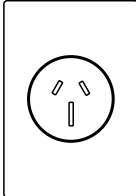
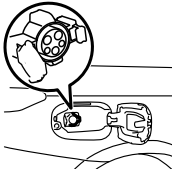
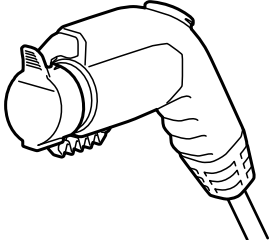
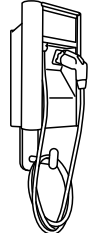
Category	Charge port	Charge connector	Charging Source	Charging time with fully discharged battery	Reference
Normal charging (AC 240V) When using a genuine charging cable	 Right rear side of vehicle		 240V household outlet (15 amp dedicated circuit required)	About 5 hours	P.3-8
Normal charging (AC 240V) When using a home or public charging device (EVSE* ¹)	 Right rear side of vehicle		 Home or public charging device	240V/15A: About 3.5 hours* ²	P.3-8

*¹: EVSE = Electric Vehicle Supply Equipment

*2: Use this time as a guide because the rated AC voltage and the rated current value may differ from country to country. Alternately, the drive battery can be almost fully charged by turning on the battery charge switch while the vehicle is running or stopping. Refer to "Battery charge switch" on pages 7-23.

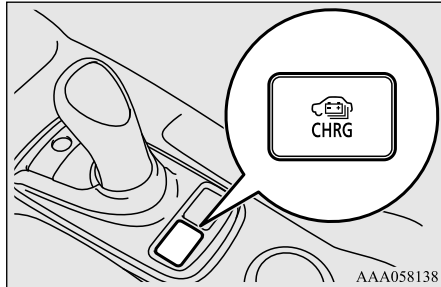

3

Battery

E08300101037

There are two types of batteries installed in your vehicle: a drive battery for operating the motor (electric motor unit) and air conditioning as well as an auxiliary battery for starting the Plug-in Hybrid EV system and operating the lamps, wipers, etc.

This chapter explains charging of the drive battery.

NOTE

- The auxiliary battery is automatically charged while the ready indicator is illuminated or during charge for the drive battery. Refer to "Ready indicator" on page 6-37.

NOTE

- If the auxiliary battery is flat, the Plug-in Hybrid EV system cannot be started. Refer to "Emergency starting" on page 9-2.

Basic knowledge for charging

E08300201070

Normal charging is performed through the on board charger using rated AC 240 V outlet as the power source

WARNING

- To reduce the risk of electric shock or fire due to electric leak, always use an outlet protected by a residual current detector, rated for amperage equal to or greater than the value specified by MITSUBISHI MOTORS, and that is connected to a dedicated branch circuit. If the circuit is shared, and another electrical device is being used at the same time the vehicle is charging, the breaker may trip and the circuit may cause adverse interference on MCB (Moulded Circuit Board) and household electrical appliances such as TVs and audio systems.
- It is possible to charge even in rain or snow. However, be sure to pay attention to the following:

Basic knowledge for charging

3

WARNING

- Do not touch normal charging port, normal charge connector, outlet and plug with wet hands.
- Keep away from water when connecting the normal charging port, normal charge connector, outlet and plug.
- Do not perform the charging in the out of doors when heavy rain, heavy snow, strong winds, and thunder, when a bad weather is expected in the future.
- If water goes into the normal charging port or the normal charge connector, it could cause a short circuit, a fire and an electric shock.
Be sure closing completely the charging lid and the inner lid and do not leave the EV charging cable in an outdoors.
- If the connected part of the charging plug has been buried in snow while charging, turn off the hand switch or the breaker connected with the outlet first, then remove the snow and disconnect the charging plug. If your vehicle body has been buried in snow while charging, remove the snow and then disconnect the charge connector.

WARNING

- When you perform the normal charging at away from home, some normal chargers may not correspond to your vehicle. Consult an administrator or a maker of the normal charger that it corresponds to your vehicle before using it. Also perform normal charging according to the operating procedure indicated on the body of normal charger.

CAUTION

- Do not attempt to perform a jump start on the auxiliary battery at the same time that the drive battery is being charged. Doing so may damage the vehicle or charging cable and could cause an injury.
Refer to “Emergency starting” on page 9-2.

NOTE

- To maintain the capacity of the drive battery, the following is recommended:
 - Fully charge the vehicle in normal charging every two weeks.
 - Do not repeat charging near the full charge level.

NOTE

- If your vehicle is not used for a long time, check the energy level gauge every 3 months. If the gauge shows 0, charge the drive battery until some indication appears. Alternately, put the operation mode of the power switch in “ON” to start the engine automatically, wait for the engine to stop automatically, then put the operation mode of the power switch in “OFF”.
- In the event of a electrical power outage while charging, charging restarts automatically with the restoration of electricity.

EV charging cable

E08301101092

Your vehicle is equipped with an EV charging cable that consists of a cable (A), control box (B), EV charging cable plug (C), and normal charge connector (D).

3

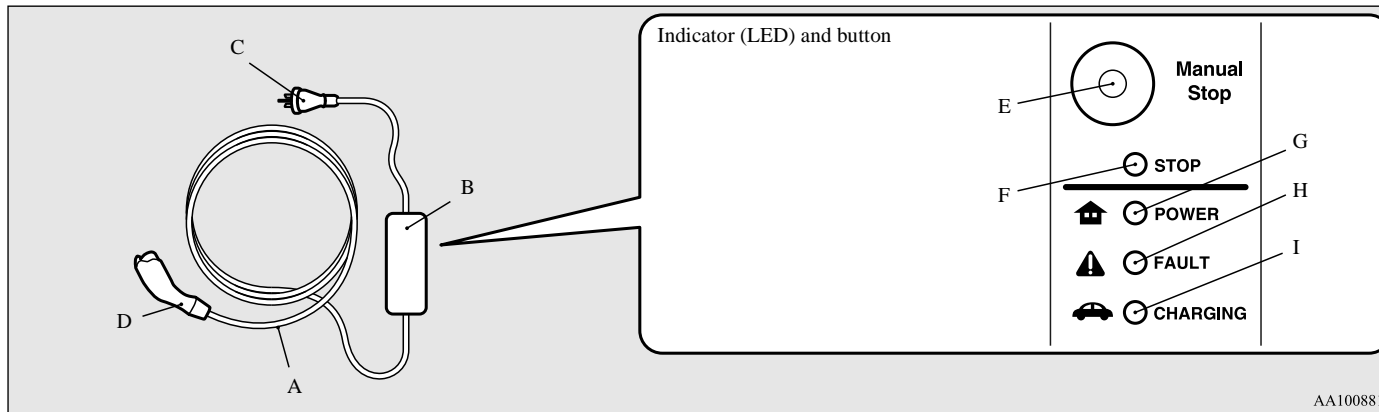

AA1008812

E- Manual stop button
F- Stop indicator

G (🏠)- POWER indicator
H (⚠️)- FAULT indicator
I (🚗)- CHARGING indicator

To stop charging, simply press manual stop button (E) and stop indicator (F) is illuminated. Re-connect the EV charging cable plug (C) to charge again.

POWER (G), FAULT (H) and CHARGING (I) indicators located on the control box will illuminate/blink in response to the following conditions:

EV charging cable

○: Illuminates ◎: Blinking ●: Not illuminates

3

POWER ⏻	FAULT ⚠	CHARGING 🔌	Operating condition
○	○	○	Every time the charging cable plug (C) is connected to an outlet, all indicator lamps illuminate for 0.5 seconds.
○	●	●	After initial processing is completed, when the normal charge connector is not connected to the charge port, or the normal charge connector is connected to the charge port but charging is not being performed.
○	●	○	While the drive battery is being charged.
○	●	◎	When charging is completed.

POWER ⏻	FAULT ⚠	CHARGING 🔌	Abnormal operating condition and corrective action
○	◎	●	When an electric leakage occurs or the EV charging cable malfunctions Stop using the EV charging cable immediately and contact a MITSUBISHI MOTORS Authorised Service Point.
○	○	●	When the EV charging cable malfunctions Stop using the EV charging cable immediately and contact a MITSUBISHI MOTORS Authorised Service Point.
●	●	●	If the control box indicator lamp does not illuminate after connecting the charging cable plug to the outlet, check the circuit breaker for the outlet. If the breaker has tripped, the circuit may not be suitable for use with EV charging cable. You should have a licensed electrician inspect and repair the electrical circuit. If the breaker is not tripped, Stop using the EV charging cable and contact a MITSUBISHI MOTORS Authorised Service Point.

EV charging cable

⚠ WARNING

- If the **POWER** or **CHARGING** indicator does not illuminate or the **FAULT** indicator blinks or illuminates during normal charging, please contact a **MITSUBISHI MOTORS** Authorised Service Point.
- Do not charge when the EV charging cable is coiled up.
The cable may be heated and resulting in fire.
- Do not alter or disassemble the EV charging cable. Doing so could cause a fire, electric shock or injury.
- Be sure to install the cap to the normal charge connector and store the EV charging cable in a place where the cable is not exposed to water or dust. Entry of foreign matter such as water or dust in the metal terminal of the normal charge connector or charging cable plug may cause a fire or malfunction. Contact with a metal such as wire or tool may cause a fire, electric shock or malfunction.
- Never force the connection if the EV charging cable or connector shows damage or is not easily connected due to foreign material entering the connector or the outlet. And never use an outlet that is worn, damaged, or will not hold the plug firmly. Doing so could cause fire, an electric shock, or short circuit.

⚠ WARNING

- Pay attention to the following for handling the EV charging cable.
Damage to the cable could cause a fire, electric shock, or short circuit.
- Do not drop the cable or do not give strong impact to it.
- Do not pull with undue force.
- Do not twist.
- Do not drag.
- Do not put an object on top.
- Do not put the cable close to a heating unit including heater.

⚠ CAUTION

- Do not connect the normal charge cable to an outlet that has a lower rating than the current value described on the control box.

📖 NOTE

- All indicators are illuminated momentarily for confirming operation when the charging cable plug is inserted into an outlet. After that the **POWER** indicator and the **CHARGING** indicator is continuously illuminated.
- The **CHARGING** indicator will start to blink when the charging is completed. The **POWER** indicator is continuously illuminated while the charging cable plug is inserted into an outlet.

Handling and storing the control box

E08301201064

3

⚠ CAUTION

- While charging, prevent damage to the control box by attaching a rope as shown in the following illustration.

📖 NOTE

- Use a hook with a load capacity over 4 kg.
- Check the rope has no damage and is not loose before use.

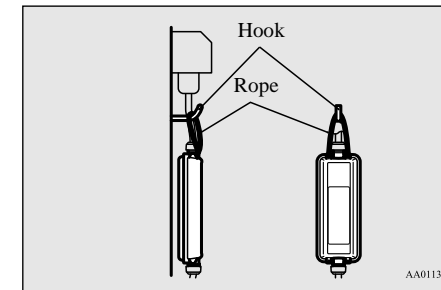

Cleaning the EV charging cable

E08301301065

1. Lightly wipe these off with a soft cloth soaked in a mild soap and water solution.

Charging 3-7

Normal charging (charging method with rated AC 240 V outlet)

2. Wipe off all the detergent with a soft cloth dipped in fresh water and thoroughly wrung out.
3. Wipe all moisture off and dry in a shaded, well-ventilated area.

3

WARNING

- When cleaning, be sure to remove the charging cable plug and the normal charge connector from the outlet. Do not connect or disconnect the plug and the connector with wet hand. Doing so could cause an electric shock.
- Do not expose the metal terminal of the normal charge connector or the charging cable plug to water or neutral detergent. Using in wet with water could cause a fire or an electric shock.

CAUTION

- Never use benzene, petrol, or other organic solvents, or acid or alkaline solvents. Doing so could cause deformation, discolour, or malfunction. Also, these substances may be present in various cleaners, so check carefully before using.

Normal charging (charging method with rated AC 240 V outlet)

E08300901080

WARNING

- For safety, do not allow children or people who are not familiar with charging to charge for themselves. Also, do not use the normal charge connector within reach of children.
- Persons who use electro-medical apparatus such as implantable cardiac pacemaker or implantable cardioverter-defibrillator must check effect from charging with the manufacturer of electro-medical apparatus. Electro-medical apparatus operations could be affected by charging.
- If you use any medical electric devices, be careful the following precautions.
 - Keep away from the charge connector or control box.
 - Do not stay inside of the vehicle.
 - Do not get on inside of the vehicle, for example to remove or place an item in the passenger compartment.
 - Do not open the rear hatch, for example to remove or place an item in the cargo area.

Charging may affect the operation of electric medical devices and result in serious personal injury or death.

WARNING

- Do not charge when the EV charging cable is coiled up. Doing so the cable may be heated and resulting in a fire.
- Before charging, make sure that there is no foreign matter such as dust at the normal charge port and the normal charge connector. At this time, do not touch the normal charge port.
- When foreign substances, such as dust, have entered, please contact a MITSUBISHI MOTORS Authorised Service Point.
- When the normal charge connector is connected to the charge port, prevent foreign matter such as water or dust from entering in the connection. Connection with foreign matter such as water or dust may cause a fire or an electric shock. Do not perform charging if there is possibility of strong exposure to water at the connection.
- When you deal with charge apparatus, be careful of the following points. It could cause a fire, an electric shock and a short circuit.
 - Never pull the cable to remove the plug.
 - Never submerge the EV charging connector, control box, or plug in water.
- Please observe the following in order to prevent accidents during charging such as electrocution.

Normal charging (charging method with rated AC 240 V outlet)

WARNING

- Only use the EV charging cable that is supplied with the vehicle.
- Do not charge another vehicle by the EV charging cable. The cable may over heat and result in a fire.
- When charging outdoors, make sure to use an outlet that is protected from water entering.
- Do not perform charging with the car cover.
- Do not connect or disconnect the plug and connector with wet hands.
- Do not charge the battery if there is a risk of lightning.
- When the EV charging cable or the plug are damaged or it cannot connect by entering a foreign substance, do not connect the EV charging cable by force.
- While it is normal for the connector and charging cable to become warm during charging, discontinue use immediately if the connector or charging cable becomes hot to the touch.
- While it is normal for the control box to become warm during charging, discontinue use immediately if the control box becomes hot to the touch.
- If abnormal smells are detected or the vehicle produces smoke, quickly stop charging.

WARNING

- Do not perform charging in a poorly ventilated area or in an enclosed area. Keep sparks, cigarettes, and flames away from the auxiliary battery. Flammable gas generated from the auxiliary battery during charging may be trapped, resulting in explosion. If charging is inevitably required, ventilate the area well.
- Grasp the normal charge connector when connecting or disconnecting the EV charging cable. Grasping the cable may damage the cable and could cause an electric shock, short circuit, and/or fire.

CAUTION

- During charging, the cooling fans inside the engine room may automatically be operated even if the operation mode of the power switch is OFF. Keep your hands away from the cooling fan during charging.
- Do not perform charging from other power source like a generator. Doing so could cause a malfunction.

NOTE

- If the charge connector is not easily connected to the charge port due to foreign matter entering, never force the connection. Doing so could damage the charging equipment or the vehicle. Please contact a MITSUBISHI MOTORS Authorised Service Point.
- The on board charger is only for rated AC 240 V outlets.
- When connecting or disconnecting the normal charge connector, insert/pull out the connector straight. Also, do not incline or twist the connector. Doing so could cause a bad connection or malfunction.
- Make sure to lock the doors to prevent theft, etc. during charging.

3

Charging port courtesy lamp

E08304101035

The charging port courtesy lamp (A) illuminates when the charging lid is opened.

Normal charging (charging method with rated AC 240 V outlet)

3

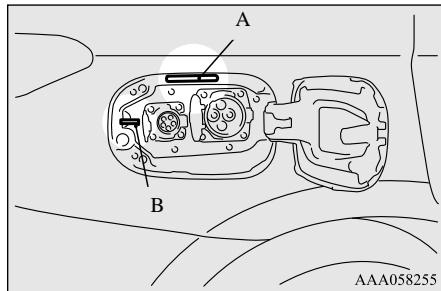

Press the charging port courtesy lamp switch (B) to turn on the charging port courtesy lamp again.

NOTE

- The charging port courtesy lamp illuminating time can be adjusted. For details, please consult a MITSUBISHI MOTORS Authorised Service Point.
- When the select position is not in “P” (PARK) position, the charging port courtesy lamp does not illuminate when the charging lid is opened.
- If the MITSUBISHI Remote Control is operated when the charging port courtesy lamp is off, the lamp may illuminate.

Charging from rated AC 240 V outlet

E08301001091

1. Firmly apply the parking brake, press the electrical parking switch, then shift the select position in “P” (PARK) position.
2. Turn off electrical equipment such as lamps and put the operation mode of the power switch in OFF.
3. Push the rear portion of the charging lid (A) until it clicks, and open the charging lid.

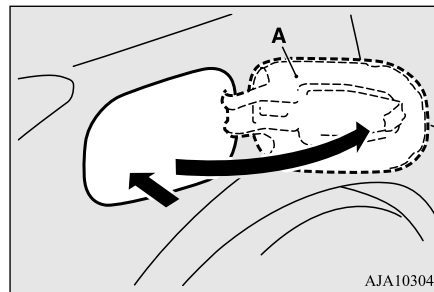

4. Press the tab (B) to open the inner lid (C).

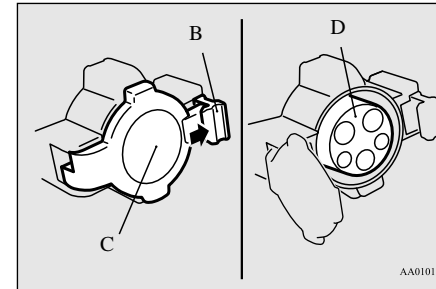

WARNING

- It could cause electric leak, a fire or electric shock by entering water or dust into the normal charge port.
- Do not touch the metal terminal of the normal charge port (D) and the normal charge connector. Doing so could cause an electric shock and/or malfunction.

NOTE

- There is a hole on the charge port for water drainage. If this hole is blocked and water gets trapped in the charge port, do not charge. Please contact a MITSUBISHI MOTORS Authorised Service Point.
- If the charge port is frozen, melt the ice using a hair drier. Forcing the charge connector to connect while frozen could result in malfunction.

Normal charging (charging method with rated AC 240 V outlet)

5. Insert the charging cable plug into an outlet.

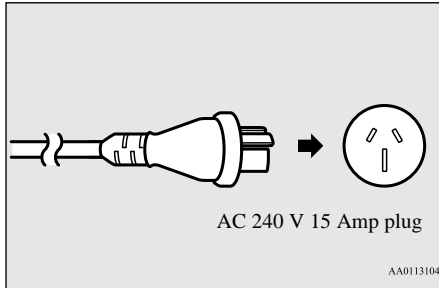

⚠ WARNING

- Make sure that the plug is inserted all the way into the outlet before use. If charging is continued in the state where it is not fully inserted the plug, there is a possibility of generating abnormal heat and resulting in a fire.
- To prevent an electric shock or fire due to electric current leak, perform charging using a waterproofed outlet with earthing which is connected to an earth leakage circuit breaker.

⚠ WARNING

- Always use an earthed outlet protected by a residual current detector, rated for amperage equal to or greater than the value specified by MITSUBISHI MOTORS, and that is connected to a dedicated branch circuit. If the circuit is shared, and another electrical device is being used at the same time the vehicle is charging, the circuit may heat abnormally, the breaker may trip and the circuit may cause adverse interference on the household electrical appliances such as televisions and audio systems.
- Use the rated AC 240 V rated outlet individually. If a multi plug adapter is connected and used with the EV charging cable together with other devices, the outlet may overheat, resulting in a fire.
- Use an outlet for EV charging which waterproofing processing is carried out if the installed position is outdoors or may get wet by rain etc.

⚠ CAUTION

- Use the outlet that is installed approx. 1 meter above the ground. If the outlet position is too low, the control box may touch the ground, which may lead to troubles such as submersion in water or getting trampled on.

📖 NOTE

- Check it corresponds an outlet to your vehicle which is installed in the following places.
 - In your house etc.
 - In a parking lot or garage

3

6. Remove the cap (E) on the normal charge connector (F) and make sure that there is no foreign matter such as dust at the end of the normal charge connector and the normal charge port.

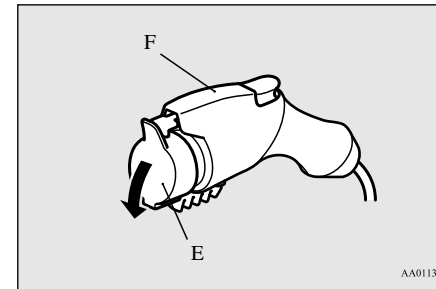

Normal charging (charging method with rated AC 240 V outlet)

7. Connect the normal charge connector until a click sound is heard without pressing the button (G).

3

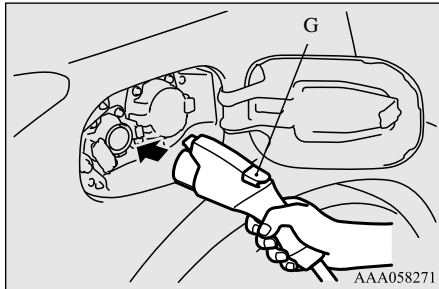

CAUTION

- Do not clasp the top of normal charge connector. It could cause injury to touch the protrusion on the lid.

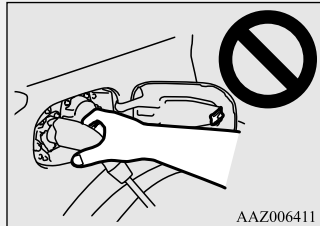

NOTE

- When put the operation mode of the power switch in "ON" with the normal charge connector connected to the normal charge port, the plug-in hybrid EV system cannot be started.
- Do not perform connect or disconnect the normal charge connector repeatedly for a short time. Charging may not be started.
- Even if the power switch is ON with the normal charge connector is inserted in the normal charge port, it will not be in the state which can be driven. During charging, if you want to put the operation mode in OFF, when the operation mode of the power switch is ON, make sure the select position is in "P", take your foot off the brake pedal and press the power switch. If the brake pedal is depressed, the operation mode cannot be put in OFF.

Normal charging (charging method with rated AC 240 V outlet)

8. Make sure that the charging indicator (H) on the instrument cluster is illuminated.

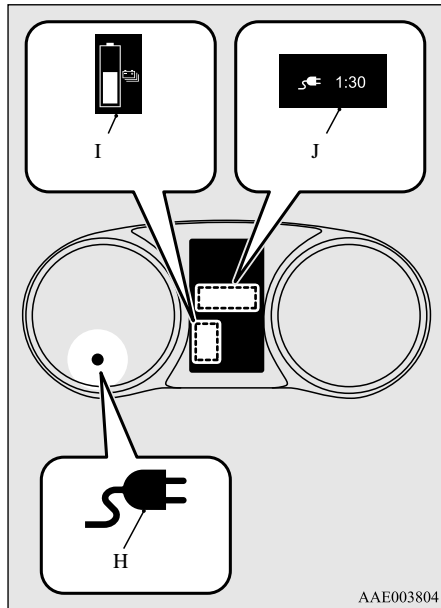

If the charging indicator is not illuminated, charging has not started. Make sure that the normal charge port and the plug are correctly connected, and perform charging from Step 5 again.

NOTE

- When the normal charge connector is connected to the charge port, the charging indicator will blink. When charging is started, the charging indicator is illuminated.
- If one of the doors is opened or the multi-information display switch is operated, the drive battery level display (I) appears in the multi-information display and indicates the drive battery level. In addition, when the remaining time is less than 1 hour, the predicted charging time display (J) appears --:-- and does not indicate a malfunction.

9. Charging is complete when the charging indicator turns off. Pull out the normal charge connector while pressing the button (K).

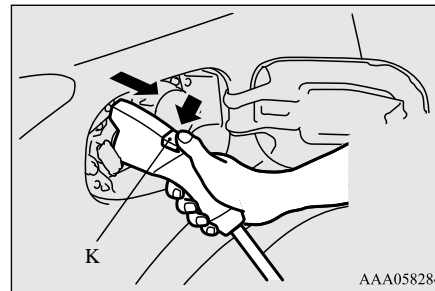

CAUTION

- Be sure to check the normal charge connector is removed from the normal charge port. Since it will change into the state which can be started the vehicle when the power switch is operated if the normal charge connector does not locked completely, resulting in an unexpected accident.

3

NOTE

- Charging can be stopped half way. In this case, also, pull out the normal charge connector while pressing the button. Pressing the manual stop button on the control box can also stop charging. Refer to “EV charging cable” on page 3-5.

10. Close the inner lid and press the rear of the normal charging lid until it clicks to close it.

NOTE

- Make sure that the inner lid is completely closed. If the normal charging lid is forcibly closed without completely closing inner lid, the hinge on the inner lid may be broken.

11. Remove the charging cable plug from the outlet.

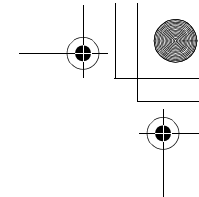
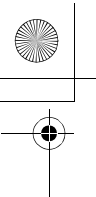

Normal charging (charging method with rated AC 240 V outlet)

12. Install the cap on the normal charge connector.

3

⚠ WARNING

- After charging, be sure to close the inner lid and the normal charging lid completely.
Be careful that water or dust does not enter in the normal charge port, inner lid and normal charge connector.
Entry of water or dust could cause electric current leakage, resulting in a fire or electric shock.
- After charging, be sure to disconnect the charge connector from the charge port.
If the charge connector is only partially engaged and the connector latch is unlocked, you could put the operation mode of the power switch in “ON” and the vehicle could start moving. It could lead to an unexpected accident.
- After charging, be sure to disconnect the plug from the outlet.
If the plug is left connected to the outlet, immersion in water or tampering may cause leakage or an electric shock.

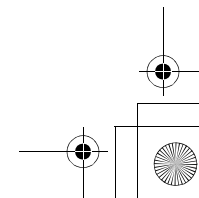
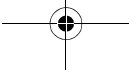
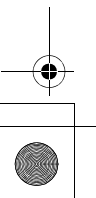
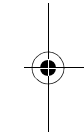
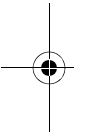

Charging troubleshooting guide

E08301501054

Symptom	Possible cause	Possible solution
Charging cannot be started.	The operation mode of the power switch in ON	Put the operation mode of the power switch in "OFF" before charging.
	The drive battery is already fully charged.	Charging cannot be performed if the drive battery is already fully charged. Charging automatically turns off if the drive battery is fully charged.
	The temperature of the drive battery is too high or too low to charge.	Confirm the drive battery temperature. Refer to "Cautions and actions to deal with intense heat" on page 2-8 and "Cautions and actions to deal with intense cold" on page 2-9.
	The auxiliary battery is discharged.	The drive battery can not be charged if the vehicle electrical systems cannot be turned on. If the auxiliary battery is discharged, charge or emergency start the auxiliary battery. Refer to "Emergency starting" on page 9-2.
	The vehicle or the charging cable has a malfunction.	The vehicle or charging cable may have a malfunction. Confirm if the warning lamp on the meter is illuminated. Confirm if the indicator on the control box is indicating a malfunction. If a warning is displayed, stop charging and contact a MITSUBISHI MOTORS Authorised Service Point.

3

Charging troubleshooting guide

3

Symptom	Possible cause	Possible solution
Normal charging cannot be started.	There is no electrical power coming from the outlet.	Confirm that there has not been a power failure. Make sure the breaker is on. If an outlet with a timer device installed is used, power will only be available at the time set by the timer. Confirm if the POWER indicator on the control box is illuminated.
	The charge connector is not connected correctly.	Confirm the charge connector is connected correctly.
	The charge connector was connected and disconnected repeatedly in a short time.	Disconnect the charge connector, wait for a while, then start charging procedure again from the beginning.
	A charging cable for other vehicle is used.	Use the EV charging cable only for your vehicle.
	A normal charger which does not correspond to your vehicles is used.	Consult an administrator or a maker of the normal charger that it corresponds to your vehicle. Also perform normal charging according to the operating procedure indicated on the body of normal charger.
	Reservation of charging timer is set up by MITSUBISHI Remote Control. (Vehicle with MITSUBISHI Remote Control)	The normal charging can not be started when the charging cable is connected, if the charging timer is set. Cancel all the charging timer settings, if you want to start the normal charging immediately.

MITSUBISHI Remote Control*

3

Symptom	Possible cause	Possible solution
Normal charging is discontinued.	There is no power coming from the outlet.	There may have been a electrical power failure, or the breaker may have failed.Charging will resume when the power source is reset.
	The EV charging cable has been disconnected.	Check that the EV charging cable has not been disconnected.
	The button on the normal charge connector has been pressed.	If the charge connector button is pressed for a long period of time, charging will be stopped. Start the charging procedure again.
	The temperature of the drive battery is too high or too low to charge.	Confirm the drive battery temperature. Refer to “Cautions and actions to deal with intense heat” on page 2-8 and “Cautions and actions to deal with intense cold” on page 2-9.
	Charging is stopped by the normal charge timer.	Charging will stop depending on the timer function setting of the normal charge device. If you need to charge the drive battery more, start the charging procedure again.
	The Charging timer was set up by the MITSUBISHI Remote Control after starting of normal charging.	Cancel all the charging timer settings. Charging is automatically restarted if you cancel the charging timer.

MITSUBISHI Remote Control*

E08304200026

The MITSUBISHI Remote Control allows to operate the vehicle within the communication range of the wireless LAN device (which conforms to IEEE 802.11b and supports iOS or Android). The following operations are available.

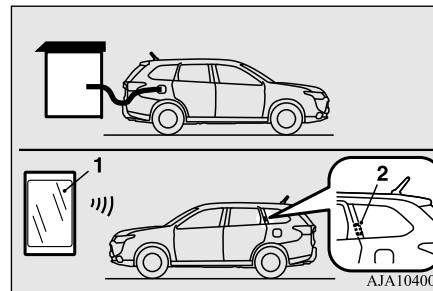

- 1- Wireless LAN device
- 2- Antenna

- Charging timer
If you specify the charge start and/or stop time with the normal charge cable connected, charging is started and/or stopped at that time.
- Remote climate control
By setting the remote climate control to operate at a predetermined time, cabin comfort can be improved or visibility can be ensured (defrosting/demisting) before getting on the vehicle.

MITSUBISHI Remote Control*

3

● Customize (function setting change)

The function setting of the keyless operation system, security alarm, outside rear-view mirror, operation mode of the power switch, air conditioning, lamps and wind-screen wipers can be changed by MITSUBISHI Remote Control.

NOTE

- The electric heater is required to activate the reservation functions of heater, defroster and demister.
- Due to the communication distance differs depending on the wireless LAN device, the communication may down.

Devices that support wireless LAN are required to communicate with the vehicle using the MITSUBISHI Remote Control. Also, an SSID* (A) and password (B) are required to connect a wireless LAN device to the vehicle. The SSID and password come with the key at the time of your purchase of the vehicle.

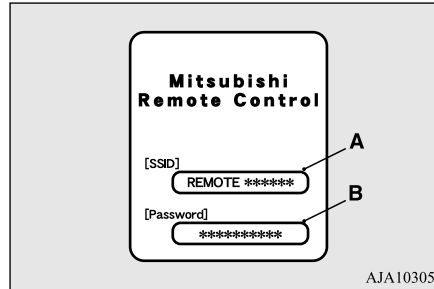

*: An SSID is the identifier of an access point for IEEE 802.11 series wireless LAN. It is displayed on wireless LAN devices.

For the operation method of the MITSUBISHI Remote Control, please visit Mitsubishi Motors' Web site:

http://www.mitsubishi-motors.com/en/products/outlander_phev/app/remote/index.html

- If you need further information, please contact a MITSUBISHI MOTORS Authorized Service Point.

WARNING

- Do not use the MITSUBISHI Remote Control if children, persons in need of care, pets, etc. are in the vehicle. Even if the remote climate control is used, the cabin may become hot or cold due to some reasons such as automatic stop of the system. The cabin temperature may quickly rise in sunshine, which poses a risk of heat stroke and dehydration. In cold weather, on the other hand, the cabin temperature may quickly drop. Either of which could lead to death in the worst case.
- The cooling fan in the engine compartment may operate automatically when charging or when operating air conditioner. Do not bring your hand close to the cooling fan during charging.

CAUTION

- Do not use the timer charging or the remote climate control with a car cover.

NOTE

- Keep the following points in mind when using a wireless LAN device:
 - Communication speed and range vary depending on the wireless LAN devices and the surrounding conditions (radio environment, obstacles, parking area environment, etc.).

MITSUBISHI Remote Control*

NOTE

- Due to the characteristics of radio waves, communication speed tends to decrease as the communication distance increases. Use your wireless LAN device at a short distance from the vehicle for better response.
- When a microwave oven or ISM (industrial, scientific and medical) equipment is being used, the communication speed and range of wireless LAN devices may decrease. Use your wireless LAN device away from these appliances and equipment.
- If a wireless LAN device and Bluetooth (registered trademark of Bluetooth SIG, Inc.) are used simultaneously, the communication speed and range of each device may decrease. Use your wireless LAN device away from Bluetooth devices.
- Wireless LAN devices may not communicate with the vehicle, or may not operate normally or stably in the following environment or situations. Check that the device can communicate with your vehicle before use.
 - There is an obstruction such as a concrete or metal wall between the vehicle and wireless LAN device.
 - The vehicle is surrounded by tall vehicles in a parking lot.
 - There are facilities nearby that emit strong radio waves, such as a TV tower, transformer substation, broadcasting station or airport.

NOTE

- There is a communication device such as a mobile phone or radio, or an electric device such as a personal computer near the wireless LAN device.
- The wireless LAN device is in contact with or covered by a metal object.
- The battery of the wireless LAN device has run down.
- The MITSUBISHI Remote Control cannot be used under the following conditions:
 - The wireless LAN device is turned off.
 - The MITSUBISHI Remote Control application software is not installed.
 - The MITSUBISHI Remote Control application software is not running.
 - The wireless LAN device is not registered on the vehicle or it is not connected to the vehicle.
 - The wireless LAN device is out of the communication range.
 - The wireless LAN device is connected to other wireless LAN device.
 - The wireless LAN device has failed, or its battery has run out.
- Some charging facilities have a timer function that turns the power on or off at a specific time of the day. When charging at a facility with a timer function, make sure that the charging timer is set within the time period when the power in the charging facility is on.

NOTE

- The auxiliary battery is automatically and periodically charged using electrical power stored in the drive battery.
- While the remote climate control is operating or the charging, the cooling fan or air conditioner compressor may start operating and its sound may be heard. This is normal.
- The remote climate control operates in its own mode based on the mode selected on the wireless LAN device, regardless of the switch setting of the vehicle's air conditioner.
- Air conditioning performance may deteriorate or the remaining quantity of the drive battery may decrease under the following conditions:
 - In extremely hot weather.
 - In hot sunshine.
 - In extremely cold weather.
- If the remote climate control is started during charging, the time until full charge may extend or the charging rate may decrease.
- When the remaining quantity of the drive battery is decreased, the remote climate control does not operate or it may stop on the way.

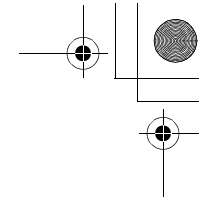
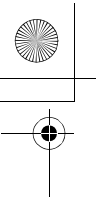

MITSUBISHI Remote Control*

3

NOTE

- When the auxiliary battery is removed, the timer control of the MITSUBISHI Remote Control is reset and each function of the MITSUBISHI Remote Control can not be used. Also the drive battery can not be warmed up.
Communicate the wireless LAN device and your vehicle again.

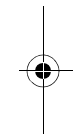
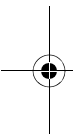

3-20 Charging

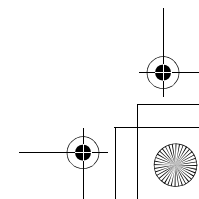
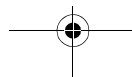
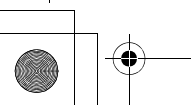

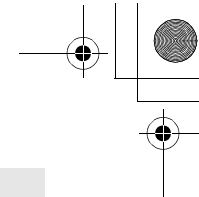
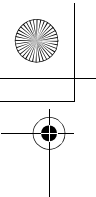

Locking and unlocking

Keys	4-2
Key number tag	4-2
Electronic immobilizer (Anti-theft starting system).....	4-3
Keyless entry system	4-3
Keyless operation system	4-6
Doors.....	4-14
Central door locks.....	4-15
“Child-protection” rear doors	4-15
Tailgate *	4-16
Electric tailgate*	4-17
Inside tailgate release.....	4-24
Security alarm system *	4-24
Electric window control.....	4-29
Sunroof *	4-31

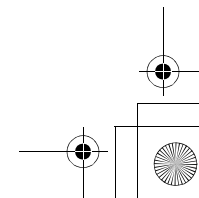
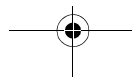
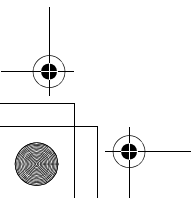
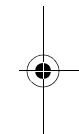
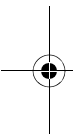

Keys

Keys

E00300103572

The key fits all locks.

4

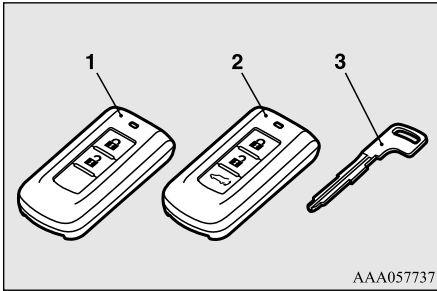

- 1- Keyless operation key
- 2- Keyless operation key (with electric tailgate switch)
- 3- Emergency key

WARNING

- **When carrying a key on flights, do not press any switches on the key while on the plane. If a switch is pressed on the plane, the key emits electromagnetic waves, which could adversely affect the plane's flight operation.**
When carrying a key in a bag, be careful that no switches on the key can be easily pressed by mistake.

NOTE

- The key is a precision electronic part with a built-in signal transmitter. Please observe the following in order to prevent a malfunction.
 - Do not leave anywhere that is exposed to direct sunlight, for example on the dashboard.
 - Do not disassemble or modify.
 - Do not excessively bend the key or subject it to a strong impact.
 - Do not expose to water.
 - Keep away from magnetic key rings.
 - Keep away from audio systems, personal computers, TVs, and any other equipment that generates a magnetic field.
 - Keep away from devices that emit strong electromagnetic waves, such as cellular phones, wireless devices and high frequency equipment (including medical devices).
 - Do not wash with ultrasonic cleaners or similar equipment.
 - Do not leave the key where it may be exposed to high temperature or high humidity.
- The plug-in hybrid EV system is designed so that it will not start if the ID code registered in the immobiliser computer and the key's ID code do not match. Refer to the section entitled "Electronic immobiliser" for details and key usage.

NOTE

- [For vehicles equipped with the security alarm system]
Pay attention to the following if the security alarm is set to "Active".
Refer to "Security alarm system" on page 4-24.
 - If the security alarm is in the system armed mode, the alarm will sound if the doors are opened after being unlocked with the key, the inside lock knob or the central door lock switch.
 - Even if the security alarm is set to "Active", the system preparation mode is not entered if the keyless entry system or the keyless operation function was not used to lock the vehicle.

Key number tag

E00312700011

The key number is stamped on the tag as indicated in the illustration.

Make a record of the key number and store the key and key number tag in separate places, so that you can order a key from your authorised MITSUBISHI MOTORS dealer in the event the original keys are lost.

Electronic immobilizer (Anti-theft starting system)

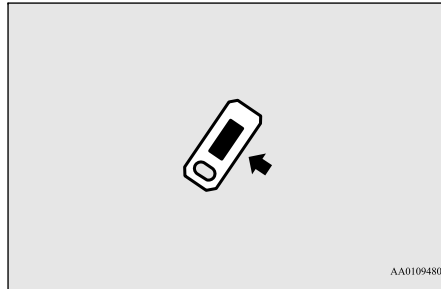

NOTE

- If you lose one of keyless operation keys, contact your MITSUBISHI MOTORS Authorised Service Point as soon as possible. To obtain a replacement or extra spare key, take your vehicle and all remaining keys to your MITSUBISHI MOTORS Authorised Service Point. All the keys have to be re-registered in the immobiliser computer unit. The immobilizer can register as follows.
 - Keyless operation key: up to 4 different keys

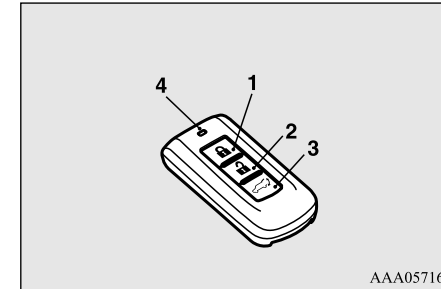

4

- 1- LOCK switch
- 2- UNLOCK switch
- 3- Electric tailgate switch*
- 4- Indicator lamp

Electronic immobilizer (Anti-theft starting system)

E00300202996

The electronic immobilizer is designed to reduce significantly the possibility of vehicle theft. The purpose of the system is to immobilize the vehicle if an invalid start is attempted. A valid start attempt can only be achieved by using a key “registered” to the immobilizer system.

NOTE

- If the plug-in hybrid EV system does not start, we recommend you to contact your MITSUBISHI MOTORS Authorised Service Point.

CAUTION

- Do not modify or add parts to the immobilizer system. Doing so could cause the immobilizer to malfunction.

Keyless entry system

E00300303721

Press the remote control switch, and all doors and the tailgate will be locked or unlocked as desired. It is also possible to operate the outside rear-view mirrors.

To lock

Press the LOCK switch (1). All the doors and the tailgate will be locked. The turn-signal lamps will blink once when the doors and the tailgate are locked.

To unlock

Press the UNLOCK switch (2). All the doors and the tailgate will be unlocked. If the doors and tailgate are unlocked when the front room lamp switch is in the “DOOR” position or the rear room lamp switch is in the middle (●) position, the room lamp will illuminate for

Keyless entry system

approximately 15 seconds and the turn-signal lamps will blink twice.

The position and tail lamps can also be set to turn on for about 30 seconds. Refer to “Instruments and controls: Welcome light” on page 6-43.

4

NOTE

- The door and tailgate unlock function can be set so that only the driver's door unlocks when the UNLOCK switch (2) is pressed once.
If the door and tailgate unlock function is set to work as described above, all the doors and the tailgate unlock when the UNLOCK switch is pressed two times in succession. Refer to “Setting of door and tailgate unlock function” on page 4-5.
- If the UNLOCK switch (2) is pressed and any of the doors or tailgate is not opened within approximately 30 seconds, relocking will automatically occur.
- It is possible to modify functions as follows:
For further information, please contact your MITSUBISHI MOTORS Authorised Service Point.
On vehicles equipped with Mitsubishi Multi-Communication System (MMCS), screen operations can be used to make the adjustment. Refer to the separate owner's manual for details.
- The time for automatic relocking can be changed.

NOTE

- The confirmation function (blinking of the turn-signal lamps) can be set to operate only when the doors and tailgate are locked or only when the doors and tailgate are unlocked.
- The confirmation function (this indicates locking or unlocking of the doors and tailgate with the blink of the turn-signal lamps) can be deactivated.
- The number of times the turn-signal lamps are blinked by the confirmation function can be changed.

Operation of the outside rear-view mirrors (Vehicles equipped with the mirror retractor switch)

E00310801259

To fold

Within 30 seconds of locking the doors and tailgate using the LOCK switch (1), press the LOCK switch twice rapidly to fold the outside rear-view mirrors.

To extend

Within 30 seconds of unlocking the doors and tailgate using the UNLOCK switch (2), press the UNLOCK switch twice rapidly to return the outside rear-view mirrors to their extended positions.

The outside rear-view mirrors are not initially set to work as described above. If you want them to work as described above, you need to set them so that they do not retract/extend when the doors and tailgate are locked/unlocked using the keyless entry system or keyless operation function.

Refer to “Starting and driving: Outside rear-view mirrors” on page 7-7.

For details, please consult a MITSUBISHI MOTORS Authorised Service Point.

In a vehicle equipped with the Mitsubishi Multi-Communication System (MMCS), it is possible to change the setting by means of screen operations.

Refer to the separate owner's manual for details.

NOTE

- The outside rear-view mirrors automatically retract when all the doors and tailgate are locked using the keyless operation function. Refer to “Starting and driving: Outside rear-view mirrors” on page 7-7.

Keyless entry system

NOTE

- The keyless entry system does not operate when the door or tailgate is open.
- The remote control switch will operate within about 4 m from the vehicle. However, the operating range of the remote control switch may change if the vehicle is located near a power station, or radio/TV broadcasting station.
- If either of the following problems occurs, the battery may be exhausted.
 - The remote control switch is operated at the correct distance from the vehicle, but the doors and tailgate are not locked/unlocked in response.
 - The indicator lamp (4) is dim or does not come on.

For further information, please consult your MITSUBISHI MOTORS Authorised Service Point.

If you replace the battery yourself, refer to “Procedure for replacing the remote control switch battery” on page 4-5.

- If your remote control switch is lost or damaged, please contact your MITSUBISHI MOTORS Authorised Service Point for a replacement remote control switch.
- If you wish to add a remote control switch, we recommend you to contact your MITSUBISHI MOTORS Authorised Service Point.

The below remote control switches are available for your vehicle.

NOTE

- Keyless operation key: up to 4 remote control switches

Setting of door and tailgate unlock function

E00310301296

The door and tailgate unlock function can be set to the following two conditions. Each time the door and tailgate unlock function is set, a chime will sound to tell you the condition of the door and tailgate unlock function.

Number of chimes	Condition
One chime	All doors and the tailgate unlock
Two chimes	Driver's door unlock only

1. Put the operation mode in OFF.
2. Place the combination headlamps and dipper switch in the “OFF” position, and leave the driver's door open.
3. Press the LOCK switch (1) for 4 to 10 seconds and press the UNLOCK switch (2) during this time.

4. Release in sequence the LOCK and UNLOCK switches within 10 seconds of pressing the LOCK switch in step 3.

NOTE

- On vehicles equipped with Mitsubishi Multi-Communication System (MMCS), screen operations can be used to make the adjustment. Refer to the separate owner's manual for details.

4

Procedure for replacing the remote control switch battery

E00309501243

Before replacing the battery, remove static electricity from your body by touching a metal grounded object.

Keyless operation system

1. With the MITSUBISHI mark facing you, insert the cloth-covered tip of a straight blade (or minus) screwdriver into the notch in the case and use it to open the case.

4

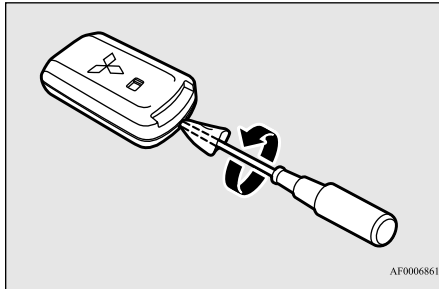

NOTE

- Be sure to perform the procedure with the MITSUBISHI mark facing you. If the MITSUBISHI mark is not facing you when you open the case, the transmitter may come out.

2. Remove the old battery.

3. Install a new battery with the + side (A) up.

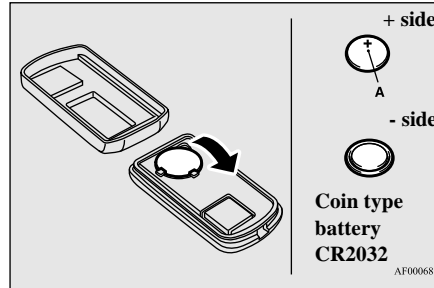

4. Close the case firmly.

5. Check the keyless operation function to see that it works.

NOTE

- You may purchase a replacement battery at an electric appliance store.
- A MITSUBISHI MOTORS Authorised Service Point can replace the battery for you if you prefer.

CAUTION

- When the remote control switch case is opened, be careful to keep water, dust, etc. out. Also, do not touch the internal components.

Keyless operation system

E00305601608

The keyless operation system allows you to lock and unlock the doors and tailgate and start the engine simply by carrying the keyless operation key with you.

The keyless operation key can also be used as the keyless entry system remote control switch.

Refer to “Keyless entry system” on page 4-3.

The driver should always carry the keyless operation key. This key is necessary for locking and unlocking the doors and tailgate, starting the engine and otherwise operating the vehicle, so before locking and leaving the vehicle, be sure to check that you have the keyless operation key.

WARNING

- People with implantable cardiac pacemakers or implantable cardiovascular-defibrillators should not go near the exterior transmitters (A) or the interior transmitters (B). The radio waves used by the keyless operation system could adversely affect implantable cardiac pacemakers or implantable cardiovascular-defibrillators.

Keyless operation system

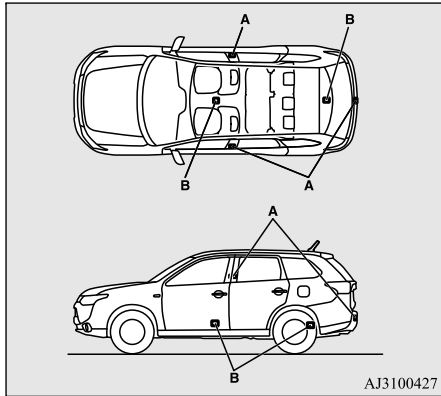

⚠ WARNING

- When using electromedical devices other than implantable cardiac pacemakers or implantable cardiovascular-defibrillators, contact the electromedical device manufacturer ahead of time to determine the affects of radio waves on the devices. Electromedical device operations could be affected by radio waves.

You can limit the possible operations of the keyless operation system in the following ways. (The keyless operation system can be used as a keyless entry system.) Please consult a MITSUBISHI MOTORS Authorised Service Point.

- You can limit operations to locking and unlocking the doors and tailgate.
- You can limit operations to starting the engine.
- The keyless operation system can be disabled.

When keyless operation system operations are modified, the transmitters operate as follows.

- Only locking and unlocking doors or tailgate: exterior transmitter and interior transmitter
- Only starting the engine: interior transmitter

📖 NOTE

- The keyless operation key uses an ultra-weak electromagnetic wave. In the following cases, the keyless operation system may not operate properly or may be unstable.
 - When there is equipment nearby that emits strong radio waves, such as a power station, a radio/TV broadcasting station or an airport.
 - The keyless operation system is carried together with a communications device such as a cellular phone or radio set, or with an electronic device such as a personal computer.
 - The keyless operation key is touching or covered by a metal object.

📖 NOTE

- A keyless entry system is being used nearby.
- When the keyless operation key battery is worn out.
- When the keyless operation key is set down in an area with strong radio waves or noise. In such cases, use the emergency key. Refer to “To operate without using the keyless operation function” on page 4-13.
- Because the keyless operation key receives signals in order to communicate with the transmitters in the vehicle, the battery continually wears down regardless of keyless operation key use. The battery life is 1 to 3 years, depending on usage conditions. When the battery wears out, replace the battery according to the description in this manual or have it replaced at your MITSUBISHI MOTORS Authorised Service Point. Refer to “Procedure for replacing the remote control switch battery” on page 4-5.
- Because the keyless operation key continually receives signals, strong radio wave reception could affect battery wear. Do not leave the key near a TV, personal computer, or other electronic device.

4

Operating range of the keyless operation system

E00305700556

If you are carrying the keyless operation key, enter the operating range of the keyless operation system.

Locking and unlocking 4-7

Keyless operation system

ation system, and press the driver's or front passenger's door lock/unlock switch, the tailgate LOCK switch or the tailgate open switch, the ID code for your key is verified.

You can only lock and unlock the doors and tailgate and start the engine if the ID codes of your keyless operation key and the vehicle match.

4

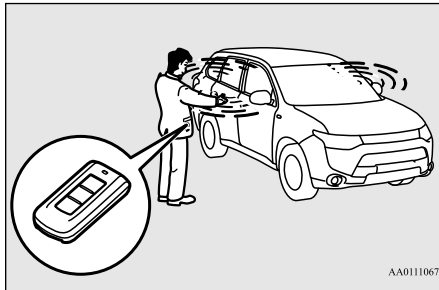

NOTE

- If the keyless operation key battery is wearing out or there are strong electromagnetic waves or noise present, the operating range may become smaller and operation may become unstable.

Operating range for locking and unlocking the doors and tailgate

E00306200516

The operating range is about 70 cm from the driver's door handle, front passenger's door handle, and tailgate handle.

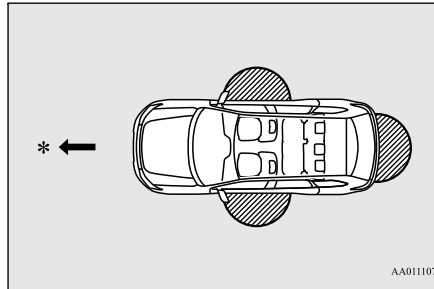

*: Forward direction

: Operating range

NOTE

- Locking and unlocking are only possible when the door or tailgate is operated while the keyless operation key is being detected.
- Operation may not be possible if you are too close to the front door, door window, or tailgate.

NOTE

- Even if the keyless operation key is within 70 cm of the driver's door handle, front passenger's door handle, or tailgate handle, if the key is near the ground or high up, the system may not operate.
- If the keyless operation key is within the operating range, even someone not carrying the key can lock and unlock the doors and tailgate by pressing the driver's or front passenger's door lock/unlock switch, the tailgate lock switch or the tailgate open switch.

Operating range for starting the engine

E00306300285

The operating range is the interior of the vehicle.

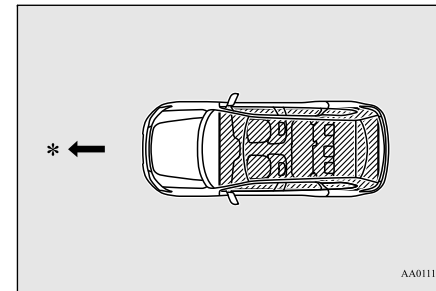

*: Forward direction

: Operating range

Keyless operation system

NOTE

- Even if it is within the operating range, if the keyless operation key is in a small item holder such as the glove box, on top of the instrument panel, door pocket or in the luggage area, it may be impossible to start the engine.
- If you are too close to the door or door window, the engine may start even though the keyless operation key is outside the vehicle.

Driver's or front passenger's door lock/unlock switches

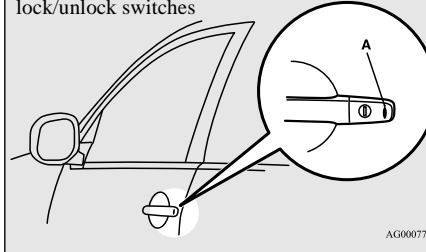

Tailgate switches

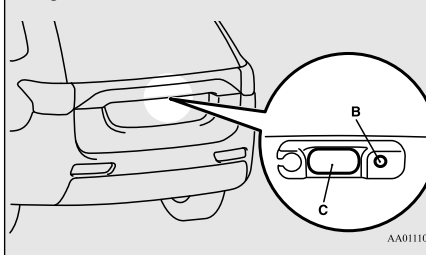

NOTE

- For vehicles equipped with the mirror retractor switch, the outside rear-view mirrors automatically retract when all the doors and tailgate are locked using the keyless operation function.
Refer to "Starting and driving: Outside rear-view mirrors" on page 7-7.
- The keyless operation function does not operate under the following conditions:

NOTE

- The keyless operation key is inside the vehicle.
- A door or the tailgate is open or ajar.
- The tailgate open switch (C) can be used to check that the vehicle is locked properly. Press the tailgate open switch within about 3 seconds of locking the vehicle. If you wait longer than 3 seconds and press the tailgate open switch, the doors and tailgate will be unlocked.
- The time allowed for checking that the vehicle is locked can be adjusted. For further information, please contact your authorised MITSUBISHI MOTORS dealer. On vehicles equipped with Mitsubishi Multi-Communication System (MMCS), screen operations can be used to make the adjustment. Refer to the separate owner's manual for details.

4

To operate using the keyless operation function

E00305800922

Locking the doors and tailgate

When you are carrying the keyless operation key, if you press the driver's or front passenger's door lock/unlock switch (A), or the tailgate LOCK switch (B) within the operating range, the doors and the tailgate are locked. The turn-signal lamps will blink once. Also refer to "Locking and unlocking: Doors, Central door locks, Tailgate" on pages 4-14, 4-15 and 4-16.

Unlocking the doors and tailgate

When you are carrying the keyless operation key, if you press the driver's or front passenger's door lock/unlock switch (A), or the tailgate open switch (B) within the operating range, all the doors and the tailgate are unlocked.

If the front room lamp switch is in the "DOOR" position or the rear room lamp switch is in the middle (●) position at this

Keyless operation system

time, the room lamp will turn on for 15 seconds. The turn-signal lamps will blink twice. If the driver's or front passenger's door lock/unlock switch is pressed and any of the doors or tailgate is not opened within approximately 30 seconds, relocking will automatically occur.

4

Also refer to "Locking and unlocking: Doors, Central door locks, Tailgate" on pages 4-14, 4-15 and 4-16.

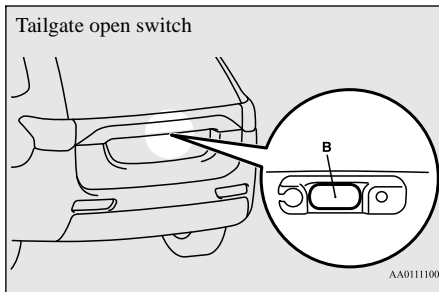
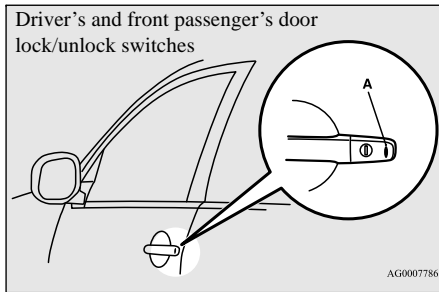

4-10 Locking and unlocking

NOTE

- For vehicles equipped with the mirror retractor switch, the outside rear-view mirrors automatically extend when all the doors and tailgate are unlocked using the keyless operation function. Refer to "Starting and driving: Outside rear-view mirrors" on page 7-7.
- The keyless operation function can be set so that only the driver's door unlocks when the driver's door lock/unlock switch is pressed. If the keyless operation function is set to work as described above, all the doors and the tailgate unlock when the driver's door lock/unlock switch is pressed two times in succession. Refer to "Setting of door and tailgate unlock function" on page 4-5.
- The keyless operation function does not operate under the following conditions:
 - A door or the tailgate is open or ajar.
- In order to make it possible to check that the doors and tailgate are locked, you cannot unlock them by using the tailgate open switch for 3 seconds after locking them.
- The time allowed for checking that the vehicle is locked can be adjusted. For further information, please contact your authorised MITSUBISHI MOTORS dealer. On vehicles equipped with Mitsubishi Multi-Communication System (MMCS), screen operations can be used to make the adjustment. Refer to the separate owner's manual for details.

NOTE

- The time between unlocking and automatic locking can be adjusted. Please consult a MITSUBISHI MOTORS Authorised Service Point. On vehicles equipped with Mitsubishi Multi-Communication System (MMCS), screen operations can be used to make the adjustment. Refer to the separate owner's manual for details.

Operation confirmation when locking and unlocking

Operation can be confirmed as shown below. However, the room lamp will only illuminate if the front room lamp switch is in the "DOOR" position or the rear room lamp switch is in the middle (●) position.

When lock-The turn-signal lamps blink once.
 When unlocking: The room lamp illuminates for about 15 seconds, the turn-signal lamps blink twice.

NOTE

- Functions can be modified as stated below. For further information, please contact your MITSUBISHI MOTORS Authorised Service Point. On vehicles equipped with Mitsubishi Multi-Communication System (MMCS), screen operations can be used to make the adjustment. Refer to the separate owner's manual for details.

NOTE



- Set the confirmation function (blinking of the turn-signal lamps) to operate only when the vehicle is locked or only when the vehicle is unlocked.
- Disable the operation confirmation function (blinking of the turn-signal lamps).
- Change the number of blinks for the operation confirmation function (blinks of the turn-signal lamps).

Warning activation

E00305901715



In order to prevent vehicle theft or the accidental operation of the keyless operation system, the buzzer and the display on the information screen in the multi-information display are used to alert the driver.

If a warning is activated, always check the vehicle and the keyless operation key. The warning is also displayed if there is a fault in the keyless operation system.

Item	Display	Buzzer	Note (Solution)
Detection of failure		Inner buzzer sounds once	There is a fault in the keyless operation system.
Fall of battery voltage		Inner buzzer sounds once	The battery starts to run out, the warning is activated. (The warning is not activated if the battery is completely dead.)



Keyless operation system

4

Item	Display	Buzzer	Note (Solution)
Key not detected		Inner buzzer sounds once	<p>When the engine switch is turned to the ACC or ON from OFF or when the engine is started, the warning is activated, if any of the following conditions is occurred.</p> <ul style="list-style-type: none"> • Carrying another keyless operation key with a different code, or the keyless operation key could be outside the operating range. • The battery of the keyless operation key is dead. • Communication is blocked by electric wave environment.
Keyless operation key reminder		<p>Inner buzzer sounds about 1 minute</p> <p>Outer buzzer sounds about 3 seconds intermittently</p>	<p>If the operation mode is in OFF and the driver's door is opened with the keyless operation key in the key slot, a warning is issued and the outer buzzer sounds for about 3 seconds and the inner buzzer sounds for about 1 minute to remind you to remove the key. If the key removed from key slot, the buzzer is stopped.</p>
Keyless operation key take-out monitoring system		<p>Inner buzzer sounds once</p> <p>Outer buzzer sounds intermittently</p>	<ul style="list-style-type: none"> • When the vehicle is parked with the operation mode in any mode other than OFF, if you close the door after opening any of the doors and taking the keyless operation key out of the vehicle, a warning is issued until the key is detected in the vehicle. • If you take the keyless operation key out of the vehicle through a window without opening a door, the keyless operation key take-out monitoring system does not operate. • It is possible to change the setting to make the keyless operation key take-out monitoring system operate if you take the keyless operation key out from the vehicle through a window without opening a door. For further information, please contact a MITSUBISHI MOTORS Authorised Service Point. • Even if you have the keyless operation key within the engine start operating range, if the keyless operation key and vehicle ID codes cannot be matched, for example due to the ambient environment or electromagnetic conditions, the warning may be activated.

Keyless operation system

4

Item	Display	Buzzer	Note (Solution)
Key lock-in prevention system		Inner buzzer sounds once Outer buzzer sounds about 3 seconds intermittently	<ul style="list-style-type: none"> When the operation mode is in OFF, if you close all the doors and the tailgate with the keyless operation key left in the vehicle and you try to lock the doors and tailgate by pressing the driver's or front passenger's door lock/unlock switch, or the tailgate LOCK switch, a warning is issued and you cannot lock the doors and tailgate. Make sure you have the keyless operation key with you before locking the doors. Even if you leave the keyless operation key inside the vehicle, it is possible that the doors will lock depending on the surrounding environment and wireless signal conditions.
Door ajar prevention system		Inner buzzer sounds once Outer buzzer sounds about 3 seconds intermittently	When the operation mode in OFF, if you try to lock the doors and tailgate by pressing the driver's or front passenger's door lock/unlock switch, or the tailgate LOCK switch with one of the doors or the tailgate not completely closed, a warning is issued and you cannot lock the doors and tailgate.
Operation mode OFF reminder system		Inner buzzer sounds once Outer buzzer sounds about 3 seconds intermittently	When the operation mode is in any mode other than OFF, if you close all the doors and the tailgate then try to lock the doors and tailgate by pressing the driver's or front passenger's door lock/unlock switch, or the tailgate LOCK switch, a warning is issued and you cannot lock the doors and tailgate.

To operate without using the keyless operation function

E0030600019

Emergency key

E00307201464

The emergency key is built into the keyless operation key. If the keyless operation function cannot be used, for example because the

keyless operation key battery has worn out or the vehicle battery is flat, you can lock and unlock the driver's door and start the engine with the emergency key.

To use the emergency key (A), unlock the lock knob (B) and remove it from the keyless operation key (C).

Refer to "Doors" on page 4-14, or "If the keyless operation key is not operating properly" on page 7-13.

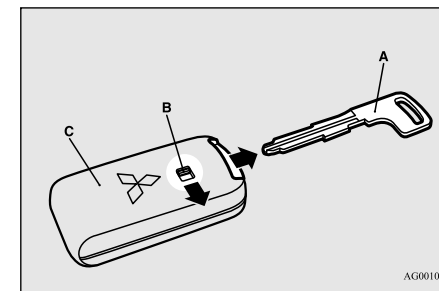

Doors

4

NOTE

- Only use the emergency key for emergencies. If the keyless operation key battery wears out, replace it as quickly as possible so that you can use the keyless operation key.
- After using the emergency key, always return it into the keyless operation key.

Doors

E00300402291

CAUTION

- Make sure the doors are closed: driving with doors not completely closed is dangerous.
- Never leave children in the vehicle unattended.
- Be careful not to lock the doors while the key is inside the vehicle.

NOTE

- To prevent the key from being locked inside the vehicle, neither the lock knob on the driver's door nor the key can be used to lock the driver's door when it is open.

To lock or unlock with the key

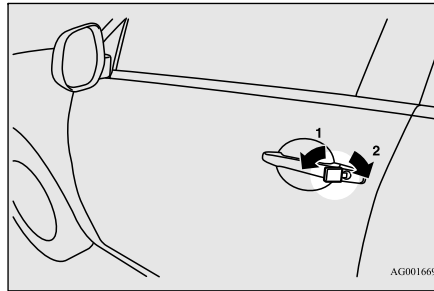

- 1- Lock
- 2- Unlock

NOTE

- When locking or unlocking with the key, only the driver's door will be locked or unlocked. To lock or unlock all doors and the tailgate, use the central door lock switch, the keyless entry system or the keyless operation function. Refer to "Central door locks" on page 4-15, "Keyless entry system" on pages 4-3, and "To operate using the keyless operation function" on page 4-9.
- If the vehicle is equipped with the keyless operation system, the driver's door can be locked or unlocked with the emergency key. Refer to "Emergency key" on page 4-13.

To lock or unlock from inside the vehicle

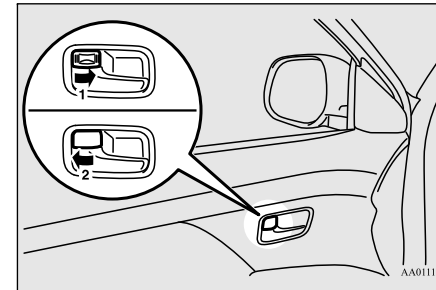

- 1- Lock
- 2- Unlock

Pull the inside door handle towards you to open the door.

NOTE

- The driver's door can be opened without using the lock knob by pulling the inside door handle.

Central door locks

To lock without using the key

Front passenger's door, Rear door

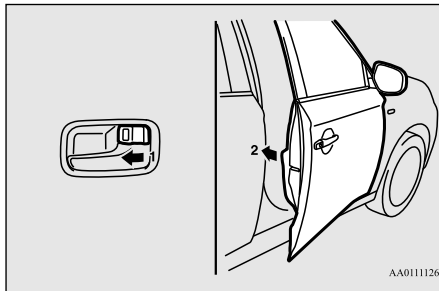

Set the inside lock knob (1) to the locked position and close the door (2).

Central door locks

E00300801937

NOTE

- Repeated continuous operation between lock and unlock could activate the central door locking systems built-in protection circuit and prevent the system from operating. If this occurs, wait about 1 minute before operating the central door lock switch.
- When the driver's door is open, the central door lock switch cannot be used to lock it.

To lock and unlock the doors and tailgate

Using the central door lock switch

Using the central door lock switch on the driver's door locks or unlocks all doors and the tailgate.

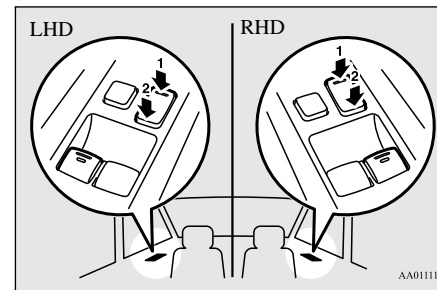

1- Lock

2- Unlock

To unlock the doors and tailgate

E00311301310

You can select the function to unlock the doors and tailgate using the engine switch. This function is not activated when the vehicle is shipped from the factory. To activate or

deactivate this function, please contact a MITSUBISHI MOTORS Authorised Service Point.

Using the power switch

All doors and the tailgate will unlock whenever the operation mode is put in OFF.

4

“Child-protection” rear doors

E00300901042

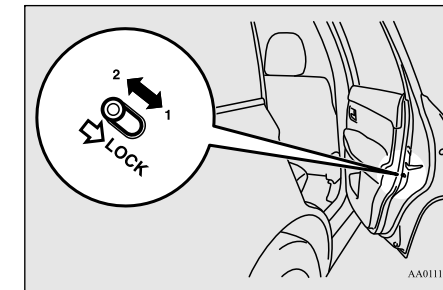

1- Lock

2- Unlock

Child protection helps prevent the rear doors from being opened accidentally from the inside.

Tailgate*

If the lever is set to the locked position, the rear door cannot be opened using the inside handle, but only with the outside handle.

If the lever is set to the “Unlock” position, the child protection mechanism does not function.

4

CAUTION

- When driving with a child in the rear seat, please use the child protection to prevent accidental door opening which may cause an accident.

Tailgate*

E00301401220

WARNING

- It is dangerous to drive with the tailgate open, since carbon monoxide (CO) gas can enter the cabin. You cannot see or smell CO. It can cause unconsciousness and even death.
- When opening and closing the tailgate, make sure that there are no people nearby and be careful not to hit your head or pinch your hands, neck, etc.

To lock/unlock

The tailgate can be locked or unlocked by using the central door lock switch (driver side).

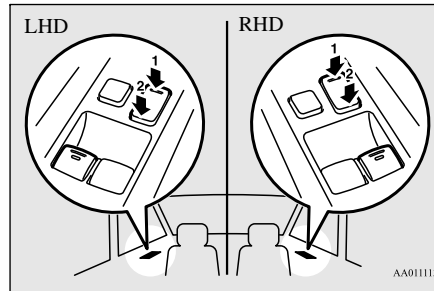

- 1- Lock
- 2- Unlock

NOTE

- Repeated continuous operating between lock and unlock could cause the central door locks' built-in protection circuit to prevent the system from operating. If this occurs, wait about 1 minute before operating the central door lock switch.

To open

After unlocking the tailgate, push the tailgate open switch (A) and pull up the tailgate.

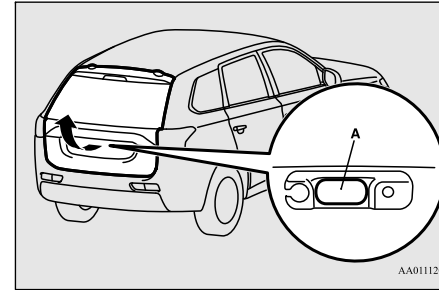

NOTE

- The tailgate cannot be opened when the battery is flat or disconnected. If you want to open the tailgate, it can be opened by using the inside tailgate release. Refer to “Inside tailgate release” on page 4-24.

To close

Pull the tailgate grip (B) downward as illustrated. Gently slam the tailgate from the outside so that it is completely closed. Always ensure the tailgate is securely closed.

Electric tailgate*

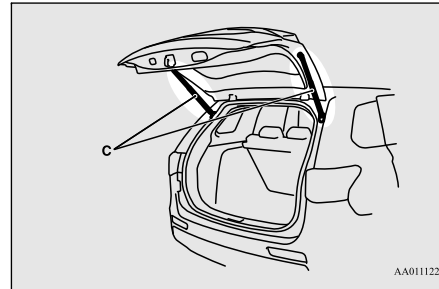
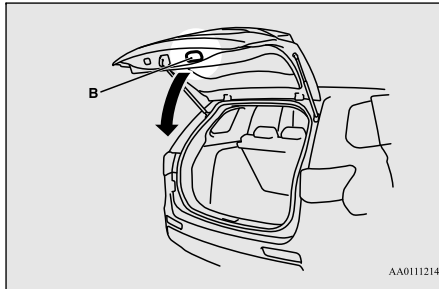

CAUTION

- When closing the tailgate, always ensure your or other person's fingers cannot be caught by the tailgate.

Electric tailgate*

E00312801022

Before operating the electric tailgate, unlock the tailgate by using the keyless entry system, keyless operation function, or the central door locks.

Refer to "Keyless entry system" on page 4-3, "Keyless operation system" on page 4-6, or "Central door locks" on page 4-15.

Operating the electric tailgate

E00312900013

WARNING

- The luggage area was not designed for people to ride in it. Do not let your children ride in or play in the luggage area. Riding or playing in the luggage area could result in a serious accident.

WARNING

- Before driving, make sure the electric tailgate is securely closed. If you drive with the tailgate open, there is a danger of exhaust gas entering the vehicle and causing carbon monoxide poisoning.
- For safety's sake, the electric tailgate should be operated by adults and not children.
- When opening and closing the tailgate, make sure that there are no people nearby and be careful not to hit your head or pinch your hands, neck, etc. Make sure the electric tailgate is completely open before loading and unloading luggage.

NOTE

- Gas struts (C) are installed to support the tailgate. To prevent damage or faulty operation.
 - Do not hold the gas struts when closing the tailgate.
 - Also, do not push or pull the gas struts.
 - Do not attach any plastic material, tape, etc., to the gas struts.
 - Do not tie string, etc., around the gas struts.
 - Do not hang any object on the gas struts.

CAUTION

- Do not stand behind the exhaust pipe when loading and unloading luggage. The heat from the exhaust could cause burns.
- Before driving, make sure the electric tailgate is closed properly. If the tailgate opens when driving, luggage could fall onto the road and cause an accident.
- Do not install accessories other than MITSUBISHI MOTORS GENUINE parts on the electric tailgate. Some accessories could be too heavy, causing the drop prevention mechanism to operate.

Electric tailgate*

4

CAUTION

- When closing the electric tailgate, make sure there is no foreign matter around the striker (A).
If foreign matter gets into the striker it could prevent the electric tailgate from closing normally.

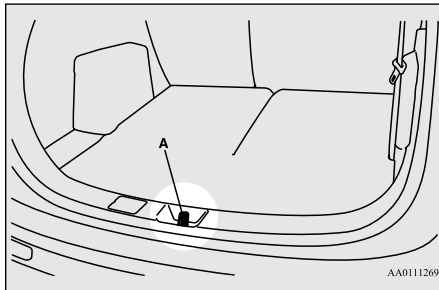

NOTE

- When opening and closing the electric tailgate, do not place your hands near the arm (B).
- Gas struts (C) are installed in the locations shown below in order to support the electric tailgate.
- Make sure not to bump your head in the area near the arm of the electric tailgate when loading and unloading luggage.

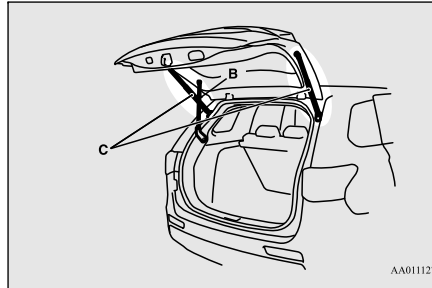

NOTE

- Please observe the following in order to prevent damage or faulty operation.
 - Do not pull on the gas struts when closing the electric tailgate or otherwise push or pull them.
 - Do not attach any plastic material, tape, etc., to the gas struts.
 - Do not tie string, etc., around the gas struts.
 - Do not hang anything from the gas struts.

Automatic operation

E00313001034

The electric tailgate can be operated using the remote control switch on the keyless operation key, or the close switch on the tailgate when the electric tailgate power switch (A) is on.

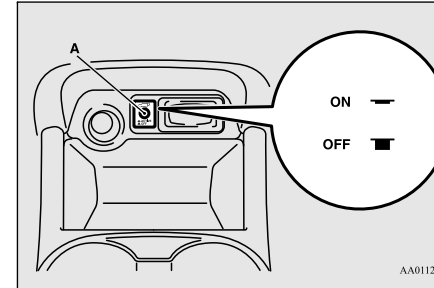

WARNING

- Turn off the electric tailgate power switch when not operating the electric tailgate.
If the switch is left on, someone's hand or head could get caught if the electric tailgate switch or close switch is accidentally operated, or children play with the controls.
- If the electric tailgate power switch is turned off while the tailgate is operating, it will stop moving and switch to manual operation.
At this time, the electric tailgate could open or close suddenly, depending on its position.

CAUTION

- Do not apply excessive force on the electric tailgate when opening or closing it. Doing so could cause a breakdown.

Electric tailgate*

CAUTION

- Do not start the engine while the tailgate is operating. The sudden operation prevention mechanism could operate, making the electric tailgate stop intermittently while it moves.

NOTE

- The electric tailgate cannot be opened when the battery is flat or disconnected. If you want to open the electric tailgate, it can be opened by using the inside tailgate release. Refer to “Inside tailgate release” on page 4-24.
- If the keyless entry system or close switch is operated when the electric tailgate power switch is off, the warning buzzer sounds 4 times to notify the driver that the electric tailgate cannot be operated.
- The electric tailgate does not operate normally under the following conditions:
 - When parked on an incline
 - In strong winds
 - When the electric tailgate is covered with snow
- Repeated continuous operation between opening and closing the electric tailgate will activate the built-in protection circuit and switch the tailgate to manual operation.

NOTE

- If the electric tailgate handle is operated while the tailgate is operating or immediately after it is closed, the tailgate will move in the direction opposite to the one in which it was operating.
- If the battery or fuse is replaced while the electric tailgate is open, it cannot be closed automatically. In this case close the electric tailgate manually.

Operating conditions

E00313101048

The electric tailgate can be opened automatically when all of the following conditions are met.

<Using the keyless operation key>

- The operation mode is in OFF.
- The key is not inserted into the ignition switch.
- The electric tailgate is completely closed.
- The electric tailgate is unlocked.

<Using the driver's side electric tailgate switch>

- The operation mode is in ON with the electrical parking switch is pressed.
- The electric tailgate is completely closed.
- The electric tailgate is unlocked.

<Using the open switch of the electric tailgate>

- The electric tailgate is unlocked.
- The keyless operation key is within the operating range (70 cm from the electric tailgate switch) and the tailgate is locked. The factory setting is “Inactive”. To modify the setting to “Active”, please contact an authorised MITSUBISHI MOTORS dealer.

4

The electric tailgate can be closed automatically when all of the following conditions are met.

<Using the keyless operation key>

- The operation mode is in OFF.
- The electric tailgate is completely open.
- People, luggage, etc., are not touching the sensors.

<Using the driver's side electric tailgate switch or close switch>

- The operation mode is in ON with the electrical parking switch is pressed.
- The electric tailgate is completely open.
- People, luggage, etc., are not touching the sensors.

Electric tailgate*

Operating the electric tailgate using the keyless operation key or the driver's side electric tailgate switch

4

After unlocking the doors and the electric tailgate, the electric tailgate can be operated by pressing the switch (A) of the keyless operation key or the driver's side electric tailgate switch (B).

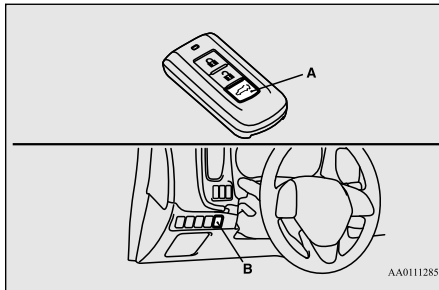

<Using the keyless operation key>

If the electric tailgate switch is pressed twice in a row, the electric tailgate operates after the warning buzzer sounds and the hazard warning flasher blinks 2 times.

The electric tailgate operates as follows:

- While closed: The warning buzzer sounds 4 times and the tailgate completely opens.
- While open: The warning buzzer sounds 3 times and the tailgate completely closes.

If the electric tailgate switch is pressed once while the tailgate is operating, the warning buzzer sounds once and it moves in the direction opposite to the one in which it was operating.

NOTE

- If the electric tailgate switch is pressed 3 or more times in a row, the tailgate may not operate normally. If this occurs, wait a short time before again pressing the electric tailgate switch twice.

<Using the driver's side electric tailgate switch>

If the driver's side electric tailgate switch is pressed for more than about 1 second, the electric tailgate operates after the buzzer sounds and the hazard warning flasher blinks 2 times.

The electric tailgate operates as follows.

- While closed: The warning buzzer sounds 4 times and the tailgate completely opens.
- While open: The warning buzzer sounds 3 times and the tailgate completely closes.

If the driver's side electric tailgate switch is pressed once while the tailgate is operating, the warning buzzer sounds once and it moves in the direction opposite to the one in which it was operating.

WARNING

- When operating the electric tailgate, ensure the safety of the surrounding area, make sure there is sufficient space behind and above the vehicle, and be careful not to bump your head or catch your hands or fingers.

Opening the electric tailgate using the open switch

The electric tailgate can be opened by pressing the open switch (C).

Electric tailgate*

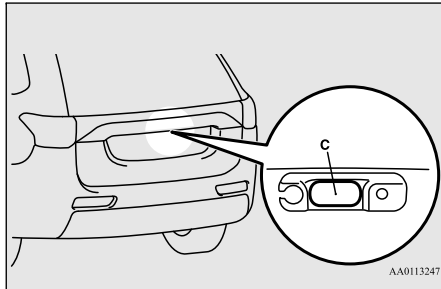

If the open switch is pressed with the tailgate and all doors are unlocked, the electric tailgate opens after the warning buzzer sounds 4 times and the hazard warning flasher brinks 2 times.

When the tailgate and all doors are locked, the warning buzzer will not sound.

NOTE

- When you are carrying the keyless operation key with the tailgate is locked, the electric tailgate can be opened by pressing the open switch even if the tailgate is locked. The factory setting of the function is “Inactive”. To modify the setting to “Active”, please contact an authorised MITSUBISHI MOTORS dealer.

Closing the electric tailgate using the close switch

The electric tailgate can be closed by pressing the close switch (D) on the inside of the electric tailgate.

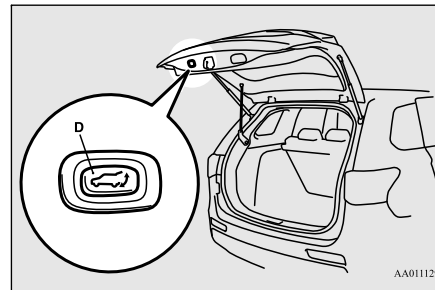

If the close switch on the inside of the electric tailgate is pressed, the electric tailgate closes after the warning buzzer sounds 3 times and the hazard warning flasher brinks 2 times.

If the close switch is pressed once while the tailgate is closing, the warning buzzer sounds once and the electric tailgate opens.

NOTE

- If the close switch is again pressed once while the electric tailgate is operating in the opening direction, the warning buzzer sounds once and the electric tailgate closes.

Safety mechanism

E00313200013

The safety mechanism is activated if the electric tailgate should trap a person or an object during automatic operation, or if the sensors (A) on either side of the electric tailgate are hit. The warning buzzer sounds once for safety and the electric tailgate automatically moves in the direction opposite to the one in which it was operating.

4

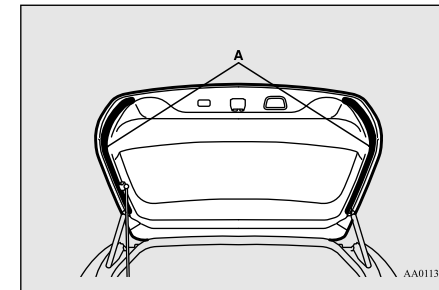

CAUTION

- The safety mechanism will sometimes not operate depending on the condition of the trapped object or how it is trapped. Therefore, be especially careful not to trap a hand, part of your body or an object at this time.

Electric tailgate*

4

CAUTION

- The safety mechanism is cancelled just before the electric tailgate is fully closed to allow it to close completely. Therefore be especially careful not to trap a hand or finger at this time.
- The safety mechanism is deactivated when the electric tailgate is closed manually. Therefore be especially careful not to trap a hand or finger at this time.
- If the safety mechanism is repeatedly operated, the tailgate could be switched to manual operation. Be careful at this time, as the electric tailgate could open or close suddenly, depending on its position. Once the electric tailgate is completely open or closed, normal automatic operation is again possible.

NOTE

- If the environment or usage conditions subject the sensors to the same kind of force as that of trapping a person or object, the safety mechanism could be activated.
- Do not damage the sensors when loading or unloading luggage, or when cleaning the rear window. Doing so could prevent the tailgate from closing automatically.

Drop prevention mechanism

After the electric tailgate is opened automatically, if it is detected that the tailgate is dropping due to factors such as accumulated snow, the electric tailgate is closed automatically.

A warning buzzer sounds continuously while the drop prevention mechanism operates.

NOTE

- If snow has accumulated on the electric tailgate, remove it before operation.
- Do not install accessories other than MITSUBISHI MOTORS GENUINE parts on the electric tailgate. Some accessories could be too heavy, causing the drop prevention mechanism to operate.
- The drop prevention mechanism could be activated if manual operation is attempted immediately after the electric tailgate is completely opened automatically.

Sudden operation prevention mechanism

If the engine is started while the electric tailgate is operating automatically, it may switch to manual operation due to insufficient battery voltage, making the electric tailgate stop intermittently while it moves. This is to stop

the electric tailgate from operating suddenly. When the tailgate is completely closed or opened, automatic operation is again possible after approximately 10 seconds.

CAUTION

- The safety mechanism is deactivated while the sudden operation prevention mechanism is operating. Therefore be especially careful not to trap a hand or finger at this time.

Manual operation

E00313400015

If the electric tailgate power switch is off, the electric tailgate can be operated by manual operation.

After unlocking the electric tailgate, push the tailgate open switch (A) and pull up the tailgate.

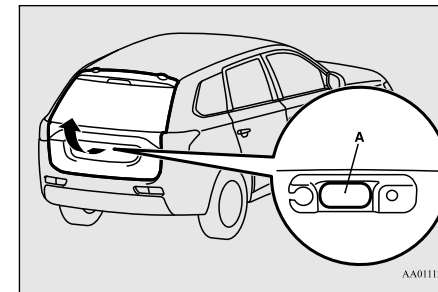

Electric tailgate*

CAUTION

- Make sure there is no one around the electric tailgate when opening it.

NOTE

- If it does not open immediately after pushing the tailgate open switch, the electric tailgate cannot be lifted.
If this occurs, push the tailgate open switch again and pull up the electric tailgate.
- The electric tailgate cannot be opened when the battery is flat or disconnected.

To close the tailgate, pull the tailgate grip (B) downward and release it before the tailgate is completely closed, and then gently slam the electric tailgate from the outside.

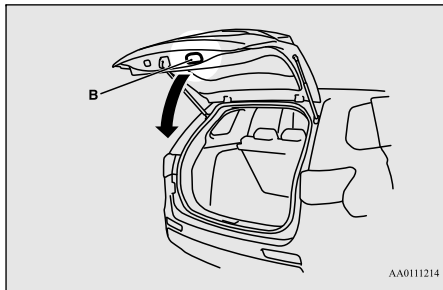

CAUTION

- Do not fully close the electric tailgate with your hand still on the tailgate grip. Doing so could trap and injure your hand or arm.
- The safety mechanism is deactivated when the electric tailgate is closed manually. Therefore be especially careful not to trap a hand or finger at this time.

Tailgate easy closer

E00313300014

The tailgate easy closer is a mechanism for assisting the closing of the electric tailgate. If the electric tailgate is closed to a position where it is detected as being ajar, it closes automatically.

WARNING

- Be careful not to catch your hands or fingers when the electric tailgate closes automatically from the door ajar position. If you think your hands or fingers could be caught during the operation of the tailgate easy closer, pull the handle of the electric tailgate. The electric tailgate will return to the door ajar position.

CAUTION

- Do not touch the latch (A) on the inside of the electric tailgate. The tailgate easy closer could operate and catch your fingers.

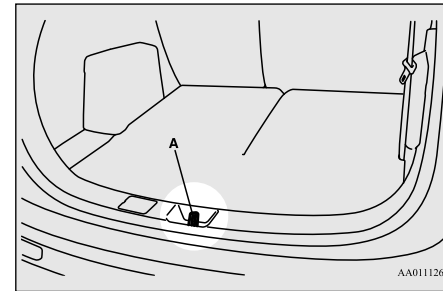

NOTE

- The tailgate easy closer operates even when the electric tailgate power switch is OFF.
- Repeated continuous operation of the handle could activate the protection circuit and temporarily prevent the tailgate easy closer from operating.
If this occurs, wait about 1 minute before operating the tailgate easy closer again.

4

Inside tailgate release

Inside tailgate release

E00303400298

The inside tailgate release is designed to provide a way to open the tailgate in the case of a discharged battery.

4

The tailgate release (see illustration) is mounted on the tailgate.

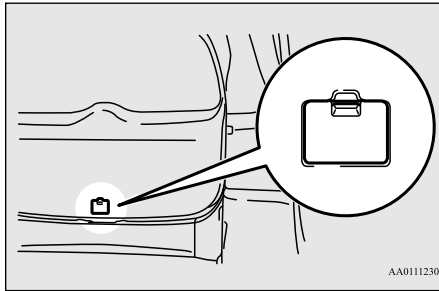

You and your family should familiarise yourselves with the location and operation of the tailgate release.

To open

1. Open the lid (A) inside of the tailgate.

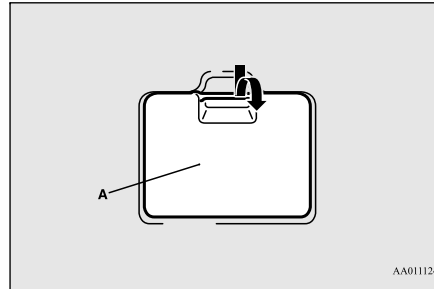

2. Move the lever (B) to open the tailgate.

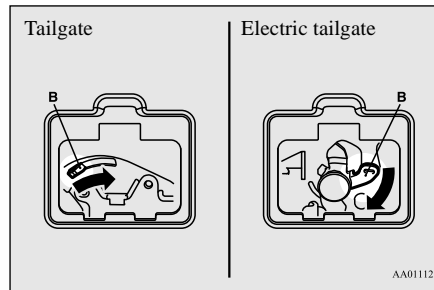

3. Push out on the tailgate to open it.

CAUTION

- Always keep the release lever lid on tailgate closed when driving so that your luggage cannot accidentally bump the lever and open the tailgate.

Security alarm system*

E00301501973

The security alarm system is for alerting the surrounding area of suspicious behaviour to prevent unlawful entry into the vehicle by operating an alarm if a door, the tailgate or the bonnet is opened when the vehicle has not been unlocked using the keyless entry system or the keyless operation function.

CAUTION

- Do not modify or add parts to the security alarm system. Doing so could cause the security alarm to malfunction.

NOTE

- The alarm system will not be activated if the doors and the tailgate have been locked using a key, the central door lock switch (instead of the keyless entry system or the keyless operation function).

Security alarm system*

NOTE

- If the turn-signal lamps do not blink after the locking and unlocking operation using the keyless entry system or the keyless operation function, the security alarm system may be malfunctioning.

Have the vehicle inspected at a MITSUBISHI MOTORS Authorised Service Point.

If the confirmation function (blinking of the turn-signal lamps by locking and unlocking the doors and the tailgate) is deactivated, the turn-signal lamps do not blink after the locking and unlocking operation.

For information on the confirmation function, refer to “Keyless entry system” on pages 4-3 and “To operate using the keyless operation function” on page 4-9.

- The security alarm system could be activated in the following situations.
 - Using a car washer
 - Taking the vehicle on a ferry
 - Parking in an automated car park
 - Leaving someone or a pet in the vehicle
 - Leaving a window or the sunroof open
 - Leaving an unstable object such as a stuffed toy or accessory in the vehicle
 - Suffering a continuous impact or vibration by hail, thunder, etc.

NOTE

- Air flows by the Remote Climate Control. According to the situations, please deactivate the vehicle inclination detection function and the interior intrusion detection function. Refer to “To deactivate the vehicle inclination detection function and the interior intrusion detection function” on page 4-27.
- The sensitivity of the interior intrusion detection function can be adjusted. For further details, please contact a MITSUBISHI MOTORS Authorised Service Point.

The security alarm has four modes:**System preparation mode (approx. 20 seconds)**

(The buzzer sounds intermittently and the security indicator (A) blinks.)

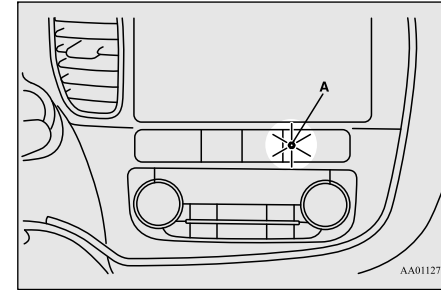
**4**

The system preparation time extends from the point at which all of the doors and the tailgate are locked by pressing of the LOCK switch on the remote control switch or the keyless operation function to the point at which the system armed mode goes into effect.

During this time, it is possible to temporarily open a door or the tailgate without using the keyless entry system or the keyless operation function and without causing the alarm to sound (for example, when you forget something inside the vehicle or realize that a window is open).

System armed mode

(The buzzer stops and the security indicator continues to blink with the indicator's reduced lit-up duration time.)

Once the system preparation mode has ended, the system armed mode starts.

Locking and unlocking 4-25

Security alarm system*

If an unlawful opening of any of the doors, tailgate or bonnet is detected during the system armed mode, the alarm will be activated to warn people around the vehicle of an abnormal condition.

4

Alarm activation

Inside alarm (approx. 10 seconds):

The buzzer sounds, warning those inside the vehicle of an abnormal condition. (except for vehicles equipped with the interior alarm sensor)

Outside alarm (approx. 30 seconds):

The turn-signal lamps blink and the horn (the siren for vehicles equipped with the interior alarm sensor) sounds, warning people around the vehicle of an abnormal condition.

Refer to “Alarm activation” on page 4-28.

NOTE

- The alarm will resume if unlawful actions are taken again, even if the alarm has stopped.

System cancellation

It is possible to cancel the system activation during the system preparation mode or the system armed mode.

In addition, it is possible to cancel the alarm once it has been activated.

Refer to “Cancelling the system” on page 4-28, “Cancelling the alarm” on page 4-29.

NOTE

- When lending the vehicle to another person or allowing the vehicle to be driven by someone who is unfamiliar with the security alarm system, be sure to give the person a proper explanation of the security alarm system.
If a person who is unfamiliar with the security alarm system accidentally unlocked the vehicle, causing the alarm to sound, the alarm would be a nuisance to people nearby.

Setting the system

E00301701988

Follow the procedure below to set the system to the system armed mode.

1. Put the operation mode in OFF.
2. Exit the vehicle and close all of the doors, tailgate and bonnet.

3. Press the LOCK switch (A) on the remote control switch of the keyless operation key, the driver’s or front passenger’s door lock/unlock switch (B), or the tailgate LOCK switch (C) in order to lock all the doors and the tailgate.

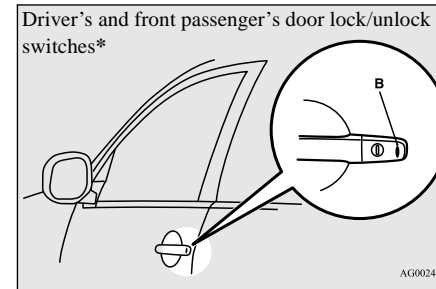
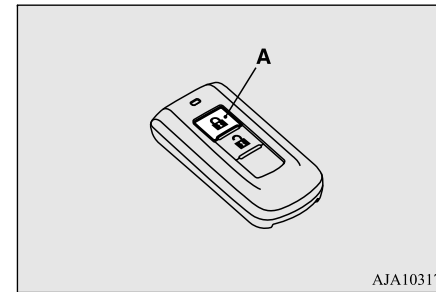

Security alarm system*

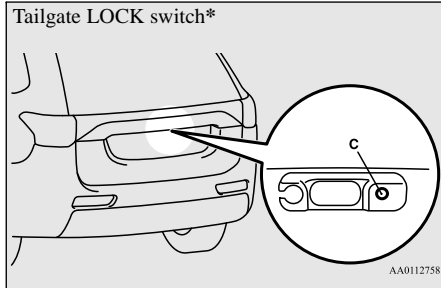

By locking the vehicle using the keyless entry system or the keyless operation function, the system preparation mode is activated.

The buzzer makes an intermittent beeping sound and the security indicator (D) in the centre panel flashes for confirmation.

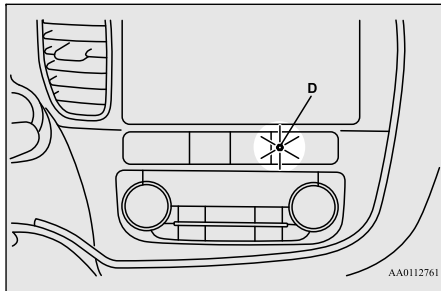

NOTE

- The system preparation mode is not activated when the doors and the tailgate have been locked using a method other than the keyless entry system or the keyless operation function (namely a key, the inside lock knob or the central door lock switch).
- If the bonnet is open, the security indicator illuminates, and the system does not enter the system preparation mode. When the bonnet is closed, the system enters the system preparation mode, and after about 20 seconds the system enters the system armed mode.

4. After approximately 20 seconds, the buzzer stops, and when the blinking of the security indicator starts to slow down, the system armed mode goes into effect.

The security indicator continues to blink during the system armed mode.

NOTE

- The security alarm system can be activated when people are riding inside the vehicle or when the windows are open. To prevent accidental activation of the alarm, do not set the system to the system armed mode while people are riding in the vehicle.
- Avoid leaving valuable items inside the vehicle even when the security alarm system has been set to the “active” mode.

To deactivate the vehicle inclination detection function and the interior intrusion detection function

E00312101416

4

The vehicle inclination detection function and the interior intrusion detection function can be deactivated when parking in automated car parks or leaving pets in the vehicle or leaving the vehicle with the windows slightly open.

1. Put the operation mode in OFF.
2. Raise and hold the wiper and washer switch to the “MIST” position for about 3 seconds. The buzzer will sound once and the function will be deactivated.

To activate the function again, raise and hold the wiper and washer switch to the “MIST” position for about 3 seconds.

The buzzer will sound twice and the function will be activated.

Security alarm system*

4

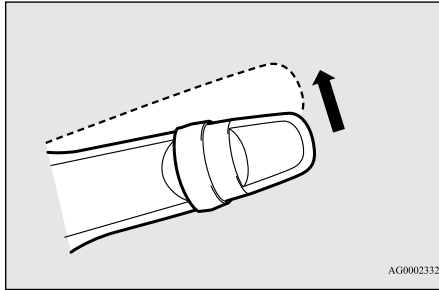

NOTE

The function will be activated again if the following operation is performed.

- If the doors and the tailgate are unlocked using the keyless entry system or the keyless operation function.
- If the operation mode is put in on or ACC.

Cancelling the system

E00301801859

The following methods can be used to cancel the system when it is in the system preparation mode or the system armed mode.

- Pressing the UNLOCK switch on the remote control switch.
- Putting the operation mode in ON.
- Opening any one of the doors or the tailgate, when the system is in the system preparation mode.

4-28 Locking and unlocking

- Holding the keyless operation key and pressing the driver's or front passenger's door lock/unlock switch, or the tailgate open switch to unlock the doors and the tailgate.

NOTE

- If the bonnet is opened during the system preparation mode, the system preparation mode is suspended.
The system returns to the system preparation mode when the bonnet is closed.
- If the battery terminals are disconnected while the system is in the system preparation mode, the memory will be erased.
- It is possible to register up to 4 remote control switches.
As long as they are registered, any of the remote control switches, other than the one used to activate the system, can be used to cancel the system.

If you want to register additional remote control switches, please contact a MITSUBISHI MOTORS Authorised Service Point.

- The activation distance for keyless entry system is approximately 4 m.
If it is not possible to lock or unlock the vehicle by pressing the switch at the correct distance or the security alarm system cannot be set or cancelled using the switch, the battery may need to be replaced.
Replace the battery at a MITSUBISHI MOTORS Authorised Service Point.

NOTE

- If the UNLOCK switch on the remote control switch, or the driver's or front passenger's door lock/unlock switch is pressed and no door or the tailgate is opened within 30 seconds, the doors and the tailgate will automatically relock. In this case as well, the system preparation mode will go into effect.
- The time between pressing of the UNLOCK switch on the remote control switch, or the driver's or front passenger's door lock/unlock switch and automatic locking can be adjusted. Please consult a MITSUBISHI MOTORS Authorised Service Point.
On vehicles equipped with Mitsubishi Multi-Communication System (MMCS), screen operations can be used to make the adjustment. Refer to the separate owner's manual for details.

Alarm activation

E00301902118

When the system is in the system armed mode, the alarm will be activated as follows if the vehicle is unlocked or if any of the doors, tailgate or bonnet is opened using a method other than the keyless entry system or the keyless operation function.

Electric window control

1. The inside alarm will be activated for approximately 10 seconds. (except for vehicles equipped with the interior alarm sensor)

NOTE

- If the bonnet is opened during the system armed mode, the vehicle outside alarm operates immediately.

2. The alarm will be activated for approximately 30 seconds.

The turn-signal lamps will flash, and the horn (the siren for vehicles equipped with the interior alarm sensor) will sound intermittently.

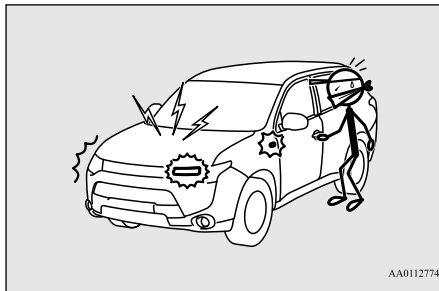

3. The alarm will resume if unlawful actions are taken again, even if the alarm has stopped.

Cancelling the alarm

E00302001698

It is possible to halt the activation of an alarm using the following methods:

- Pressing the LOCK or UNLOCK switch on the remote control switch. (After pressing of the LOCK switch, the vehicle will lock if all the doors and the tailgate are closed, after which the system preparation mode will once again go into effect.)
- Putting the operation mode in ON.
- Holding the keyless operation key and locking or unlocking the doors and the tailgate using the keyless operation function.

NOTE

- When the ignition switch is turned to the "ON" position or the operation mode is put in ON, the buzzer sounds 4 times. This operation indicates that the alarm was activated while the vehicle was parked. Please check the inside of the vehicle to confirm that nothing was stolen.
- Even if the battery is disconnected, the alarm activation memory will not be erased.

Electric window control

E00302201632

The electric windows can only be operated with the operation mode in ON.

Electric window control switch

E00302301822

Each door window opens or closes while the corresponding switch is operated.

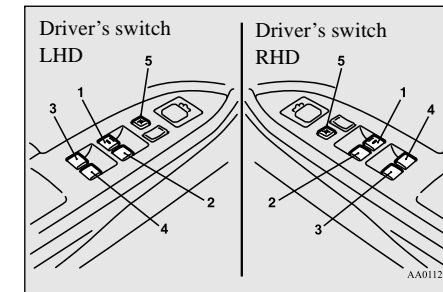

- 1- Driver's door window
- 2- Front passenger's door window
- 3- Rear left door window
- 4- Rear right door window
- 5- Lock switch

Electric window control

4

WARNING

- Before operating the electric window control, make sure that nothing is capable of being trapped (head, hand, finger, etc.).
- Never leave the vehicle without removing the key.
- Never leave a child (or other person who might not be capable of safe operation of the electric window control) in the vehicle alone.

Driver's switches

The driver's switches can be used to operate all door windows. A window can be opened or closed by operating the corresponding switch.

Press the switch down to open the window, and pull up the switch to close it.

If the switch for the driver's window is fully pressed down/pulled up, the door window automatically opens/closes completely.

If you want to stop the window movement, operate the switch lightly in the reverse direction.

Passenger's switches

The passenger's switches can be used to operate the corresponding passenger's door windows.

Press the switch down for opening the window, and pull up the switch for closing.

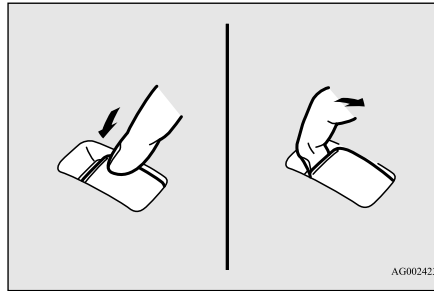

AG0024231

NOTE

- Repeated operation with the engine stopped will run down the battery. Operate the window switches only while the engine is running.
- The rear door windows only open halfway.

Lock switch

E00303101263

When this switch is operated, the passenger's switches cannot be used to open or close the

door windows and the driver's switch cannot open or close any door windows other than the driver's door window.

To unlock, press it once again.

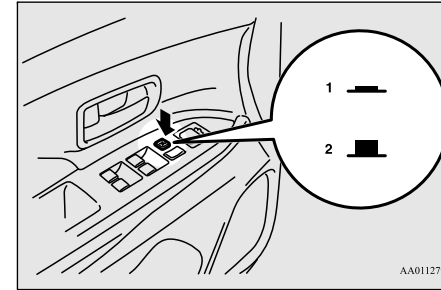

AA0112790

- 1- Lock
- 2- Unlock

WARNING

- A child may tamper with the switch at the risk of its hands or head being trapped in the window. When driving with a child in the vehicle, please press the window lock switch to disable the passenger's switches.

Timer function

E00302401012

The door windows can be opened or closed for 30 seconds after the engine is stopped.

However, once the driver's door or the front passenger's door is opened, the windows cannot be operated.

Safety mechanism (driver's window only)

E00302500830

If a hand or head is trapped in the closing window, it will lower automatically. Nonetheless, make sure that nobody puts their head or hand out of the window when closing the driver's door window. The lowered window will become operational after a few seconds.

⚠ WARNING

- If the battery terminals are disconnected or the fuse for electric window is replaced, the safety mechanism will be cancelled. If a hand or head got trapped, a serious injury could result.

⚠ CAUTION

- The safety mechanism is cancelled just before the window is fully closed. This allows the window to close completely. Therefore be especially careful that no fingers are trapped in the window.

⚠ CAUTION

- The safety mechanism is deactivated while the switch is pulled up. Therefore be especially careful that fingers are not trapped in the door window opening.

📖 NOTE

- The safety mechanism can be activated if the driving conditions or other circumstances cause the driver's door window to be subjected to a physical shock similar to that caused by a trapped hand or head.
- If the battery terminals are disconnected or the fuse for electric window is replaced, the safety mechanism will be cancelled and the door window will not automatically open/close completely. If the window is open, repeatedly raise the driver's door window switch until the window has been fully closed. Following this, release the switch, raise the switch once again and hold it in this condition for at least 1 second, then release it. You should now be able to operate the driver's door window in the normal fashion.

Sunroof*

E00302701275

The sunroof can only be operated with the ignition switch in the "ON" position.

Sunroof*

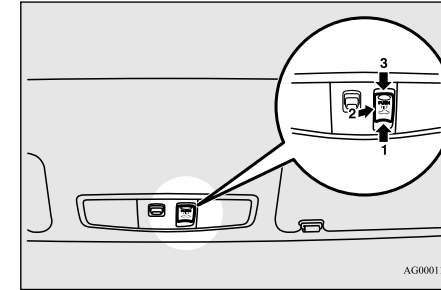

AG0001120

4

To open

The sunroof automatically opens if the switch (1) is pressed. To stop the moving sunroof, press the switch (2) or (3).

📖 NOTE

- The sunroof automatically stops just before reaching the fully open position. Press the switch again to make it open fully.

To close

The sunroof closes while the switch (3) is pressed.

Sunroof*

To tilt up

When the switch (2) is pressed, the rear edge of the sunroof rises for ventilation.

4

To tilt down

The sunroof tilts down while the switch (3) is pressed.

Timer function

E00303900349

The sunroof can be opened or closed for 30 seconds after the ignition switch is turned from the "ON" position to the "ACC" or "LOCK" position.

However, once the driver's door or the front passenger's door is opened, the sunroof cannot be operated.

⚠ WARNING

- Before operating the sunroof, make sure that nothing is capable of being trapped (head, hand, finger, etc.).
- Do not put head, hands or anything else out of the sunroof opening while driving the vehicle.
- Never leave the vehicle without removing the key.

⚠ WARNING

- Never leave a child (or other person who might not be capable of safe operation of the sunroof switch) in the vehicle alone.

📖 NOTE

- The sunroof stops just before reaching the fully open position.
If the vehicle is driven with the sunroof in this position, wind buffeting is lower than with the sunroof fully open.
- When leaving the vehicle unattended, make sure you close the sunroof and remove the ignition key.
- Do not try to operate the sunroof if it is frozen closed (after snow fall or during extreme cold).
- Do not sit or place heavy luggage on the sunroof or roof opening edge.
- Release the switch as soon as the sunroof reaches the fully open or fully closed position.
- If the sunroof does not operate when the sunroof switch is operated, release the switch and check whether something is trapped by the sunroof. If nothing is trapped, have the sunroof checked at an authorized MITSUBISHI MOTORS dealer.
- Depending on the models of ski carriers or roof carriers, the sunroof may contact the carrier when the sunroof is tilted up. Be careful when tilting up the sunroof if such a ski carrier or a roof carrier is installed.

📖 NOTE

- Be sure to close the sunroof completely when washing the vehicle or when leaving the vehicle.
- Be careful not to put any wax on the weatherstrip (black rubber) around the sunroof opening. If stained with wax, the weatherstrip cannot maintain a weatherproof seal with the sunroof.
- After washing the vehicle or after it has rained, wipe off any water that is on the sunroof before operating it.
- Operating the sunroof repeatedly with the engine stationary will run down the battery. Operate the sunroof while the engine is running.

Sunshade

E00304100029

Slide the sunshade manually to open and close it.

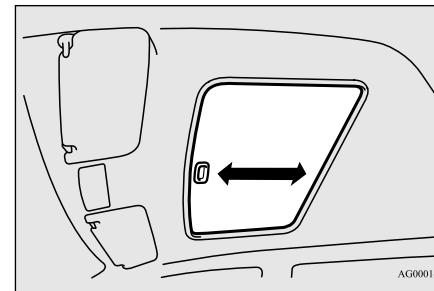

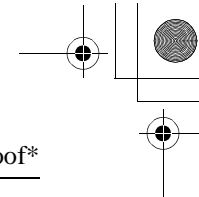
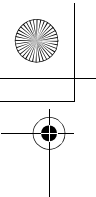

Sunroof*

CAUTION

- Be careful that hands are not trapped when closing the sunshade.

NOTE

- The sunshade cannot be closed with the sunroof opened. Do not attempt to close the sunshade when the sunroof is opened.

4

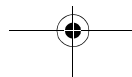
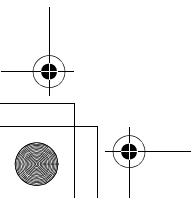
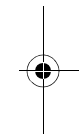
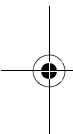

Locking and unlocking 4-33

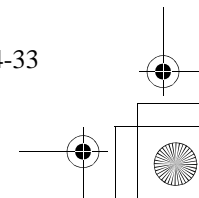

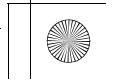
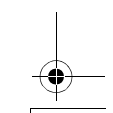
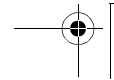
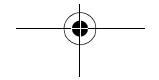
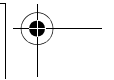
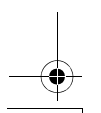
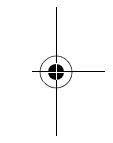
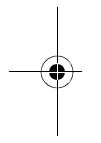
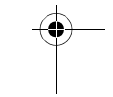
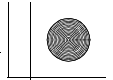
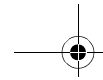
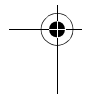
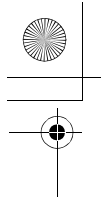

Handwriting practice area consisting of 10 horizontal dashed lines.

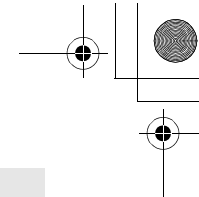
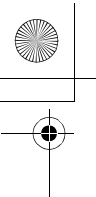

Seat and seat belts

Seat arrangement	5-2
Seat adjustment.....	5-2
Front seats.....	5-3
Rear seats	5-5
Head restraints	5-5
Making a luggage area.....	5-7
Making a flat seat.....	5-8
Seat belts.....	5-9
Pregnant women restraint	5-14
Seat belt pre-tensioner system and force limiter system	5-14
Child restraint	5-15
Seat belt inspection.....	5-21
Supplemental restraint system (SRS)-airbag.....	5-21

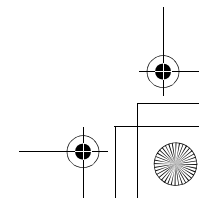
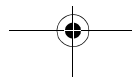
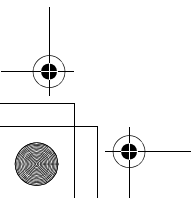
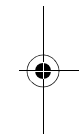
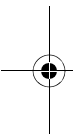

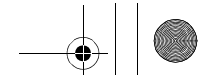



Seat arrangement

Seat arrangement

E00400201886

By operating the front or rear seat, select the desired seat arrangement.

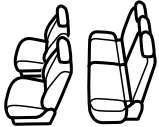
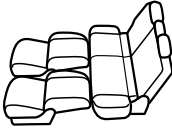
5

Normal usage	 <p>AGM000168</p>
Flat seat → P. 5-8	 <p>AGM000285</p>
Making a luggage area → P. 5-7	 <p>AAM008704</p>

Seat adjustment

E00400300675

Adjust the driver's seat so that you are comfortable and that you can reach the pedals, steering wheel, switches etc. while retaining a clear field of vision.

WARNING

- Do not attempt to adjust the seat while driving. This can cause loss of vehicle control and result in an accident. After adjustments are made, ensure the seating is locked in position by attempting to move the seat forward and rearward without using the adjusting mechanism.

5-2 Seat and seat belts

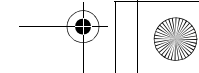
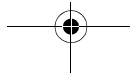

Front seats

⚠ WARNING

- **It is illegal to ride in the luggage area of a vehicle. Also, the luggage area and rear seats should never be used as a play area by children. In a collision, people riding unrestrained in these areas are more likely to be seriously injured or killed.**
Do not allow people or children to ride in any area of your vehicle that is not equipped with seats and seat belts, and make sure that everyone travelling in your vehicle is in a seat and wearing a seat belt, or in the case of a young child is strapped in a child restraint.
- **To minimize the risk of personal injury in the event of a collision or sudden braking, the seatbacks should always be in the almost upright position while the vehicle is in motion. The protection provided by the seat belts may be reduced significantly when the seatback is reclined. There is greater risk that the passenger will slide under the seat belt, resulting in serious injury, when the seatback is reclined.**

⚠ CAUTION

- The reclining mechanism of the front seat's seatback is spring loaded, causing it to return to the vertical position when the lock lever is operated. When using the lever, sit close to the seatback or hold it with your hand to control its return motion.
- When sliding the seats, be careful not to catch your hand or foot.
- When sliding or reclining the seat rearward, pay careful attention to the rear seat passengers.
- When adjusting the front seat while the rear seat is folded, be careful not to apply strong force to the flipped rear seat cushion. Doing so could cause damage to the cover of the front seat and the fitting of the rear seat cushion.

Front seats

E00400401266

Manual type

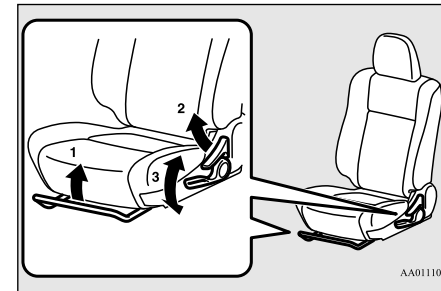

5

- 1- To adjust forward or backward
Lift the handle and adjust the seat to the desired position, and release the handle.
- 2- To recline the seatback
Pull the lever up and then lean backward to the desired position, and release the lever.
- 3- To adjust seat height (driver's side only)
Repeatedly operate the lever and adjust the seat height to the desired position.

⚠ CAUTION

- Make sure the seat is adjusted by an adult or with adult supervision for correct and safe operation.
- Do not place a cushion or the like between your back and the seatback while driving. The effectiveness of the head restraints will be reduced in the event of an accident.

Front seats

Power type*

5

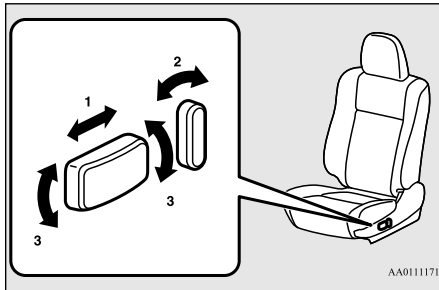

- 1- To adjust forward or backward
Operate the switch as indicated by the arrows and adjust the seat to the desired position.
- 2- To recline the seatback
Operate the switch as indicated by the arrows and adjust the seatback angle to the desired position.
- 3- To adjust seat height
Operate the switch as indicated by the arrows and adjust the seat height to the desired position.
If the entire switch is operated, then the entire seat moves.

Heated seats*

E00401102137

The heated seats can be operated with the operation mode of the power switch in ON. Operate the switch as indicated by arrows. The indication lamp (A) will illuminate while the heater is on.

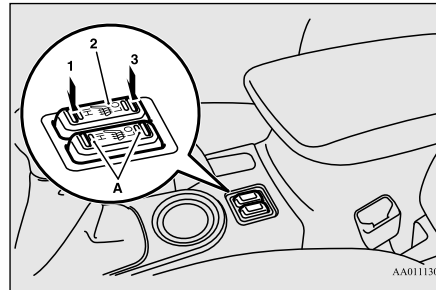

- 1 (HI) - Heater high (for quick heating).
- 2 - Heater off.
- 3 (LO) - Heater low (to keep the seat warm).

CAUTION

- Operate in the “HI” position for quick heating. Once the seat is warm, set the heater switch to the “LO” position to keep it warm. Slight variations in seat temperature may be felt while using the heated seats. This is caused by the operation of the heater’s internal thermostat and does not indicate a malfunction.
- If the following types of persons use the heated seats, they might become too hot or receive minor burns (red skin, heat blisters, etc.):
 - Children, elderly or ill people
 - People with sensitive skin
 - Excessively tired people
 - People under the influence of alcohol or sleep inducing medication (cold medicine, etc.)
- Do not place heavy objects on the seat or stick pins, needles, or other pointed objects into it.
- Do not use a blanket, cushion, or other material with high heat insulation properties on the seat while using the heater; this might cause the heater element to overheat.
- Do not use benzine, kerosene, petrol, alcohol or other organic solvents when cleaning the seats. Doing so could damage not only the seat cover, but also the heater element.

5-4 Seat and seat belts

Rear seats

CAUTION

- If water or any other liquid is spilled on the seat, allow it to dry thoroughly before attempting to use the heater. Turn the heater off immediately if it appears to be malfunctioning during use.

Rear seats

E00401301451

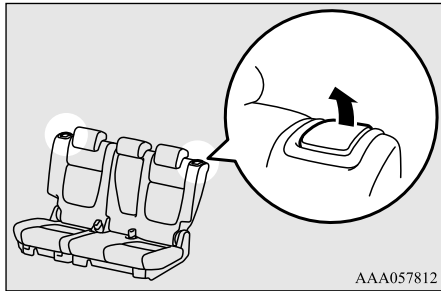

AAA057812

To adjust the seatback, pull the lever up and adjust the seatback by hand to the desired position, and release the lever.

Armrest

E00401701732

To use the armrest, fold it down. To return to the original position, push it backward until it is flush with the seat.

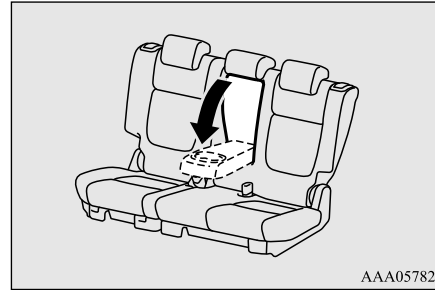

AAA057825

NOTE

- Do not climb or sit on the armrest. Doing so could damage the armrest.
- The top surface of the armrest contains a cup holder for rear seat occupants. Refer to "Cup holder" on page 8-70.

Head restraints

E00403302654

WARNING

- Driving without the head restraints in place can cause you and your passengers serious injury or death in an accident. To reduce the risk of injury in an accident, always make sure the head restraints are installed and properly positioned when the seat is occupied.

WARNING

- Never place a cushion or similar device on the seatback. This can adversely affect head restraint performance by increasing the distance between your head and the restraint.
- When a person sits in the rear seats, pull up the head restraint to a height at which it locks in position. Be sure to make this adjustment before starting to drive. Serious injuries could otherwise be suffered in the result of an impact.

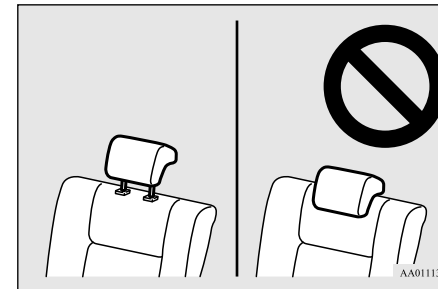

AA011357

To adjust height

Adjust the head restraint height so that the centre of the head restraint is as close as possible to ear level to reduce the chances of injury in the event of collision. Any person too tall for the head restraint to reach their

Head restraints

seated ear level, should adjust the restraint as high as possible.

To raise the head restraint, move it upward.
To lower the restraint, move it downward while pushing the height adjusting knob (A) in the direction of the arrow. After adjustment, push the head restraint downward and make sure that it is locked.

5

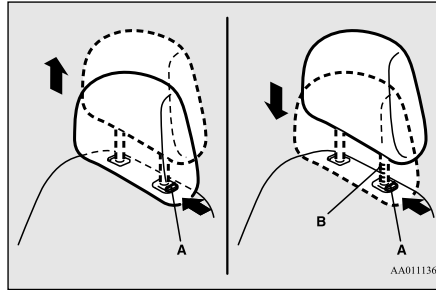
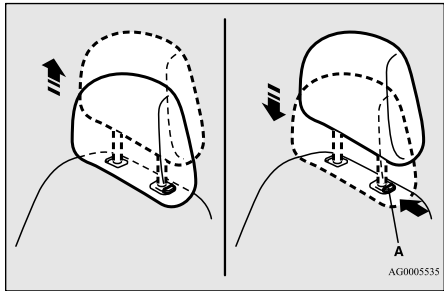

To install

Confirm that the head restraint is facing the correct direction, and then insert it into the seatback while pressing the height adjusting knob (A) in the direction indicated by the arrow.

The head restraint stalk with the adjustment notches (B) must be installed in the hole with the adjusting knob (A).

CAUTION

- Confirm that the height adjusting knob (A) is correctly adjusted as shown in the illustration, and also lift the head restraints to ensure that they do not come out of the seatback.

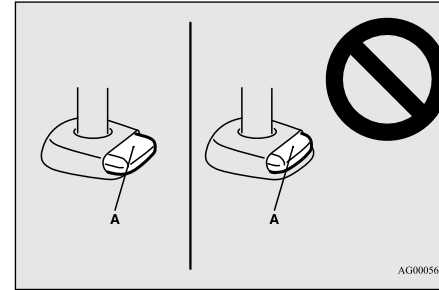

CAUTION

- The shape and size of the head restraint differs according to the seat. Always use the correct head restraint provided for the seat and do not install the head restraint in the wrong direction.

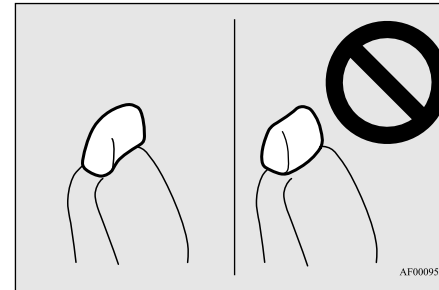

5-6 Seat and seat belts

Making a luggage area

E00403401371

To create luggage space, you can fold the rear seats.

CAUTION

- Do not stack luggage above the seatback height. Secure the luggage firmly. Serious accidents could result due to unrestrained objects entering the passenger compartment during sudden braking.
- When folding the seat, be sure not to catch your hand or leg.

NOTE

- It is possible to fold the seat independently on each side.

To fold

1. Lower the head restraints of the rear seat to the lowest position.
Refer to “Head restraints” on page 5-5.
2. Store the seat belt for the rear centre seating position.
Refer to “Rear-centre 3-point type seat belt” on page 5-12.

3. Lift the front end of the seat cushion.

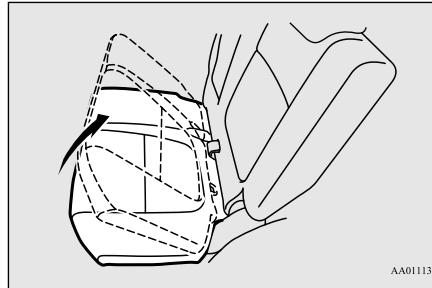

4. Flip the seat cushion forward.

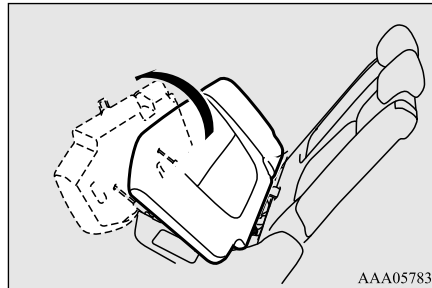

5. Fold the seat belt buckles forward.

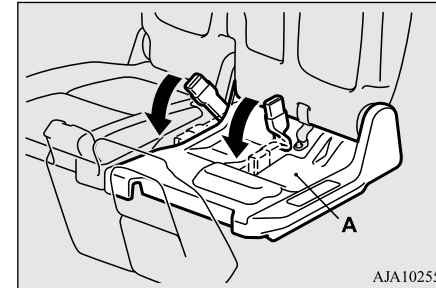

CAUTION

- Do not allow any person to get on the plastic cover (A), and do not place luggage on it. Doing so could damage cover.

6. Pull up the lever, then fold the seatback forward.

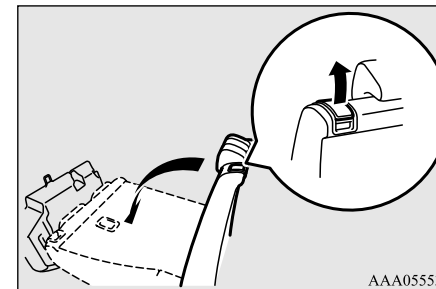

5

Making a flat seat

⚠ CAUTION

- Do not allow any person to sit on the flipped seat cushion, and do not place luggage on it. The seat's mounting fittings could bend under the weight, making it impossible for the seat to be retained on the vehicle.

5

To return

1. Raise the seatback until it locks securely into place.

2. While lifting the seat belt's buckle (A), gently lower the seat cushion. Make sure that there is a hook (B) at the position shown in the illustration.

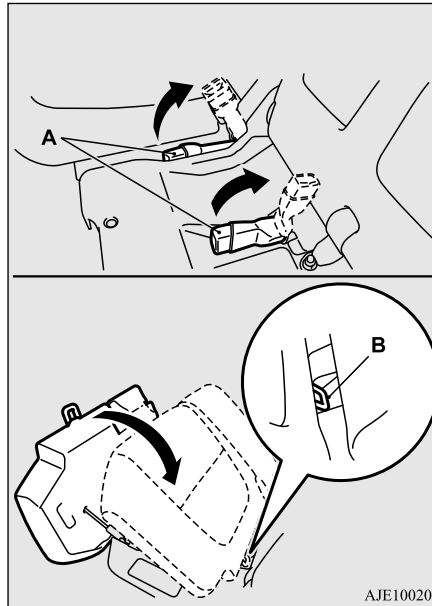

3. Push down the seat cushion until it locks into place.

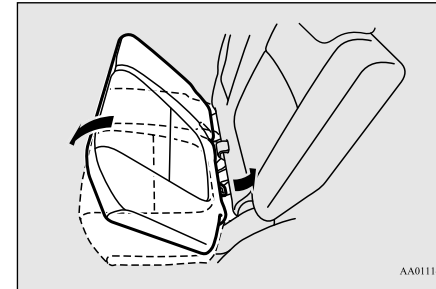

4. Make sure the seat belt's buckle is on the seat cushion.

Making a flat seat

E00404301931

By removing the head restraints and fully reclining the seatbacks of the seats, one large flat seat is achieved.

⚠ WARNING

- Never drive with passengers on the flat seat. This is highly dangerous.

⚠ CAUTION

- To make a flat seat, stop the vehicle in a safe place.

Seat belts

CAUTION

- Make sure the seat is adjusted by an adult or with adult supervision for correct and safe operation.
- Do not walk around on top of the seats after they have been laid flat.
- To ensure the seats are locked securely, attempt to move them back and forth.
- Do not jump on, or impact the seatbacks heavily.
- To raise the seatback, put a hand on the seatback and raise slowly. Never have a child do this operation, or an unexpected accident may result.

1. Remove the head restraints from the front seats, raise the armrest and remove the cargo area cover.
(Refer to “Head restraints” on page 5-5, “Armrest” on page 5-5 and “Cargo area cover” on page 8-71)

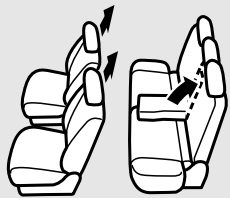

2. Slide the front seats fully forward, then recline the seatbacks backwards to achieve a flat surface.
(Refer to “Front seats” on page 5-3)

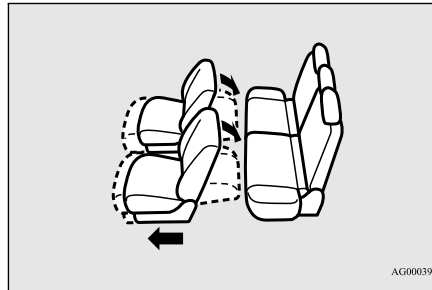

3. Recline the rear seatbacks backwards.
(Refer to “Rear seats” on page 5-5)

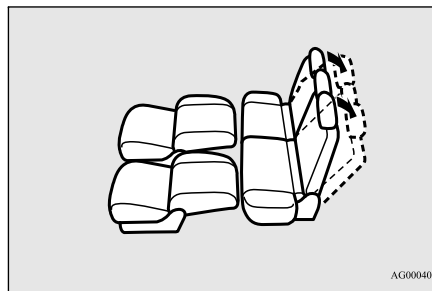

4. The flat seat configuration is now complete. Reverse the above procedures when returning the seat to the normal position.

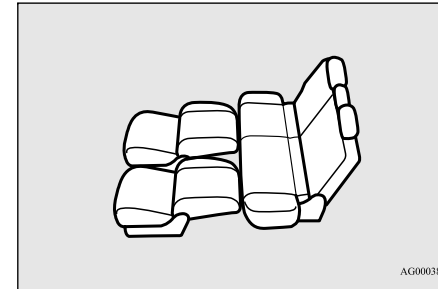

5

Seat belts

E00404800867

To protect you and your passengers in the event of an accident, it is the most important that the seat belts be worn correctly while you drive.

The front seat belts have a pre-tensioner system. These belts are used the same way as a conventional seat belt.

Refer to “Seat belt pre-tensioner system and force limiter system” on page 5-14.

Seat belts

5

⚠ WARNING

- Seat belts should always be worn by every adult who drives or rides in this vehicle, and by all children who are large enough to wear seat belts properly. Other children should always use proper child restraint systems.
- Always place the shoulder belt over your shoulder and across your chest. Never put it behind you or under your arm.
- One seat belt should be used by only one person. Doing otherwise can be dangerous.
- The seat belt will provide its wearer with maximum protection if the recliner seatback is placed in fully upright position. When the seatback is reclined, there is greater risk that the passenger will slide under the belt, especially in a forward impact accident, and may be injured by the belt or by striking the instrument panel or seatbacks.
- Remove any twists when using the belt.
- No modifications or additions should be made by the user which will either prevent the seat belt adjusting devices from operating to remove slack, or prevent the seat belt assembly from being adjusted to remove slack.
- Never hold a child in your arms or on your lap when riding in this vehicle, even if you are wearing your seat belt. To do so risks severe or fatal injury to your child in a collision or sudden stop.

⚠ WARNING

- Always adjust the belt to a snug fit.
- Always wear the lap portion of the belt over your hips.

3-point type seat belt (with emergency locking mechanism)

E00404902543

This type of belt requires no length adjustment. Once worn, the belt adjusts itself to the movement of wearer, but in the event of a sudden or strong shock, the belt automatically locks to hold the wearer's body.

📖 NOTE

- You can check if the belt locks by pulling it forward quickly.

To fasten

1. Pull the seat belt out slowly while holding the latch plate.

📖 NOTE

- When the seat belts cannot be pulled out in a locked condition, pull the belts once forcefully and then return them. After that, pull the belts out slowly once again.

2. Insert the latch plate into the buckle until a "click" is heard.

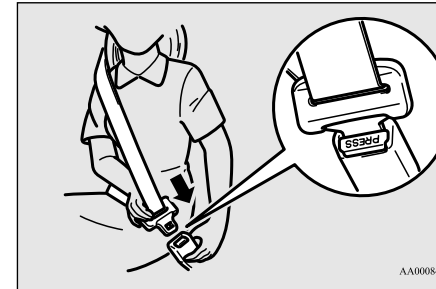
**⚠ WARNING**

- Never wear the lap portion of the belt across your abdomen. During accidents it can press sharply against abdomen and increase the risk of injury.
- The seat belts must not be twisted when worn.

3. Pull the belt slightly to adjust slackness as desired.

Seat belts

NOTE

- The seat belts in the rear seating outside positions are equipped with an automatic locking retractor (ALR) mechanism. If you pull the seat belt fully out of the retractor, the retractor will switch to its ALR child restraint installation mode and lock, thus preventing further movement. If this happens, you should switch the retractor back to its emergency locking retractor (ELR) mode by taking off the seat belt and fully rewinding it. You should then wear the seat belt again. (Refer to “Installing a child restraint system to a 3-point type seat belt (with emergency/automatic locking mechanism)” on page 5-18.)

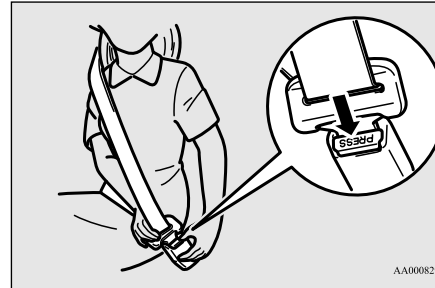

NOTE

- As the belt retracts automatically, keep the latch plate held while retracting so that the belt stows slowly. Failure to do this could damage the vehicle.

Seat belt reminder

E00409801960

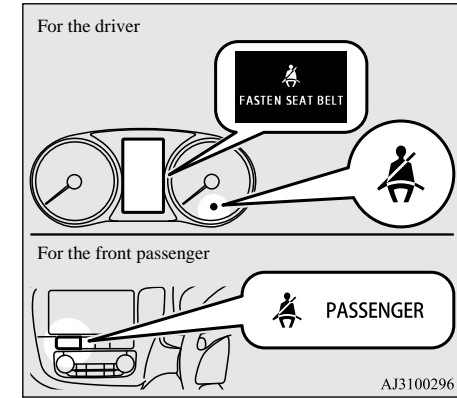

5

To unfasten

Hold the latch plate and push the button on the buckle.

If the operation mode of the power switch is put in ON while a seat belt is not fastened, the warning lamp comes on and the tone sounds for about 6 seconds to remind the driver and the front passenger to fasten the seat belt. If the vehicle is driven with the seat belt still unfastened, the warning lamp will blink and the tone will sound intermittently until the seat belt is fastened. At the same time, “FASTEN SEAT BELT” is displayed on the information screen in the multi information display for the driver.

Seat belts

⚠ WARNING

- Do not install any accessory or sticker that makes the lamp difficult to see.

📖 NOTE

- If the seat belt subsequently remains unfastened, the warning lamp and the tone will issue further warnings each time the vehicle starts moving from a stop.
- For the front passenger seat, the warning function works only while a person is sitting on the seat.
- When luggage is placed on the front passenger seat, a sensor in the seat cushion may, depending on the weight and position of the luggage, cause the warning tone to sound and the warning lamp to come on.

5

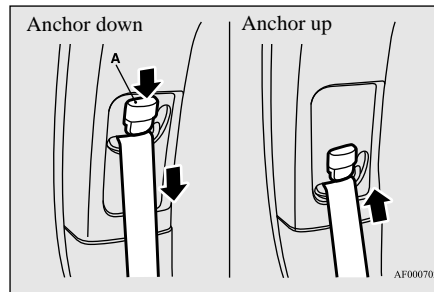

⚠ WARNING

- When adjusting the seat belt anchor, set it at a position that is sufficiently high so that the belt will make full contact with your shoulder but will not touch your neck.

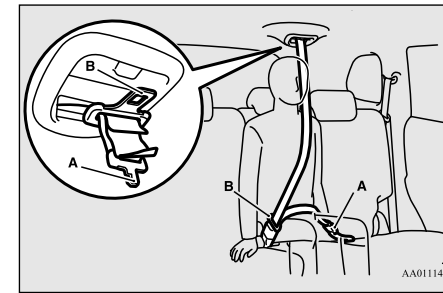

⚠ WARNING

- Be sure to securely connect the both latch plate (A and B). Failing to do so could significantly reduce the amount of protection and cause serious injuries in a collision or a sudden stop.

Adjustable seat belt anchor (front seats)

E00405000420

The seat belt anchor height can be adjusted. Move the seat belt anchor down with the lock knob (A) depressed. To move the anchor up, slide it without depressing the lock knob (A).

Rear-centre 3-point type seat belt

E00405201113

The rear-centre 3-point type seat belt must be worn correctly as illustrated.

To fasten

1. Pull out the buckle (C) from the seatback.
2. Pull the seat belt and insert the small latch plate (A) into the buckle (C).

Seat belts

3. Insert the latch plate (B) into the buckle (D).

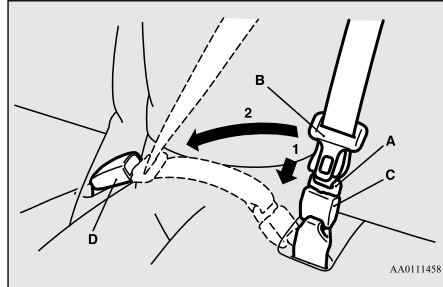

4. Pull the belt slightly to adjust slackness as desired.

To unfasten

1. Hold the latch plate and push the button on the buckle.

NOTE

- As the belt retracts automatically, keep the latch plate held while retracting so that the belt stows slowly. Failure to do this could damage the vehicle.
- To release the buckle (C), press the button (E) with a narrow-tipped object (latch plate or mechanical key etc.).

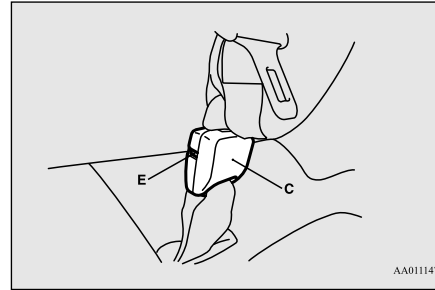

2. After the seat belt is retracted completely, insert the latch plate (B) into the upper slit (F), and then insert the small latch plate (A) into the lower slit (G).

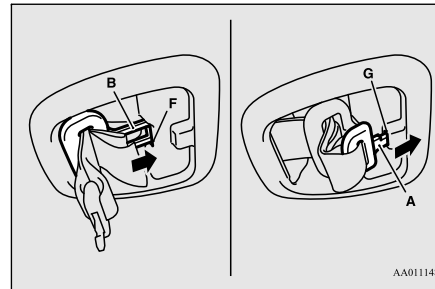

3. Store the seat belt buckle in the storage pocket. (Refer to next column.)

Rear seat belt storage

E00405301521

When the seat belt is not in use, store it as shown in the illustration.

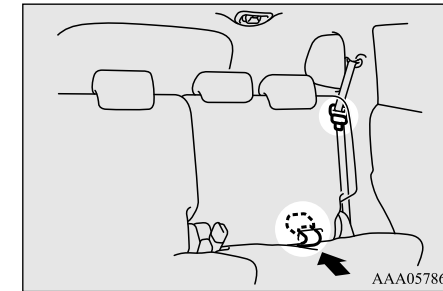

Seat belt plate storage

Outboard seating position

After passing the belt through the rear notch (A), insert the plate into the front notch (B).

Pregnant women restraint

5

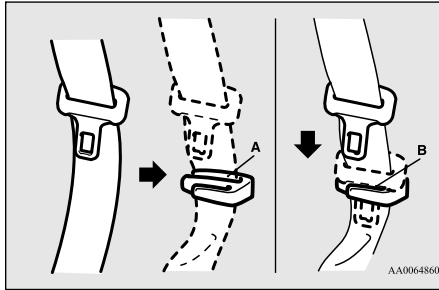

Pregnant women restraint

E00405600077

WARNING

- Seat belts work for everyone, including pregnant women. Pregnant women should use the available seat belts. This will reduce the likelihood of injury to both the woman and the unborn child. The lap belt should be worn across the thighs and as snug against the hips as possible, but not across the waist. Consult your doctor if you have any additional questions or concerns.

Seat belt pre-tensioner system and force limiter system

E00405701323

The driver's seat and front passenger's seat each have a seat belt equipped with a pre-tensioner system and force limiter system.

Pre-tensioner system

E00405802259

When the operation mode of the power switch is in ON, if there is a frontal impact or a side impact severe enough to injure the and/or front passenger, the pre-tensioner system will retract their respective seat belts instantaneously, thus maximizing the seat belt's effectiveness.

WARNING

- To obtain the best results from your pre-tensioner seat belt, make sure you have adjusted your seat correctly and wear your seat belt properly.

CAUTION

- Installation of audio equipment or repairs in the vicinity of the pre-tensioner seat belts or floor console must be performed in line with MITSUBISHI MOTORS guidelines. It is important to do so because the work could affect the pre-tensioner systems.

- If you need to scrap the vehicle, please consult a MITSUBISHI MOTORS Authorised Service Point.

It is important to do so because unexpected activation of the pre-tensioner seat belts could cause injuries.

NOTE

- The pre-tensioner seat belts will be activated if the vehicle suffers a severe impact, even if the seat belts are not worn.
- The pre-tensioner seat belts are designed to work only once. After the pre-tensioner seat belts have been activated, we recommend you have it replaced by a MITSUBISHI MOTORS Authorised Service Point.

SRS warning

E00405900360

The same warning lamp/display is shared by the SRS airbags and the pre-tensioner seat belts.

Refer to "SRS warning lamp/display" on page 5-30 .

Force limiter system

E0040600209

In the event of a collision, each force limiter system will effectively absorb the load applied to the seat belt to minimize the impact to the passenger.

Child restraint

E00406403145

When transporting children in your vehicle, an approved child restraint system should be used for each child (it is recommended).

⚠ WARNING

- When possible, put children in the rear seat. Accident statistics indicate that children of all sizes and ages are safer when properly restrained in the rear seat rather than in the front seat.
- Holding a child in your arms is no substitute for a restraint system. Failure to use a proper restraint system can result in severe or fatal injury to your child.
- Each child restraint device or fixing is to be used only by one child.
- When attaching a child restraint system to the rear seat, prevent the front seatbacks from touching the child restraint system. Otherwise, the child could be seriously injured in the event of hard braking or a collision.

Caution for installing the child restraint on vehicle with front passenger's airbag

The label shown here is attached on vehicles with front passenger's airbag.

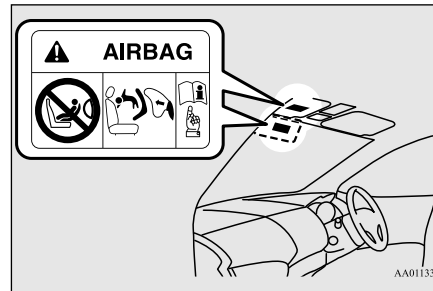

AA0113319

⚠ WARNING

- Extreme Hazard!
NEVER use a rearward facing child restraint on a seat protected by an ACTIVE AIRBAG in front of it, DEATH or SERIOUS INJURY to the CHILD can occur.

⚠ WARNING

- A REARWARD FACING CHILD RESTRAINT must NOT be used in the front passenger seat as it places an infant too close to the front passenger's airbag. The force of an inflating airbag could kill or cause serious injuries to the child. A rearward facing child restraint must only be used in the rear seat.

5

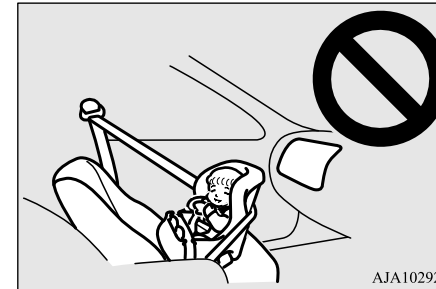

AJA102924

⚠ WARNING

- ALL CHILD RESTRAINTS should only be used in a seat with a top tether strap anchor point. Failure to use the top tether strap of a child restraint may kill or cause serious injuries to the child.

Child restraint

Infants and small children

E00406600465

For infants small enough for infants seats, use a Standards Association of Australia approved baby restraint. For small children whose height when seated allows the shoulder belt to lie in contact with the face or the throat, a child seat should be used.

5

WARNING

- The child restraint system should be appropriate for your child's weight and height and properly fit the vehicle. **THE CHILD RESTRAINT SYSTEM MUST BE INSTALLED IN THE REAR SEAT.**
- When installing a child restraint system, refer to the instructions provided by the manufacturer of the restraint system. Failure to do so can result in severe or fatal injury to your child.
- After installation, push and pull the child restraint system back and forth, and side to side, to see that it is positively secured. If the child restraint system is not installed securely, it may cause injury to the child or other occupants in the case of accident or sudden stops.
- When not in use, keep your child or infant seat secured with the seat belt or remove it from the vehicle in order to prevent injury to yourself or your passengers.

NOTE

- Before purchasing a child restraint system, try installing it in the rear seat to make sure there is a good fit. Because of the location of the seat belt buckles and the shape of the seat cushion, it may be difficult to securely install some manufacturer's child restraint systems. If the child restraint system can be pulled forward or to either side easily on the seat cushion after the seat belt has been tightened, choose another manufacturer's child restraint system.

Older children

E00406700307

Children who have outgrown the child restraint system should be seated in the rear seat and wear combination lap shoulder belt. The lap portion of the belt should be snug and positioned low on the abdomen so that it is below the top of the hip-bone. Otherwise, the belt could intrude into the child's abdomen during an accident and cause injury.

Child restraint anchorage points

E00406901931

When fitting a child restraint, always follow the manufacturer's instructions using the approved anchorage points shown.

For children too young to sit, use a Standards Association of Australia approved baby restraint. Be sure to comply with the laws of your state regarding restraining children in your vehicle.

Anchorage locations

There are 3 child restraint anchorage points located on the back of the rear seatbacks.

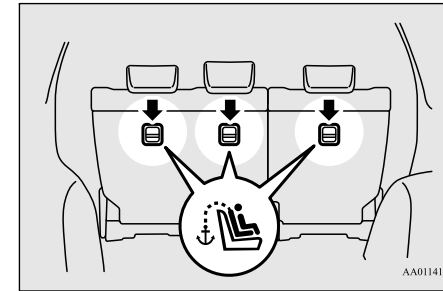

CAUTION

- The anchorages are only applicable for child restraints fitted in the rear seat with the head restraints removed.

Tether anchor strap installation

1. Remove the head restraint from the location in which you wish to install a child restraint system.
2. Latch the attaching clip (A) of the child restraint system to the anchorage bar (B) and tighten the tether anchor strap so it is securely fastened.

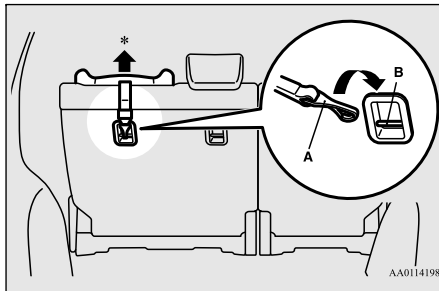

*: Front of the vehicle

NOTE

- If it is difficult to latch the tether strap hook, turn the hook sideways.

WARNING

- Child restraint anchorages are designed to withstand only those loads imposed by correctly fitted child restraints. Under no circumstances are they to be used for adult seatbelts, harnesses or for attaching other items or equipment to the vehicle. (According to ADR 34)

Installing a child restraint system to the lower anchorage (ISOFIX child restraint mountings)

E00408901919

The regulation concerning child restraint system may differ from country to country. Find out and follow the laws and regulations that apply to your country.

Lower anchorage location

Your vehicle's rear seat is fitted with lower anchorages for attaching a child restraint system with ISOFIX mountings.

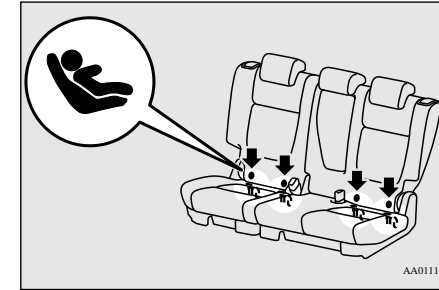

WARNING

- Child restraint anchorages are designed to withstand only those loads imposed by correctly fitted child restraints. Under no circumstances are they to be used for adult seatbelts, harnesses or for attaching other items or equipment to the vehicle.

Child restraint system with ISOFIX mountings

The child restraint system is designed only for seats that incorporate lower anchorages. Retain the child restraint system using the top tether strap and the lower anchorages.

It is not necessary to retain the child restraint system using the vehicle's seatbelts.

Child restraint

5

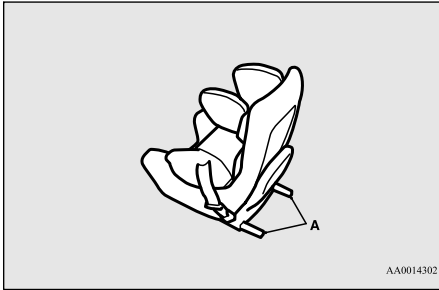

A: Child restraint system connectors

To install

1. Remove any foreign material in or around the connectors and ensure the vehicle seat belt is in its normal storage position.
2. Open the gap a little between the seat cushion (A) and the seatback (B) with your hand to locate the lower anchorages (C).

3. For easier access, the seatback may be recline rearward. Push the child restraint system's connectors (D) into the lower anchorages (C) in accordance with the instructions provided by the child restraint system's manufacturer.

After it is security fastened, adjust the seatback to 4 steps forward from most reclined position.

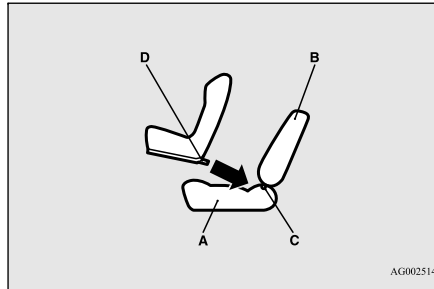

A: Vehicle seat cushion
B: Vehicle seatback
C: Lower anchorage
D: Connector

4. Attach the top tether anchor strap to the child restraint anchorage point and tighten the tether anchor strap (refer to page 5-16).
5. Push and pull the child restraint system in all directions to be sure it is firmly secured.

To remove

Remove the child restraint system in accordance with the instructions provided by the child restraint system's manufacturer.

Installing a child restraint system to a 3-point type seat belt (with emergency/automatic locking mechanism)

E00407002040

The 3-point type seat belts at the below illustrated seating position can be converted from normal emergency locking retractor (ELR) mode to automatic locking retractor (ALR) mode. It should be so converted, when installing a child restraint system to prevent the child restraint system from moving in case of an accident.

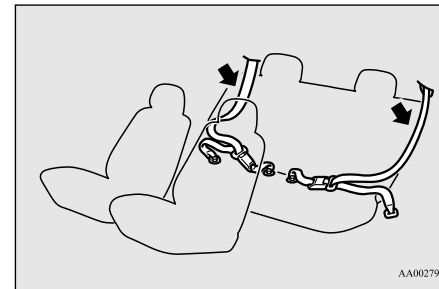

Child restraint

To install

1. Place the child restraint system on the rear seat.
2. Route the belt through the child restraint according to the child restraint system manufacturer's instructions, then insert the latch plate into the buckle.

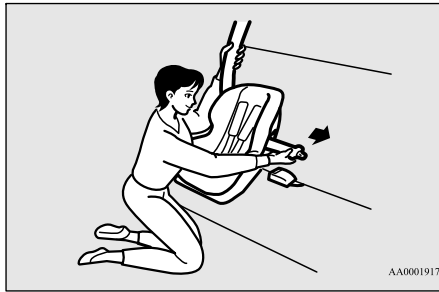

3. To activate the ALR mode, slowly pull the shoulder part of the belt all the way out until it stops, then let the belt feed back into the retractor.

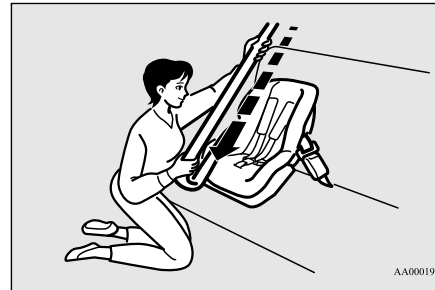

4. After the belt has retracted, tug on it. If the belt is locked, you will not be able to pull it out. If you can pull the belt out, it is not locked and you will need to repeat these steps.

5. After confirming that the belt is locked, grab the shoulder part of the belt near the buckle and pull up to remove any slack from the lap part of the belt. Remember, if the lap part of the belt is not tight, the child restraint will not be secure. It may help to put weight on the child restraint, or push on the seatback while pulling up on the belt.

5

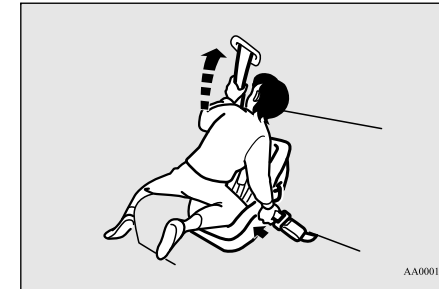

6. Attach the top tether anchor strap to the child restraint anchorage point and tighten the tether anchor strap (refer to page 5-16).
7. Before putting the child in the restraint, push and pull the restraint in all directions to be sure it is secure. Do this before each use.

NOTE

- If the seat belt does not lock, rewind it fully then perform step 2 to 7 again.

Child restraint

5

⚠ WARNING

● Before putting the child in the restraint, be sure to make the conversion of the retractor from the ELR mode to the ALR mode. By doing so, the child restraint system is always tightly secured to the seat by the automatic lock. By converting to ALR mode, the movement of the child restraint system in the event of sudden braking or an accident will be reduced, decreasing the risk of seriously injuring the child or other occupants.

📖 NOTE

● If a person wearing the seat belt moves their upper body significantly such that the belt completely unwinds, the retractor may switch to its ALR mode and lock, thus preventing further movement. If this happens, the person should switch the retractor back to its ELR mode by taking off the seat belt and fully rewinding it. The person should then wear the seat belt again.

To remove

1. Remove the plate from the buckle, then remove the seat belt from the child restraint system.
2. Fully rewind the seat belt to deactivate the ALR mode.

5-20 Seat and seat belts

Installing a child restraint system to a 3-point type seat belt (with emergency locking mechanism)

E00407101712

For safety, you are advised to install the child restraint system using a 3-point type seat belt with emergency/automatic locking mechanism. If you cannot avoid installing it using another type of seat belt, follow the instructions given below.

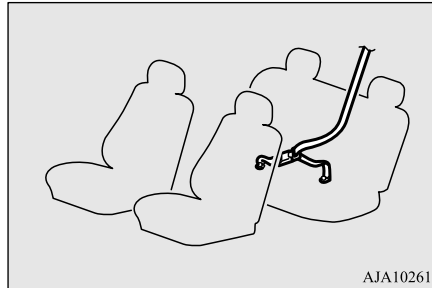

To install

1. Place the child restraint system on the rear seat.

2. Route the belt through the child restraint according to the child restraint system manufacturer's instructions, then insert the latch plate into the buckle.
3. Remove all slack by using the locking clip.
4. Attach the top tether anchor strap to the child restraint anchorage point and tighten the tether anchor strap (refer to page 5-16).
5. Before putting the child in the restraint, push and pull the restraint in all directions to be sure it is secure. Do this before each use.

To remove

Remove the plate from the buckle, then remove the seat belt from the child restraint system.

⚠ WARNING

● For some types of child restraint, the locking clip (A) should be used to help avoid personal injury during a collision or sudden manoeuvre.

It must be fitted and used in accordance with the child restraint manufacturer's instructions.

The locking clip must be removed when the child restraint is removed.

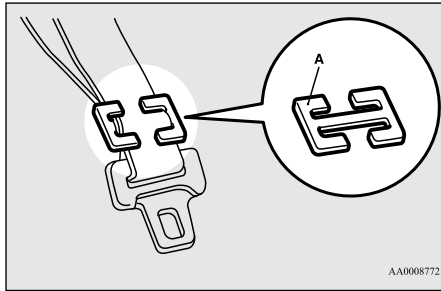

AA0008772

Seat belt inspection

E00406300576

- Check the belts for cuts, worn or frayed webbing and for cracked or deformed metallic parts. Replace the belt assembly if defective.
- A dirty belt should be cleaned with neutral detergent in warm water. After rinsing in water, let it dry in the shade. Do not attempt to bleach or re-dye the belts because this affects their characteristics.

WARNING

- We recommend you to have all seat belt assemblies including retractors and attaching hardware inspected after any collision. We recommend that seat belt assemblies in use during a collision be replaced unless the collision was minor and the belts show no damage and continue to operate properly.
- Do not attempt to repair or replace any part of the seat belt assemblies; we recommend you to have this work done by a MITSUBISHI MOTORS Authorised Service Point. Incorrect repair or replacement could reduce the effectiveness of the belts and could result in serious injury in the event of a collision.
- Once the pre-tensioner has activated, it cannot be re-used. It must be replaced together with the retractor.

Supplemental restraint system (SRS)-airbag

E00407203300

The information for SRS airbags includes important information concerning the driver's and front passenger's airbags, the driver's knee airbag, the side airbags and the curtain airbags.

Seat belt inspection

The SRS driver's and front passenger's airbags are designed to supplement the primary protection of the driver and front passenger side seat belt systems by providing those occupants with protection against head and chest injuries in certain moderate-to-severe frontal collisions.

5

The SRS driver's knee airbag is designed to supplement the primary protection of the driver's seat belt system. It can reduce the forward movement of the driver's lower legs and provide increased overall body protection in certain moderate-to-severe frontal collisions.

The SRS side airbags are designed to supplement properly worn seat belts and provide the driver and front passenger with protection against chest injuries in certain moderate-to-severe side impact collisions.

The SRS curtain airbags are designed to supplement properly worn seat belts and provide the driver and passenger with protection against head injuries in certain moderate-to-severe side impact collisions.

The SRS is NOT a substitute for the seat belts. To ensure the maximum protection during all types of collisions and accidents, all occupants, including the passengers as well as the driver, must wear their seat belts.

Supplemental restraint system (SRS)-airbag

How the supplemental restraint system works

E00407302812

The SRS includes the following components:

5

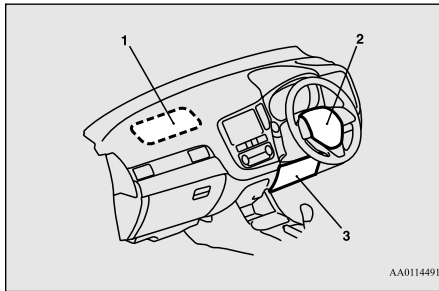

- 1- Airbag module (Passenger)
- 2- Airbag module (Driver)
- 3- Driver's knee airbag module

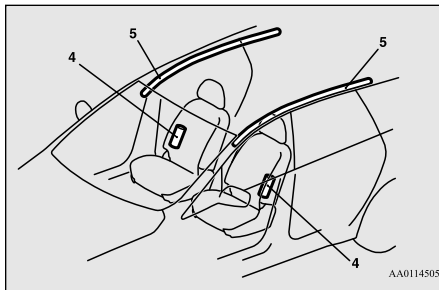

- 4- Side airbag modules

5-22 Seat and seat belts

5- Curtain airbag modules

Only when the operation mode of the power switch is in ON, the airbags will operate.

The airbags deployment produces a sudden, loud noise, and releases some smoke and powder, but these conditions are not injurious, and do not indicate a fire in the vehicle. People with respiratory problems may feel some temporary irritation from chemicals used to produce the deployment; open the windows after airbag deployment, if safe to do so.

The airbags deflate very rapidly after deployment, so there is little danger of obscured vision.

CAUTION

- Airbags inflate at an extremely rapid speed. In certain situations, contact with inflating airbags can result in abrasions, bruises, light cuts, and the like.

WARNING

- **IT IS VERY IMPORTANT TO BE PROPERLY SEATED.**
A driver or front passenger too close to the steering wheel or instrument panel during airbag deployment can be killed or seriously injured.
Airbags inflate very fast, and with great force.
If the driver and front passenger are not properly seated and restrained, the airbags may not protect you properly, and could cause serious or fatal injuries when it inflates.

WARNING

- Do not sit on the edge of the seat, or sit with your lower legs too close to the instrument panel, or lean head or chest close to the steering wheel or instrument panel. Do not put feet or legs on or against the instrument panel.
- Place all infants and small children in the rear seat and properly restrained using an appropriate child restraint system. The rear seat is the safest for infants and children.

Supplemental restraint system (SRS)-airbag

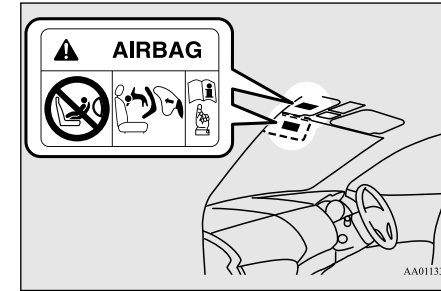
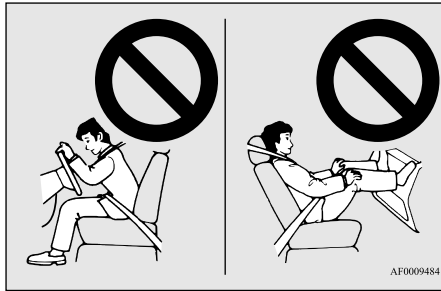

5

⚠ WARNING

- **Infants and small children should never be unrestrained, stand up against the instrument panel or held in your arms or on your lap. They could be seriously injured or killed in a collision, including when the airbag inflates. They should be properly seated in the rear seat in an appropriate child restraint system. See the “Child restraint” section of this owner’s manual.**

⚠ WARNING

- **Older children should be seated in the rear seat, properly wearing the seat belt, with an appropriate booster seat if needed.**

Caution for installing the child restraint on vehicle with front passenger’s airbag

E00408801862

The label shown here is attached on vehicles with front passenger’s airbag.

⚠ WARNING

- **Extreme Hazard!**
NEVER use a rearward facing child restraint on a seat protected by an ACTIVE AIRBAG in front of it, DEATH or SERIOUS INJURY to the CHILD can occur.

Driver’s and front passenger’s airbag system

E00407400792

The driver’s airbag is located under the padded cover in the middle of the steering wheel. The front passenger’s airbag is contained in the instrument panel above the glove box. The driver’s airbag and the front passenger’s airbag are designed to inflate at the same time even if the passenger seat is not occupied.

Supplemental restraint system (SRS)-airbag

5

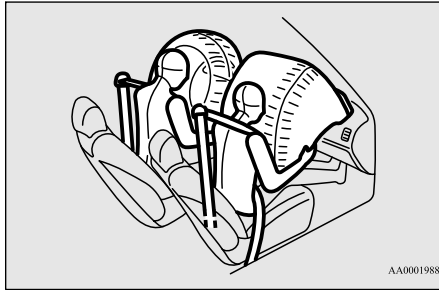

Deployment of front airbags and driver's knee airbag

E00407502700

The front airbags and driver's knee airbag ARE DESIGNED TO DEPLOY when...

The front airbags and driver's knee airbag are designed to deploy when the vehicle suffers a moderate to severe frontal impact. The typical condition is shown in the illustration.

Driver's knee airbag system

E00412400080

The driver's knee airbag is located under the steering wheel. The driver's knee airbag is designed to deploy at the same time as the driver's front airbag.

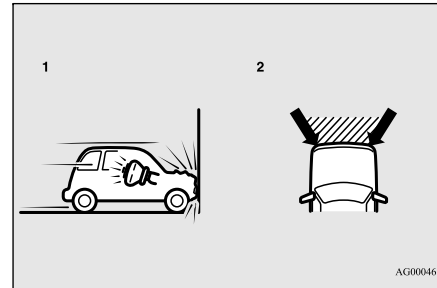

- 1- Head-on collision with a solid wall at speed of approximately 25 km/h or higher
- 2- Moderate to severe frontal impact within the shaded area between the arrows

The front airbags and driver's knee airbag will deploy if the severity of impact is above the designed threshold level, comparable to an approximately 25 km/h collision when impacting straight into a solid wall that does not move or deform. If the severity of the impact is below the above threshold level, the front airbags and driver's knee airbag may not deploy. However, this threshold speed will be considerably higher if the vehicle strikes an object that absorbs the impact by either deforming or moving (for example, another stationary vehicle, pole or a guard rail).

Because frontal collisions can easily move you out of position, it is important to always properly wear your seat belts. Your seat belts will help keep you a safe distance from the steering wheel and instrument panel during the initial stages of airbag deployment. The initial stage of airbag inflation is the most forceful, and can possibly cause serious or fatal injuries. Moreover, the seat belts in your vehicle are your primary means of protection in a collision. The SRS airbags are designed to provide additional protection. Therefore, for your safety and the safety of all occupants, be sure to always properly wear your seat belts.

The front airbags and driver's knee airbag MAY NOT DEPLOY when...

With certain types of frontal collisions, the vehicle's body structure is designed to absorb the shock to help protect the occupants from harm. (The vehicle body's front area may deform significantly as it absorbs the impact.) Under such circumstances, the front airbags and driver's knee airbag may not deploy irrespective of the deformation and damage to the vehicle body. Examples of some typical conditions are shown in the illustration.

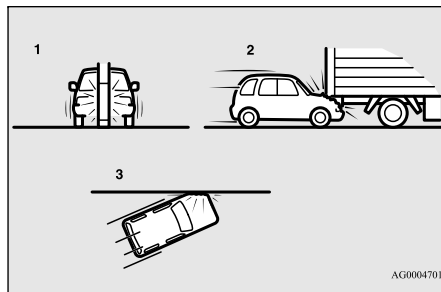

- 1- When colliding with a utility pole, tree or other narrow object.
- 2- Vehicle slides under the rear body of a truck
- 3- Oblique frontal impacts

Because the front airbags and driver's knee airbag do not protect the occupant in all types of frontal collisions, be sure to always properly wear your seat belts.

The front airbags and driver's knee airbag ARE NOT DESIGNED TO DEPLOY when...

The front airbags and driver's knee airbag are not designed to deploy in conditions where they cannot typically provide protection to the occupant. Such conditions are shown in the illustration.

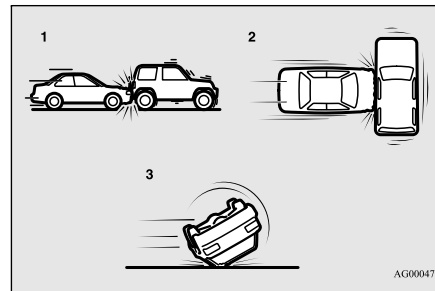

- 1- Rear end collisions
- 2- Side collisions
- 3- Vehicle rolls onto its side or roof

Because the front airbags and driver's knee airbag do not protect the occupant in all types

Supplemental restraint system (SRS)-airbag

of collisions, be sure to always properly wear your seat belts.

The front airbags and driver's knee airbag MAY DEPLOY when...

The front airbags and driver's knee airbag may deploy if the bottom of the vehicle suffers a moderate to severe impact (undercarriage damage). Examples of some typical conditions are shown in the illustration.

5

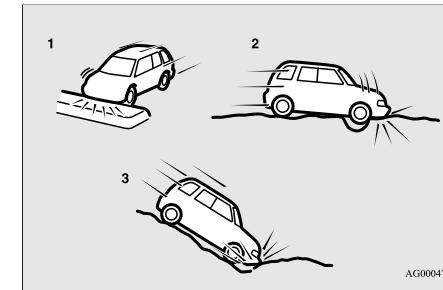

- 1- Collision with an elevated median/island or curb
- 2- Vehicle travels over a deep hole/pothole
- 3- Vehicle drives down a steep slope and hits the ground

Supplemental restraint system (SRS)-airbag

Because the front airbags and driver's knee airbag may deploy in certain types of unexpected impacts as shown in the illustration that can easily move you out of position, it is important to always properly wear your seat belts. Your seat belts will help keep you a safe distance from the steering wheel and instrument panel during the initial stages of airbag deployment. The initial stage of airbag inflation is the most forceful and can possibly cause serious or fatal injuries if you contact it at this stage.

5

⚠ WARNING

- Do not attach anything to the steering wheel's padded cover, such as badges or accessories. It might strike and injure an occupant if the airbag inflates.
- Do not set anything on, or attach anything to, the instrument panel above the glove box. It might strike and injure an occupant if the airbag inflates.

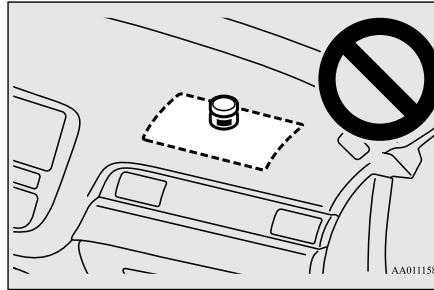

AA0111588

⚠ WARNING

- Do not attach accessories to, or put them in front of, the windscreen. These objects could restrict the airbag inflation, or strike and injure an occupant if the airbags inflate.
- Do not attach accessories to the lower portion of the driver's side instrument panel. Such objects could prevent the driver's knee airbag from inflating normally or could be propelled to cause serious injury if the airbag inflates.

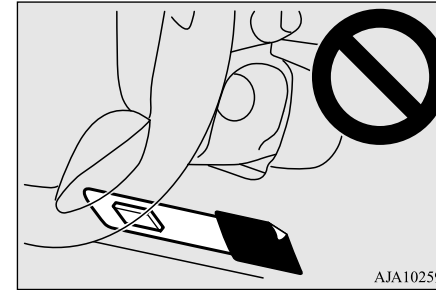

AJA102591

⚠ WARNING

- Do not put packages, pets or other objects between the airbags and the driver or front passenger. It could affect airbag performance, or could cause injury when the airbag inflates.
- Right after the airbag inflation, several airbag system components will be hot. Do not touch these components. There is a danger of being burnt.
- The airbag system is designed to work only once. Once the airbags have deployed, they will not work again. They must promptly be replaced and we recommend you to have the entire airbag system inspected by a MITSUBISHI MOTORS Authorised Service Point.

Side airbag system

E00407600619

The side airbags (A) are contained in the driver and front passenger seatbacks. The side airbag is designed to inflate only on the side of the vehicle that is impacted, even with no passenger in the front seat.

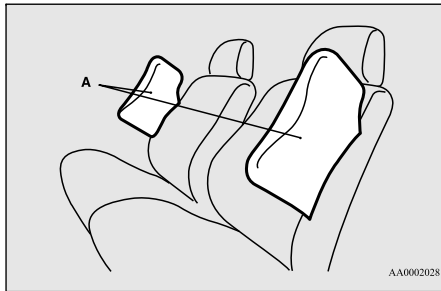

The label shown here is attached to the seatbacks with a side airbag.

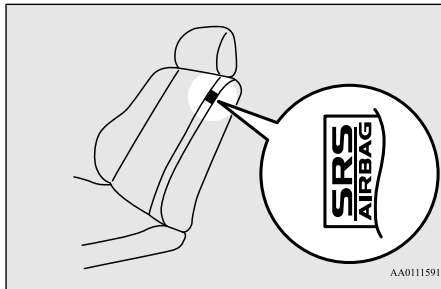

Curtain airbag system

E00409101686

The curtain airbags are contained in the front pillars and roof side rail. The curtain airbag is designed to inflate only on the side of the vehicle that is impacted, even with no passenger in the front seat or rear seat.

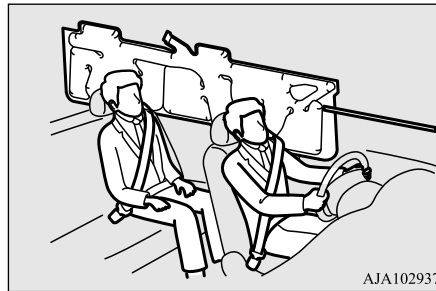

Deployment of side airbags and curtain airbags

E00407702513

The side airbags and curtain airbags ARE DESIGNED TO DEPLOY when...

The side airbags and curtain airbags are designed to deploy when the vehicle suffers a

Supplemental restraint system (SRS)-airbag

moderate to severe side impact to the middle of the passenger compartment. The typical condition is shown in the illustration.

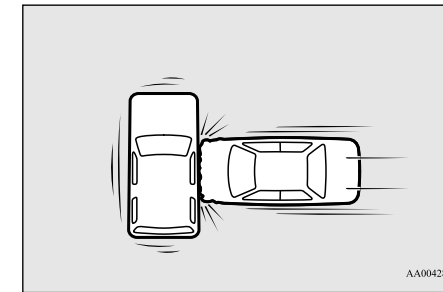

5

The seat belts in your vehicle are your primary means of protection in a collision. The SRS side airbags and curtain airbags are designed to provide additional protection. Therefore, for your safety and the safety of all occupants, be sure to always properly wear your seat belts.

The side airbags and curtain airbags MAY NOT DEPLOY when...

With certain types of side collisions, the vehicle's body structure is designed to absorb the shock to help protect the occupants from harm. (The vehicle body's side area may deform significantly as it absorbs the impact.)

Seat and seat belts 5-27

Supplemental restraint system (SRS)-airbag

Under such circumstances, the side airbags and curtain airbags may not deploy irrespective of the deformation and damage to the vehicle body. Examples of some typical conditions are shown in the illustration.

5

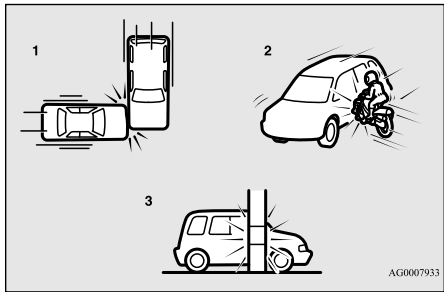

- 1- Side impacts in an area away from the passenger compartment
- 2- Motorcycle or other similar small vehicle collides with the side of vehicle
- 3- Collision with a utility pole, tree or other narrow object

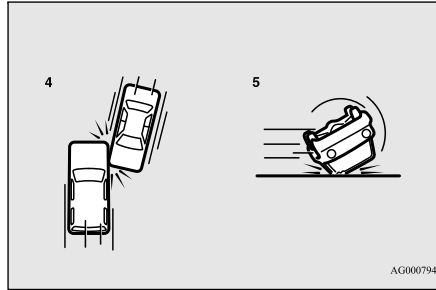

- 4- Oblique side impacts
- 5- Vehicle rolls onto its side or roof

Because the side airbags and curtain airbags do not protect the occupant in all types of side collisions, be sure to always properly wear your seat belts.

The side airbags and curtain airbags ARE NOT DESIGNED TO DEPLOY when...

The side airbags and curtain airbags are not designed to deploy in conditions where they cannot usually provide protection to the occupant. Typical conditions are shown in the illustration.

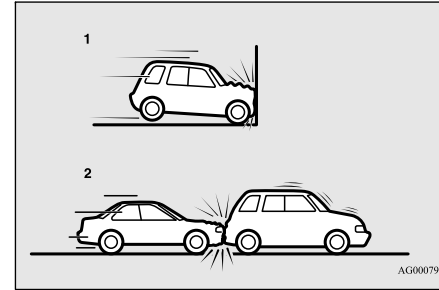

- 1- Head-on collisions
- 2- Rear end collisions

Because the side airbags and curtain airbags do not protect the occupant in all types of collisions, be sure to always properly wear your seat belts.

WARNING

- The side airbags and curtain airbags are designed to supplement the driver and passenger seat belts in certain side impacts. Seat belts should always be worn properly, and the driver and passenger should sit well back and upright without leaning against the window or door.

Supplemental restraint system (SRS)-airbag

⚠ WARNING

- The side airbag and curtain airbag inflate with great force. The driver and passenger should not put their arms out the window, and should not lean against the door, in order to reduce risk of serious or possible fatal injury from the deploying side airbag and curtain airbag.



⚠ WARNING

- Do not allow any rear seat occupant to hold onto the seatback of either front seat, in order to reduce risk of injury from the deploying side airbag. Special care should be taken with children.
- Do not place any objects near or in front of the seatback of either front seat. They could interfere with proper side airbag inflation, and also could cause injury if thrown free by side airbag deployment.

⚠ WARNING

- Do not place stickers, labels or additional trim on the seatback of either front seat. They could interfere with proper side airbag inflation.
- Do not install seat covers on seats with side airbags. Do not re-cover seats that have side airbags. This could interfere with proper side airbag inflation.
- Do not attach a microphone (A) or any other device or object around the part where the curtain airbags (B) activate such as on the windscreen, side door glass, front and rear pillars and roof side or assist grips. When the curtain airbags inflate, the microphone or other device or object will be hurled with great force or the curtain airbags may not activate correctly, resulting in death or serious injury.

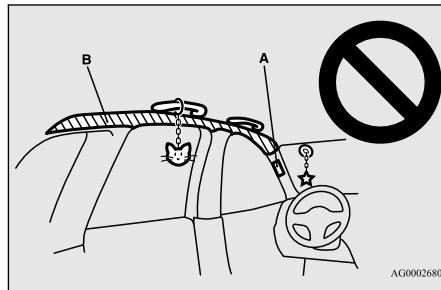

⚠ WARNING

- Do not put a hanger or any heavy or pointed object on the coat hook. If the curtain airbag was activated, any such item could be propelled away with great force and could prevent the curtain airbag from inflating correctly. Hang clothes directly on the coat hook (without using a hanger). Make sure there are no heavy or sharp objects in the pockets of clothes that you hang on the coat hook.
- Do not allow the child to lean against or close to the front door even if the child is seated in a child restraint system. The child's head should also not be leaned against or be close to the area where the side airbag and curtain airbag are located. It is dangerous if the side airbag and curtain airbag inflate. Failure to follow all of these instructions could lead to serious or fatal injury to the child.
- We recommend work around and on the side airbags and curtain airbags system to be done by a MITSUBISHI MOTORS Authorised Service Point.

Supplemental restraint system (SRS)-airbag

SRS warning lamp/display

E00407802673

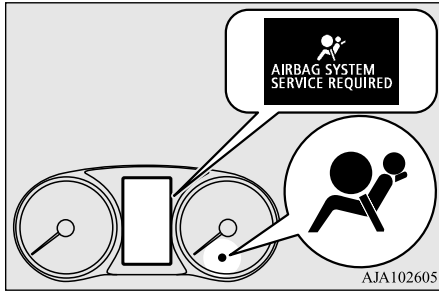

5

There is a supplemental restraint system (“SRS”) warning lamp on the instrument panel. The system checks itself every time the operation mode of the power switch is put in ON. The SRS warning lamp will come on for several seconds and then go out. This is normal and means the system is working properly.

If there is a problem involving one or more of the SRS components, the warning lamp will come on and stay on. At the same time, the warning display will appear on the information screen in the multi information display. The SRS warning lamp/display is shared by the SRS airbag and the seat belt pre-tensioner system.

⚠ WARNING

- If any of the following conditions occur, there may be a problem with the SRS airbags and/or seat belt pre-tensioners, and they may not function properly in a collision or may suddenly activate without a collision:

- Even when the operation mode is in ON, the SRS warning lamp does not come on or it remains on.
- The SRS warning lamp and/or the warning display comes on while driving.

The SRS airbags and seat belt pre-tensioners are designed to help reduce the risk of serious injury or death in certain collisions. If either of the above conditions occurs, immediately have your vehicle checked by a MITSUBISHI MOTORS Authorised Service Point.

SRS servicing

E00407901619

⚠ WARNING

- We recommend any maintenance performed on or near the components of the SRS to be performed by a MITSUBISHI MOTORS Authorised Service Point. Improper work on the SRS components or wiring could result in inadvertent deployment of the airbags, or could render the SRS inoperative; either situation could result in serious injury.

⚠ WARNING

- Do not modify your steering wheel, seat belt retractor or any other SRS components. For example, replacement of the steering wheel, or modifications to the front bumper or body structure (for example fitment of a frontal protection bar, including roo bars and bull bars except approved MITSUBISHI MOTORS GENUINE accessory parts) can adversely affect SRS performance and lead to possible injury.
- If your vehicle has received any damage, we recommend you to have the SRS inspected to ensure it is in proper working order.
- Do not modify your front seats, centre pillar and centre console. It can adversely affect SRS performance and lead to possible injury.
- If you found any tear, scratch, crack or damage to the portion where the airbag is stored, you should have the SRS inspected by a MITSUBISHI MOTORS Authorised Service Point.

📖 NOTE

- If your vehicle has to be scrapped, do this in line with local legislation and contact a MITSUBISHI MOTORS Authorised Service Point to safely dismantle the airbag system.

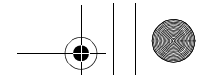

Instruments and controls

Instruments	6-2
Multi information display	6-3
Indicator lamp, warning lamp, and information screen display list	6-21
Indicator lamps	6-36
Warning lamps	6-37
Information screen display	6-39
Combination headlamps and dipper switch.....	6-40
Headlamp levelling	6-44
Turn-signal lever.....	6-45
Hazard warning flasher switch	6-45
ECO mode switch	6-46
Fog lamp switch	6-46
Wiper and washer switch	6-47
Wiper deicer switch*	6-53
Rear window demister switch.....	6-53
Horn switch.....	6-54

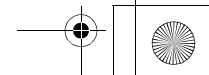
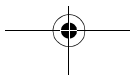

Instruments

Instruments

E0050010247

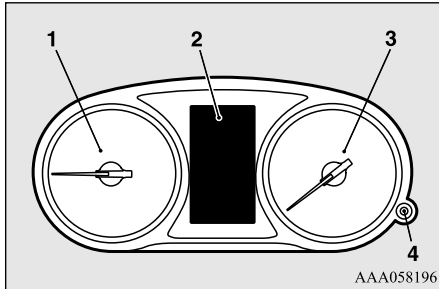

6

- 1- Energy usage indicator → P.6-2
- 2- Multi information display → P.6-3
Information screen display list
→ P.6-22
- 3- Speedometer (km/h or mph + km/h)
- 4- Rheostat illumination button → P.6-2

AAA058196

Energy usage indicator

E0053780028

Eco/Power zone

Indicates the total power of the motors and engine during driving.

Charge zone

Indicates the charging power generated by the regenerative brake.
The more the needle reflects, the more electric energy is charged.
The needle of the energy usage indicator may not enter the charge zone when the drive battery is close to full charge.

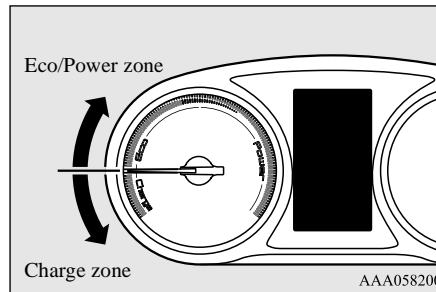

AAA058200

Meter illumination control

E00531301044

Each time you press the rheostat illumination button, there is a sound and the brightness of the instruments changes.

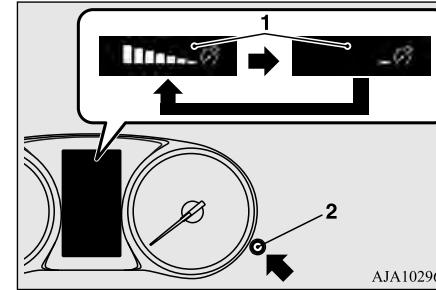

AJA102966

- 1- Brightness level
- 2- Rheostat illumination button

NOTE

- You can adjust to 8 different levels respectively for when the position lamps are illuminated and when they are not.
- If the vehicle is equipped with the automatic lamp control, when the lamp switch is in a position other than the "OFF" position, the meter illumination switches automatically to the adjusted brightness, depending on the brightness outside the vehicle.
- The brightness level of the instruments is stored when the operation mode of the power switch is put in OFF.

Multi information display

NOTE

- If you press and hold the button for about 2 seconds or more when the position lamps are illuminated, the brightness level changes to the maximum level. Pressing and holding the button for about 2 seconds or more again returns the brightness level to the previous level.

- 1-  mark display screen → P.6-9
- 2- Information screen → P.6-5
Interrupt display screen → P.6-8
- 3- Drive battery level display screen → P.6-9
- 4- Odometer → P.6-10
- 5- Door ajar warning display screen → P.6-9

Multi information display

E00519902119

Always stop the vehicle in a safe place before operating.

The following information is included on the multi information display: warnings, odometer, tripmeter, average fuel consumption, EV cruising range, total cruising range, EVHV driving rate, energy flow, etc.

[When the operation mode of the power switch is OFF]

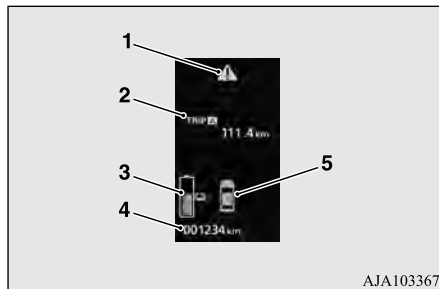

NOTE

- The drive battery level display screen appears when any of the doors or the tailgate is opened during charging.

6

Instruments and controls

6-3

Multi information display

[When the operation mode of the power switch is ON]

6

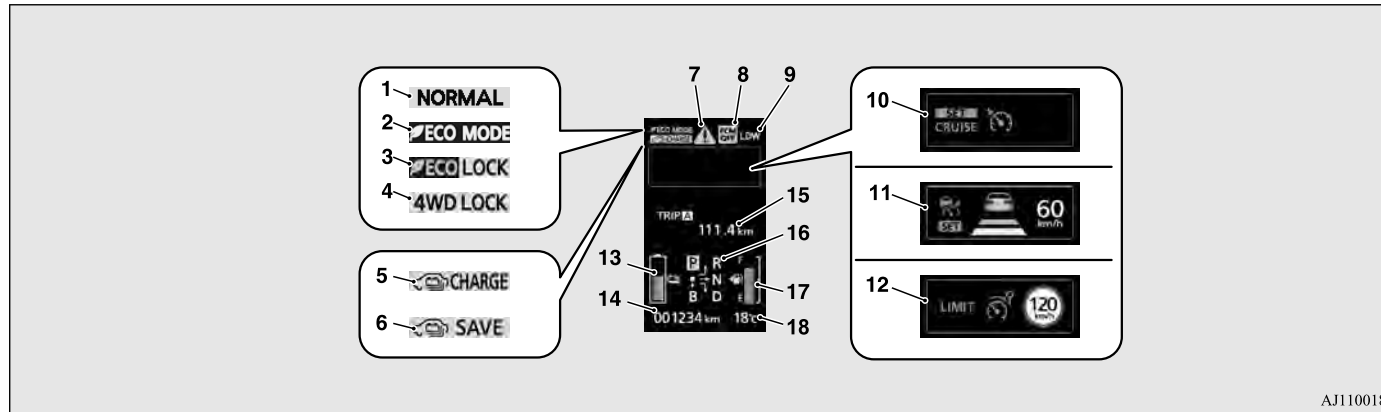

AJ1100188

- 1- NORMAL indicator display screen
Displayed when the ECO mode switch and 4WD lock switch are OFF.
- 2- ECO mode indicator display screen
Displayed when the ECO mode switch is ON and the 4WD lock switch is OFF.
- 3- ECO LOCK indicator display screen
Displayed when the ECO mode switch and 4WD lock switch are ON.
- 4- 4WD LOCK indicator display screen
Displayed when the ECO mode switch is OFF and the 4WD lock switch is ON.
→ ECO mode switch P. 6-46
→ 4WD lock switch P. 7-19

- 5- Battery charge mode display screen
→ P. 7-23
- 6- Battery save mode display screen
→ P. 7-22
- 7- mark display screen → P. 6-9
- 8- Forward Collision Mitigation System (FCM) OFF display screen* → P. 7-55
- 9- Lane Departure Warning (LDW) display screen* → P. 7-60
- 10- Cruise control display screen* → P. 7-35
- 11- Adaptive Cruise Control System (ACC) display screen* → P. 7-43
- 12- Speed limiter display screen* → P. 7-39
- 13- Drive battery level display screen
→ P. 6-9

- 14- Odometer → P. 6-10
- 15- Information screen → P. 6-7
- 16- Select position indicator → P. 7-15
- 17- Fuel remaining display screen → P. 6-9
- 18- Outside temperature display screen
→ P. 6-10

Multi information display switch

E00520001764

Each time the multi information display switch is operated, the buzzer sounds and the multi information display changes between information such as warnings, tripmeter,

Multi information display

average fuel consumption, EV cruising range, total cruising range, EVHV driving rate, energy flow, etc.

It is also possible to change elements such as the language and units used on the multi information display by operating the multi information display switch.

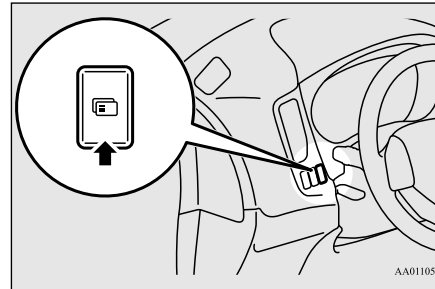

6

Information screen (when the operation mode is OFF)

E00520201812

Each time you lightly press the multi information display switch, the display screen switches in the following order.

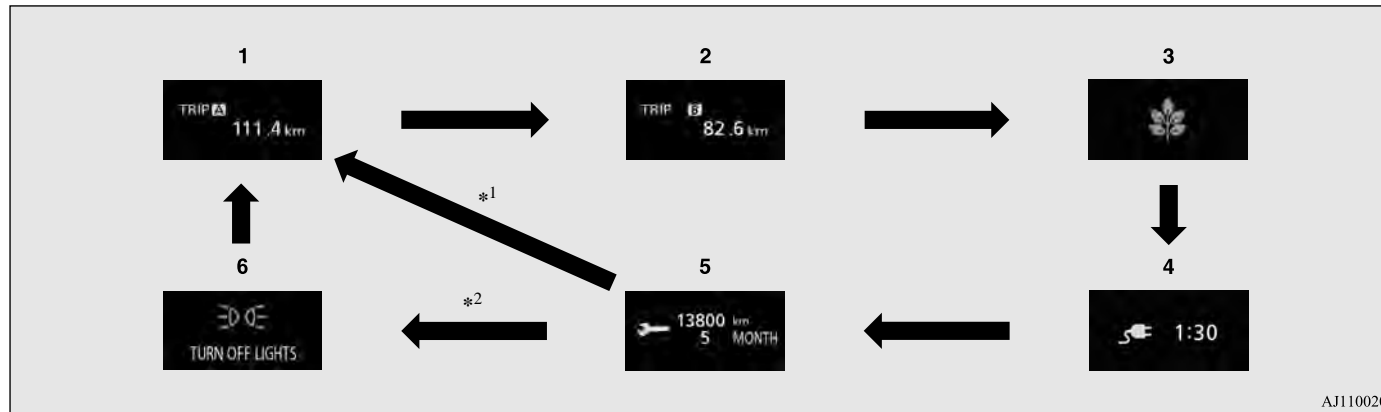

AJ1100205

*1: When there is no warning display

*2: When there is a warning display

Multi information display

- 1- Tripmeter **A** → P. 6-10
- 2- Tripmeter **B** → P. 6-10
- 3- ECO score display → P. 6-14
- 4- Prediction charging time → P. 3-8
- 5- Service reminder → P. 6-11
- 6- Redisplay of a warning display screen → P. 6-8

Information screen (when the operation mode is changed from OFF to ON)

6

E00520701918

When the operation mode is put in ON, the display screen switches in the following order.

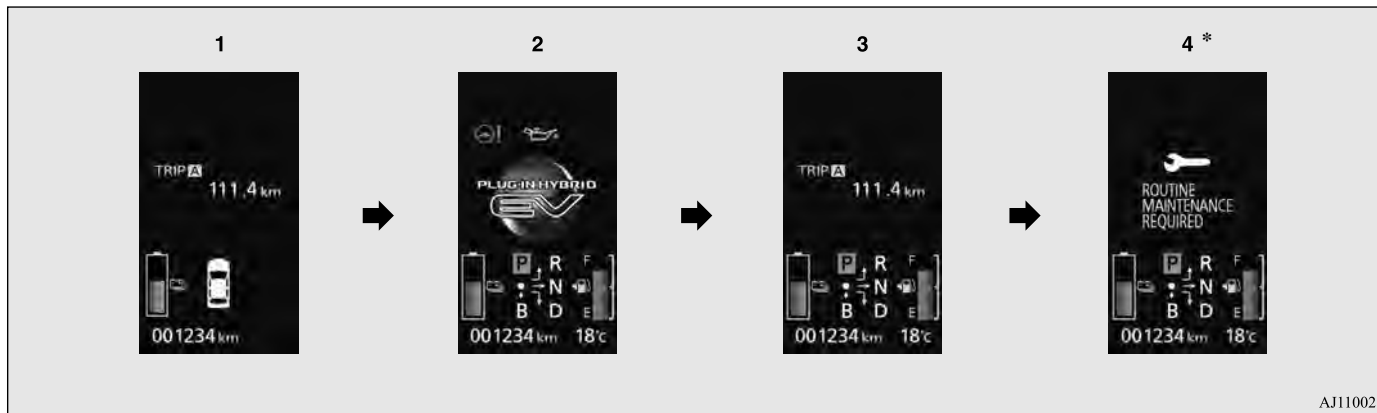

- *: When the inspection time has arrived
- 1- Screen when the operation mode is OFF
 - 2- System check screen → P.6-12
 - 3- Screen when the operation mode is ON
 - 4- Service reminder → P.6-11

6-6 Instruments and controls

Information screen (when the operation mode is ON)

E00521101788

Each time you lightly press the multi information display switch, the display screen switches in the following order.

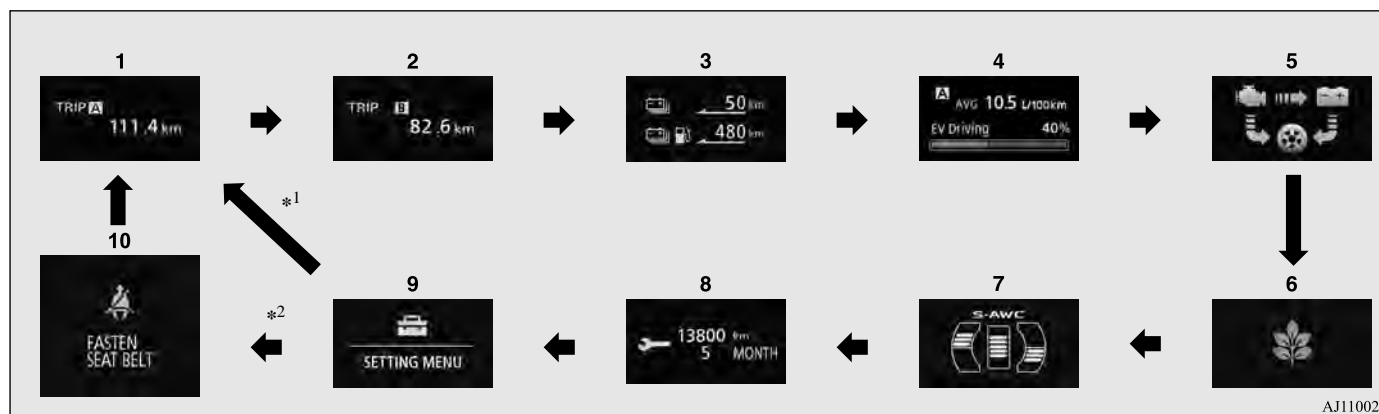

AJ1100221

*1: When there is no warning display

*2: When there is a warning display

1- Tripmeter **A** → P. 6-10

2- Tripmeter **B** → P. 6-10

3- EV cruising range display/Total cruising range display → P. 6-13

4- Average fuel consumption display → P. 6-13

EVHV driving rate display → P. 6-14

5- Energy flow display → P. 6-14

6- ECO score display → P.6-14

7- S-AWC (Super-All Wheel Control) operation display → P. 7-19

8- Service reminder → P. 6-11

9- Function setting screen → P. 6-15

Multi information display

10- Redisplay of a warning display screen → P. 6-8

NOTE

- While driving, the service reminder are not displayed even if you operate the multi information display switch. Always stop the vehicle in a safe place before operating.
- While driving, the function setting screen is not displayed even if you operate the multi information display switch.
Before operation, park the vehicle in a safe place, firmly apply the parking brake, press the electrical parking switch, and shift to “P” (PARK) position. Refer to “Changing the function settings” on page 6-15.
- When there is information to be announced, such as a system fault, the buzzer sounds and the screen display is switched.
Refer to “Interrupt display screen” on page 6-8.

6

Interrupt display screen

E00522001885

Warning display

When there is information to be announced, such as a system fault, the buzzer sounds and the information screen is switched to the warning display screen.

Refer to the warning list and take the necessary measures.

Refer to “Warning display list” on page 6-22. When the cause of the warning display is eliminated, the warning display goes out automatically.

To return to the screen displayed before the warning display

Even if the cause of the warning display is not eliminated, you can return to the screen

6-8 Instruments and controls





that was displayed before the warning display.

If you press the multi information display switch, the display screen switches to the screen that was displayed before the warning display and the  mark (A) is displayed.



AJA103295

NOTE

- Warning display screens with a  or  mark displayed in the upper right of the screen can be switched. If you want to switch the display, press the multi information display switch as follows.
: Press lightly.
: Press for about 2 seconds or more.

Redisplay of a warning display screen

When the  mark is displayed, if you lightly press the multi information display switch a few times, the warning display screen you switched from is redisplayed.

Multi information display

Other interrupt displays

The operation status of each system is displayed on the information screen.
Refer to the appropriate page in the warning display list for further details.
Refer to “Other interrupt displays” on page 6-33.

mark display screen

E00533901028

This is displayed when you press the multi information display switch and return from the warning display screen to the previous screen.

This mark is also displayed if there is another warning other than the one displayed.

When the cause of the warning display is eliminated, the  mark goes out automatically.

NOTE

- When the  mark is displayed, the warning display screen can be redisplayed on the information screen.
Refer to “Information screen (when the operation mode is OFF)” on page 6-5.
Refer to “Information screen (when the operation mode is ON)” on page 6-7.

Door ajar warning display screen

E00522601692



If any of the doors or the tailgate is not completely closed, this displays the open door or tailgate.

When the operation mode of the power switch is ON, if the vehicle speed exceeds approximately 8 km/h while a door is ajar, a buzzer sounds 4 times. This notifies the driver that a door is ajar.

CAUTION

- Before moving your vehicle, check that the warning lamp is OFF.

Drive battery level display screen

E00537700027



Indicates the remaining power in the drive battery.

Fuel remaining display screen

E00522201542

This displays the amount of fuel remaining.

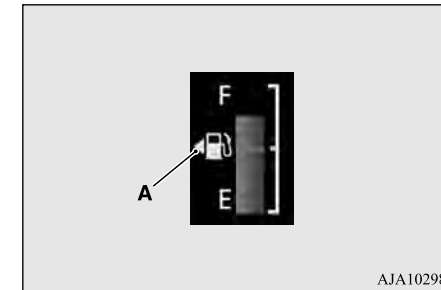

F- Full
E- Empty

NOTE

- It may take several seconds to stabilise the display after refilling the tank.
- If fuel is added with the operation mode of the power switch is in ON, the fuel gauge may incorrectly indicate the fuel level.
- The arrow (A) indicates that the fuel tank filler is located on the left side of the body.

6

Multi information display

Fuel remaining warning display

E00522401788

When the fuel is reduced to about 7 litres, the information screen switches to the interrupt display of the fuel remaining warning display, and the “” mark (B) on the fuel remaining display flashes slowly (about once per second). After a few seconds, the information screen returns from the fuel remaining warning display to the previous screen.

When the fuel is reduced further to about 5 litres, the information screen switches to the fuel remaining warning display and the “” mark (B) on the fuel remaining display flashes quickly (about twice per second).

6

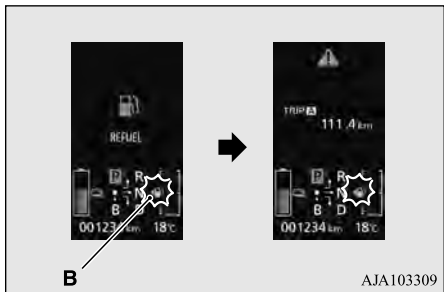

AJA103309

CAUTION

- If the warning display appears, refuel as soon as possible.
If the vehicle is runs out of fuel, the engine will not start even in a situation need to be generated electricity, the following conditions will occur.
- The driving performance falls (since only the electrical power stored in the drive battery can be used for the driving).
- The heating performance cannot be available (except vehicles with electric heater).
- The effectiveness of the heater is insufficient (vehicles with electric heater).
- The catalytic converter may be damaged due to excessive high temperature.

NOTE

- On inclines or curves, the display may be incorrect due to the movement of fuel in the tank.
- Battery save or battery charge may not be activated even if the battery save switch or the battery charge switch is pressed, depending on the remaining quantity of the drive battery or the control condition of the system.

Outside temperature display screen

E00522101509



This displays the temperature outside the vehicle.

NOTE

- The display setting can be changed to the preferred units (°C or °F).
Refer to “Changing the function settings” on page 6-15.
- Depending on factors such as the driving conditions, the displayed temperature may vary from the actual outside temperature.

Odometer

E00527800083

The odometer indicates the distance travelled.

Tripmeter

E00527901078

The tripmeter indicates the distance travelled between two points.

Multi information display

Example usage of tripmeter **A** and tripmeter **B**

It is possible to measure two currently travelled distances, from home using tripmeter **A** and from a particular point on the way using tripmeter **B**.

To reset the tripmeter

To return the display to 0, hold down the multi information display switch for about 2 seconds or more. Only the currently displayed value will be reset.

Example

If tripmeter **A** is displayed, only tripmeter **A** will be reset.

NOTE

- When disconnecting the auxiliary battery terminal, the memory of tripmeter **A** and **B** are cleared, and the display returns to “0”.

Service reminder

E00522502021

Displays the approximate time until the next periodic inspection recommended by

mitsubishi motors. “---” is displayed when the inspection time has arrived.

NOTE

- Depending on the vehicle specifications, the displayed time may differ from the next periodic inspection time recommended by MITSUBISHI MOTORS. In addition, the display settings for the next periodic inspection time can be modified. To modify the display settings, have it adjusted at a MITSUBISHI MOTORS Authorised Service Point. For more details, consult a MITSUBISHI MOTORS Authorised Service Point.

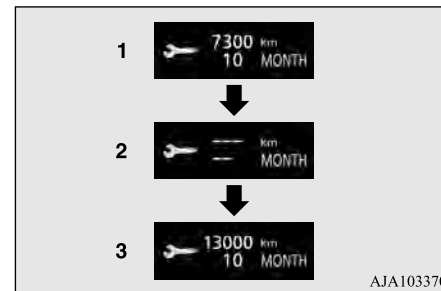

1. Displays the time until the next periodic inspection.

NOTE

- The distance is shown in units of 100 km (100 miles). The time is shown in units of months.

2. This informs you that a periodic inspection is due. We recommend you to consult a MITSUBISHI MOTORS Authorised Service Point.

At that time, when the operation mode is changed from OFF to ON, the warning display is displayed for a few seconds on the information screen.



3. After your vehicle is inspected at a MITSUBISHI MOTORS Authorised Service Point, it displays the time until the next periodic inspection.

To reset

The “---” display can be reset while the operation mode of the power switch is in OFF.

Multi information display

When the display is reset, the time until the next periodic inspection is displayed and the warning display is no longer displayed when the operation mode is changed from OFF to ON.

1. When you lightly press the multi information display switch a few times, the information screen switches to the service reminder display screen.

6

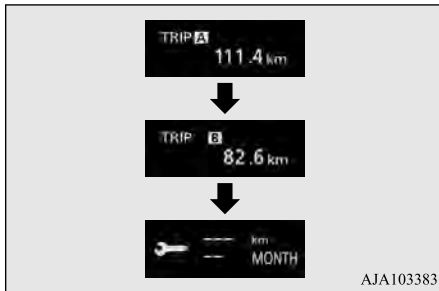

2. Press and hold the multi information display switch for about 2 seconds or more to display “” and make it flash. (If there is no operation for about 10 seconds with flashing, the display returns to the previous screen.)

3. Lightly press the multi information display switch while the icon is flashing to change the display from “---” to “CLEAR”. After this, the time until the next periodic inspection will be displayed.

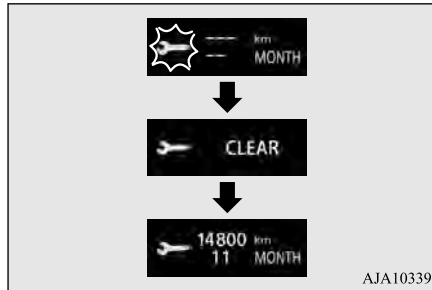

CAUTION

- The customer is responsible for making sure that periodic inspection and maintenance are performed. Inspections and maintenance must be performed to prevent accidents and malfunctions.

NOTE

- “---” display cannot be reset when the operation mode is in ON.
- When “---” is displayed, after a certain distance and a certain period of time, the display is reset and the time until the next periodic inspection is displayed.

NOTE

- If you accidentally reset the display, we recommend you to consult a MITSUBISHI MOTORS Authorised Service Point.

System check screen

E00531001038

When the operation mode is put in ON, the system check screen is displayed for about 4 seconds. If there is no fault, information screen (when the operation mode is ON) is displayed.

If there is a fault, the screen changes to warning display.

Refer to “Warning display list” on page 6-22.

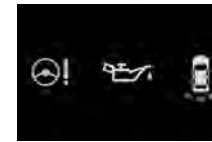

NOTE

- The system check screen display varies depending on the customer’s equipment.

Multi information display

EV cruising range display/Total cruising range display

E00537600026

This displays the approximate driving range (how many more kilometres or miles you can drive).

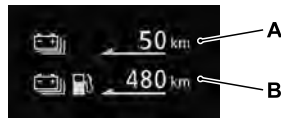

EV cruising range display (A)

This displays the distance that can be traveled with the remaining power in the drive battery.

Total cruising range display (B)

This displays the distance that can be traveled with the remaining power in the drive battery and the remaining amount of fuel.

NOTE

- The driving range may vary depending on the driving conditions and habits. Treat the distance displayed as just a rough guideline.
- When the drive battery is charged or the vehicle is refueled, the cruising range display is updated. However, if the charge level is low or the refueling amount is small, it cannot be updated correctly. Fully charge the battery or refill to full tank whenever possible.

NOTE

- On rare occasions, the value displayed for the driving range may change if you are parked on an extremely steep incline. This is due to the movement of fuel in the tank and does not indicate any malfunction.
- The display setting can be changed to the preferred units (km or miles). Refer to “Changing the function settings” on page 6-15.
- When the EV cruising range falls below approximately 1 km (1 mile), the EV cruising range display shows “---”.
- When the total cruising range falls below approximately 50 km (30 miles), the total cruising range display shows “---”.

Average fuel consumption display

E00531201072

This displays the average fuel consumption from the last reset to the present time.

There are the following 2 mode settings.

Refer to “Changing the reset mode for average fuel consumption” on page 6-16.

For information on how to change the average fuel consumption display setting, refer to “Changing the function settings” on page 6-15.



NOTE

- The average fuel consumption display can be reset separately for the auto reset mode and for the manual reset mode.
- “---” is displayed when the average fuel consumption cannot be measured or when it is 99.9 L/100 km (99.9 miles) or more.
- The initial (default) setting is “Auto reset mode”.
- The average fuel consumption will depend on the driving conditions (road conditions, how you drive, etc.). The displayed fuel consumption may vary from the actual fuel consumption. Treat the fuel consumption displayed as just a rough guideline.
- The memory of the auto reset mode or manual reset mode for the average fuel consumption display is erased if the auxiliary battery is disconnected.
- The display setting can be changed to the preferred units {km/L, mpg (US), mpg (UK) or L/100 km}. Refer to “Changing the function settings” on page 6-15.

Multi information display

EVHV driving rate display

E00537500025

This displays the ratios of the distance traveled with electric power and the distance traveled with both electric power and engine power.

The ratio of the distance traveled with electric power is displayed with a bar graph (blue) and in a percentage.

6

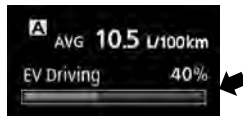

Energy flow display

E00537400024

This displays the flow of energy.

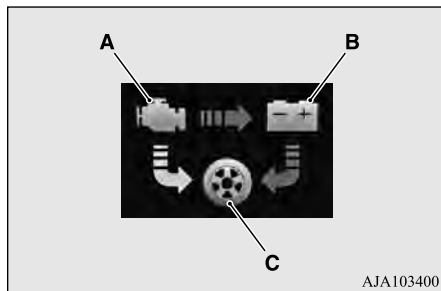

- A- Engine
- B- Drive battery

C- Tyre

Blue arrow- Flow of electric energy

Amber arrow- Flow of other energy

Display of energy flow (example)

■ When driving with electric energy



■ When driving with fuel (petrol) energy



■ When driving with both electric energy and fuel (petrol) energy



■ When charging the drive battery



■ When there is no energy flow



ECO Score

E00531601050

ECO score indicates the points you have scored on fuel-efficient driving by the number of leaves as follows:

[When the operation mode is ON]

Multi information display

The display shows the score you achieved in the last several minutes.

[When the operation mode is put in OFF]
The display shows the overall ECO score the function has counted from the time when the operation mode is set to "ON" to the time when it is set to "OFF".

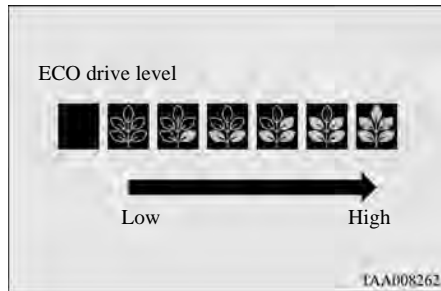

Changing the function settings

E00522701736

The "Display language", "Temperature unit", "Fuel consumption unit", and "Average fuel consumption and speed reset method" etc. setting can be modified as desired.

1. Stop the vehicle in a safe place.
Firmly apply the parking brake, and press the electrical parking switch and shift to "P" (PARK) position.

2. Lightly press the multi information display switch a few times to switch the information screen to the function setting screen.

Refer to "Information screen" on page 6-7.



CAUTION

- For safety, stop the vehicle before operating. While driving, even if you operate the multi information display switch, the function setting screen is not displayed.

3. Press and hold the multi information display switch for about 2 seconds or more to switch from the setting mode screen to the menu screen.

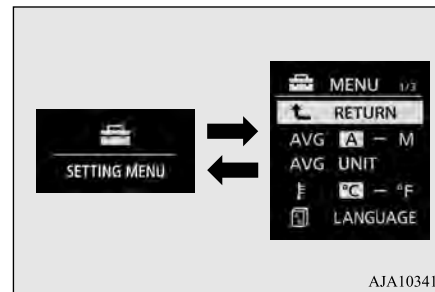

NOTE

- To return the menu screen to the function setting screen, press and hold the multi information display switch for about 2 seconds or more.
- If no operations are made within about 30 seconds of the menu screen being displayed, the display returns to the function setting screen.

6

Multi information display

4. Select the item to change on the menu screen and change to the desired setting. Refer to the following items for further details on the operation methods.

Refer to “Changing the reset mode for average fuel consumption” on page 6-16. Refer to “Changing the fuel consumption display unit” on page 6-17.

Refer to “Changing the temperature unit” on page 6-17.

Refer to “Changing the display language” on page 6-18.

Refer to “Changing the language cooperative control” on page 6-18.

Refer to “Operation sound setting” on page 6-19.

Refer to “Changing the time until “REST REMINDER” is displayed” on page 6-19.

Refer to “Changing the turn-signal sound” on page 6-20.

Refer to “Returning to the factory settings” on page 6-20.

6

NOTE

- If the auxiliary battery is disconnected, these function settings are reset from memory and is automatically to the factory settings.

Changing the reset mode for average fuel consumption

E00522902054

The mode conditions for the average fuel consumption display can be switched between “Auto reset” and “Manual reset”.

1. Press and hold the multi information display switch for about 2 seconds or more to switch from the setting mode screen to the menu screen. Refer to “Changing the function settings” on page 6-15.
2. Lightly press the multi information display switch to select “AVG (average fuel consumption)”.

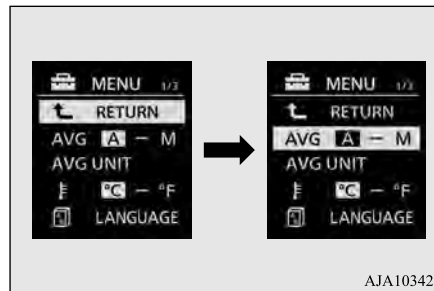

3. Press and hold the multi information display switch for about 2 seconds or more to switch from A/1 (Auto reset mode) to M/2/P (Manual reset mode), or from M/2/P to A/1.

The setting is changed to the selected mode condition.

Manual reset mode

- When the average fuel consumption is being displayed, if you hold down the multi information display switch, the average fuel consumption displayed at that time is reset.
- When the operation mode is changed from ACC or OFF to ON, the mode setting is automatically switched from manual to auto.

Switching to auto occurs automatically. If switching to manual mode is done, however, the data from the last reset is displayed.

Auto reset mode

- When the average fuel consumption is being displayed, if you hold down the multi information display switch, the average fuel consumption displayed at that time is reset.

Multi information display

- When the operation mode is in ACC or OFF for about 4 hours or longer, the average fuel consumption display is automatically reset.

NOTE

- The average fuel consumption display can be reset separately for the auto reset mode and for the manual reset mode.
- The memory of the auto reset mode or manual reset mode for the average fuel consumption display is erased if the auxiliary battery is disconnected.

2. Lightly press the multi information display switch to select “AVG UNIT (fuel consumption display setting)”.

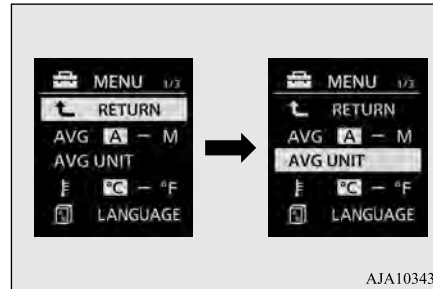

The distance units is also switched in the following combinations to match the selected fuel consumption unit.

Fuel consumption	Distance (driving range)
L/100 km	km
mpg (US)	mile (s)
mpg (UK)	mile (s)
km/L	km

6

Changing the fuel consumption display unit

E00523001778

The display unit for fuel consumption can be switched. The distance and amount units are also switched to match the selected fuel consumption unit.

1. Press and hold the multi information display switch for about 2 seconds or more to switch from the setting mode screen to the menu screen.
Refer to “Changing the function settings” on page 6-15.

3. Press and hold the multi information display switch for about 2 seconds or more to display “AVG UNIT”.
4. Lightly press the multi information display switch to select the units.
5. Press and hold the multi information display switch for about 2 seconds or more to change the setting to the selected unit.

NOTE

- The display units for the average fuel consumption and the driving range is switched, but the units for the indicating needle (speedometer), the odometer and the tripmeter will remain unchanged.

Changing the temperature unit

E00523101737

The display unit for temperature can be switched.

1. Press and hold the multi information display switch for about 2 seconds or more to switch from the setting mode screen to the menu screen.
Refer to “Changing the function settings” on page 6-15.
2. Lightly press the multi information display switch to select “F” (temperature unit setting).

Multi information display

- Press and hold the multi information display switch for about 2 seconds or more to switch in from °C to °F, or from °F to °C. The setting is changed to the selected temperature unit.

NOTE

- The temperature value on air conditioner panel is switched in conjunction with outside temperature display unit of the multi information display. However, “°C” or “°F” are not shown to temperature display of an air conditioner.
- On vehicles equipped with Mitsubishi Multi-Communication System (MMCS), the temperature value of the air conditioner screen of Mitsubishi Multi-Communication System (MMCS) is switched in conjunction with outside temperature display unit of the multi information display. However, “°C” or “°F” are not shown to the air conditioner screen.

6

Changing the display language

E00523201741

The language of the multi information display can be switched.

- Press and hold the multi information display switch for about 2 seconds or more to switch from the setting mode screen to the menu screen. Refer to “Changing the function settings” on page 6-15.
- Lightly press the multi information display switch to select “LANGUAGE” (language setting).

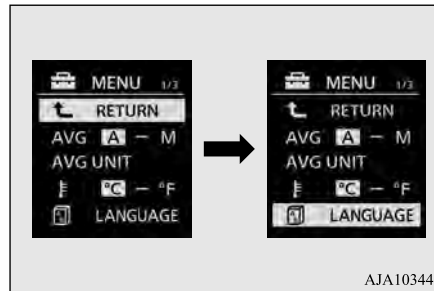

- Press and hold the multi information display switch for about 2 seconds or more to display “LANGUAGE”.
- Lightly press the multi information display switch to select the desired language.

- If you hold down the multi information display switch for about 2 seconds or more, the setting is changed to the selected language.

NOTE

- If “---” is selected in the language setting, a warning message is not displayed when there is a warning display or interrupt display.

Changing the language cooperative control

E00523301625

The language used in the Bluetooth® 2.0 interface (if so equipped) can be changed automatically to the same language as that shown in the multi information display.

- Press and hold the multi information display switch for about 2 seconds or more to switch from the setting mode screen to the menu screen. Refer to “Changing the function settings” on page 6-15.

Multi information display

2. Lightly press the multi information display switch to select “” (language cooperative control).

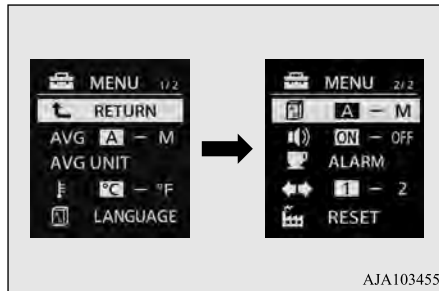

3. Press and hold the multi information display switch to switch from A (language cooperation enabled) to M (language cooperation disabled), or from M to A. The setting is changed to the selected condition.

NOTE

- The language display modified with the language setting can be switched in the following manner.

NOTE

- When A (language cooperation enabled) has been selected with the language cooperative control, the language for the Bluetooth® 2.0 interface (if so equipped) is automatically changed to the language selected for the multi information display. However, this changing function may not work depending on the language selected for the multi information display.
- When M (language cooperation disabled) has been selected with the language cooperative control, the language for the Bluetooth® 2.0 interface (if so equipped) is not automatically changed to the language selected for the multi information display.
- The language on the display of the audio system (if so equipped) is not automatically changed even if you select A (language cooperation enabled) of the language cooperative control.

Operation sound setting

E00523400690

You can turn off the operation sounds of the multi information display switch and rheostat illumination button.

1. Press and hold the multi information display switch for about 2 seconds or more to switch from the setting mode screen to the menu screen. Refer to “Changing the function settings” on page 6-15.
2. Lightly press the multi information display switch to select “” (operation sound setting).
3. Press and hold the multi information display switch for about 2 seconds or more to switch from ON (operation sound on) to OFF (operation sound off), or from OFF to ON. The setting is changed to the selected condition.

6

NOTE

- The operation sound setting only deactivates the operation sound of the multi information display switch and rheostat illumination button. The warning display and other sounds cannot be deactivated.

Changing the time until “REST REMINDER” is displayed

E00523501702

The time until the display appears can be changed.

Multi information display

6

1. Press and hold the multi information display switch for about 2 seconds or more to switch from the setting mode screen to the menu screen.
Refer to “Changing the function settings” on page 6-15.
2. Lightly press the multi information display switch to select “ALARM” (rest time setting).
3. Press and hold the multi information display switch for about 2 seconds or more to display “ALARM”.
4. Lightly press the multi information display switch to select the time until the display.
5. Press and hold the multi information display switch for about 2 seconds or more, the setting is changed to the selected time.

NOTE

- The drive time is reset when the operation mode of the power switch is put in OFF.

Changing the turn-signal sound

E00529100396

It is possible to change the turn-signal sound.

6-20 Instruments and controls

1. Press and hold the multi information display switch for about 2 seconds or more to switch from the setting mode screen to the menu screen.
Refer to “Changing the function settings” on page 6-15.
2. Lightly press the multi information display switch to select  (changing the turn-signal sound).
3. Press and hold the multi information display switch for about 2 seconds or more to switch from 1 (turn-signal sound 1) to 2 (turn-signal sound 2), or from 2 to 1.
The setting changes to the selected turn-signal sound.

Returning to the factory settings

E00523601875

All of the function settings can be returned to their factory settings.

1. Press and hold the multi information display switch for about 2 seconds or more to switch from the setting mode screen to the menu screen.
Refer to “Changing the function settings” on page 6-15.
2. Lightly press the multi information display switch to select “RESET” (returning to the factory settings).

3. When you press and hold the multi information display switch for about 5 seconds or more, the buzzer sounds and all of the function settings are returned to the factory settings.

NOTE

- The factory settings are as follows.
 - Average fuel consumption reset mode: A (Auto reset)
 - Fuel consumption display unit: L/100 km
 - Temperature unit: °C (Celsius)
 - Display language: ENGLISH or RUSSIAN
 - Cooperative language setting: A (language cooperation enabled)
 - Operation sounds: ON (Operation sounds on)
 - “REST REMINDER” display: OFF
 - Turn-signal sound: Turn-signal sound 1

Indicator lamp, warning lamp, and information screen display list

Indicator lamp, warning lamp, and information screen display list

E00523701182

Indicator and warning lamp list

E00523802034

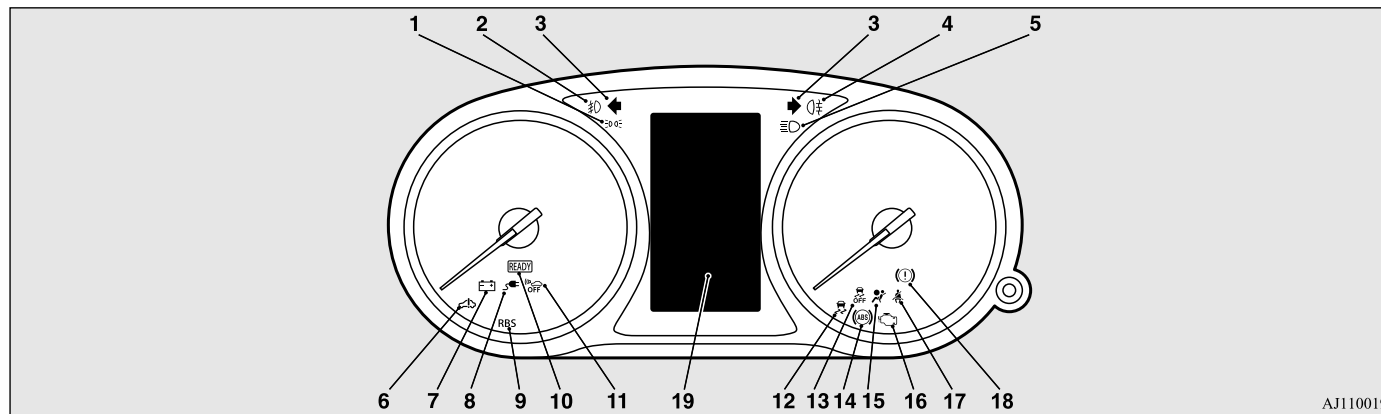

AJ1100191

- | | | |
|--|--|--|
| <p>1- Position lamp indicator lamp
→ P. 6-37</p> <p>2- Front fog lamp indicator lamp
→ P. 6-37</p> <p>3- Turn-signal indicator lamps/Hazard warning indicator lamps → P. 6-36</p> <p>4- Rear fog lamp indicator lamp*
→ P. 6-37</p> <p>5- High-beam indicator lamp → P. 6-37</p> <p>6- Plug-in Hybrid EV System warning lamp → P. 6-39</p> | <p>7- Auxiliary battery charge warning lamp
→ P. 6-39</p> <p>8- Charging indicator → P. 6-37</p> <p>9- Regenerative brake warning lamp
→ P. 6-39</p> <p>10- Ready indicator → P. 6-37</p> <p>11- Acoustic Vehicle Alerting System (AVAS) OFF indicator lamp → P. 7-24</p> <p>12- Active Stability Control (ASC) indicator lamp → P. 7-34</p> | <p>13- Active Stability Control (ASC) OFF indicator lamp → P. 7-34</p> <p>14- Anti-lock brake system (ABS) warning lamp → P. 7-30</p> <p>15- Supplemental restraint system (SRS) warning lamp
→ P. 5-30</p> <p>16- Check engine warning lamp → P. 6-38</p> <p>17- Seat belt warning lamp → P. 5-11</p> <p>18- Brake warning lamp → P. 6-37</p> |
|--|--|--|

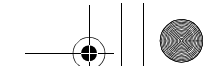

Indicator lamp, warning lamp, and information screen display list

19- Information screen display list
→ P. 6-22

Information screen display list

E00523901344

When there is information to be announced, such as lamp reminder, the buzzer sounds and the screen switches to the displays shown below. Refer to the appropriate page and take the necessary measures.

When the cause of the warning display is eliminated, the warning display goes out automatically.

6

Refer to “Warning display list” on page 6-22.

Refer to “Navigation information display” on page 6-32.

Refer to “Other interrupt displays” on page 6-33.

NOTE

- A warning may be displayed on the information screen and the buzzer may sound in the following rare cases.
This is caused by the system picking up interference such as noise or strong electromagnetic waves, and is not a functional problem.
 - An extremely strong electromagnetic wave is received from a source such as an illegal radio set, a spark from a wire, or a radar station.
 - Abnormal voltage or a static electricity discharge is generated by the operation of installed electrical equipment (including after-market parts).
- If the warning display appears many times, we recommend you to consult a MITSUBISHI MOTORS Authorised Service Point.

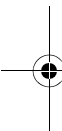

Warning display list

E00524001993

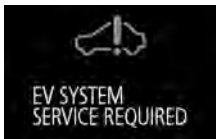



Screen	Cause	Solution (Reference)
	<ul style="list-style-type: none"> ● One or more minor failure is occurring in the Plug-in Hybrid EV System. 	<ul style="list-style-type: none"> ● Have your vehicle inspected by a MITSUBISHI MOTORS Authorised Service Point.

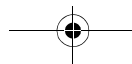

6-22 Instruments and controls









Indicator lamp, warning lamp, and information screen display list



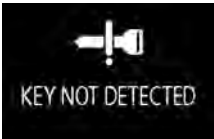

Screen	Cause	Solution (Reference)
	<ul style="list-style-type: none"> ● One or more failure is occurring in the Plug-in Hybrid EV System. 	<ul style="list-style-type: none"> ● Immediately park the vehicle in a safe place and contact a MITSUBISHI MOTORS Authorised Service Point.
	<ul style="list-style-type: none"> ● The parking lock unit is in failure. The Plug-in Hybrid EV system cannot be kept in standstill condition without applying the parking brake. 	<ul style="list-style-type: none"> ● Park the vehicle at a safe, flat place and apply the parking brake. Contact a MITSUBISHI MOTORS Authorised Service Point. Refer to “Electrical parking switch” on page 7-16.
	<ul style="list-style-type: none"> ● You are attempting to set the operation mode to “ON” when the charge connector is connected to the charge port. 	<ul style="list-style-type: none"> ● Disconnect the charge connector from the charge port before operating the power switch.
	<ul style="list-style-type: none"> ● Charging was interrupted due to system failure (electric leak detected). 	<ul style="list-style-type: none"> ● There is an electric leak or the normal charge cable is faulty. Immediately stop using the cable and contact a MITSUBISHI MOTORS Authorised Service Point.
	<ul style="list-style-type: none"> ● Charging was interrupted due to poor connection of the charge cable or power failure. 	<ul style="list-style-type: none"> ● Connect the charge cable correctly. Refer to “Normal charging” on page 3-8. ● If charging is interrupted due to a power failure, charging will be automatically resumed when the power is restored.

Indicator lamp, warning lamp, and information screen display list

6





Screen	Cause	Solution (Reference)
	<ul style="list-style-type: none"> The drive battery temperature is too cold. 	<ul style="list-style-type: none"> When the vehicle is under running, stop the vehicle at a safe place and contact a MITSUBISHI MOTORS Authorized Service Point. When the vehicle is in parking, in the daytime, wait for the outside temperature to rise and re-start the Plug-in hybrid system if the outside temperature has been risen. Refer to “Cautions and actions to deal with intense cold” on page 2-9.
	<ul style="list-style-type: none"> You have forgotten to turn off the lamps. 	Refer to “Lamps (headlamps, fog lamp, etc.) auto-cutout function” on page 6-40.
    	<ul style="list-style-type: none"> There is a fault in the keyless operation system. 	Refer to “Keyless operation system” on page 4-6.

Indicator lamp, warning lamp, and information screen display list

Screen	Cause	Solution (Reference)
 <p>KEY NOT DETECTED INSERT KEY INTO KEY SLOT</p>	<ul style="list-style-type: none"> ● The keyless operation key is not detected. 	<ul style="list-style-type: none"> ● Insert the keyless operation key into the key slot. Refer to “If the keyless operation key is not operating properly” on page 7-13.
 <p>REMOVE KEY FROM KEY SLOT</p>	<ul style="list-style-type: none"> ● You have forgotten to remove the keyless operation key from the key slot. 	<ul style="list-style-type: none"> ● Remove the keyless operation key from the key slot. Refer to “Keyless operation key reminder” on page 7-13.
 <p>POWER STEERING SERVICE REQUIRED</p>	<ul style="list-style-type: none"> ● There is a fault in the EPS. 	<ul style="list-style-type: none"> ● Have the vehicle inspected by a MITSUBISHI MOTORS Authorised Service Point as soon as possible. Refer to “Electric power steering system (EPS)” on page 7-32.
 <p>BRAKE SYSTEM SERVICE REQUIRED</p>	<ul style="list-style-type: none"> ● The brake fluid level in the reservoir has fallen to a low level. ● There is a fault in the brake system. 	<ul style="list-style-type: none"> ● Immediately stop the vehicle in a safe place. We recommend you to consult a MITSUBISHI MOTORS Authorised Service Point. Refer to “Brake warning display” on page 6-39.
	<ul style="list-style-type: none"> ● When the brake pedal has been repeatedly depressed over a short period of time, the brake warning lamp may come on and the brake warning buzzer may sound, and this warning may be displayed. 	<ul style="list-style-type: none"> ● If the this warning display is disappeared and brake warning lamp goes out and the buzzer stops a few seconds after stopping brake operation, there is no abnormality.





6

Indicator lamp, warning lamp, and information screen display list

Screen	Cause	Solution (Reference)
	<ul style="list-style-type: none"> The RBS (regenerative brake system) cannot be used. 	<ul style="list-style-type: none"> We recommend you to consult a MITSUBISHI MOTORS Authorised Service Point.
	<ul style="list-style-type: none"> There is a fault in the ABS. 	<ul style="list-style-type: none"> Avoid sudden braking and high-speed driving, stop the vehicle in a safe place, and take corrective measures. Refer to "ABS warning" on page 7-30.
	<ul style="list-style-type: none"> One of the doors or the tailgate is not completely closed. The open door is displayed. 	<ul style="list-style-type: none"> Close the door or tailgate. Refer to "Door ajar warning display screen" on page 6-9.
	<ul style="list-style-type: none"> The bonnet is open. 	<ul style="list-style-type: none"> Close the bonnet. Refer to "Bonnet" on page 11-3.
	<ul style="list-style-type: none"> There is a fault in the electronic immobilizer (Anti-theft starting system). 	<ul style="list-style-type: none"> Put the operation mode in OFF, and then start the Plug-in Hybrid EV System again. If the warning is not cancelled, please contact a MITSUBISHI MOTORS Authorised Service Point.

6





Indicator lamp, warning lamp, and information screen display list

Screen	Cause	Solution (Reference)
	<ul style="list-style-type: none"> An attempt was made to open the driver's door with the operation mode in any mode other than OFF. 	<ul style="list-style-type: none"> Put the operation mode in OFF. Refer to "Operation mode ON reminder system" on page 7-12.
	<ul style="list-style-type: none"> An attempt was made to lock all the doors and the tailgate with the operation mode is put in a mode other than OFF. 	<ul style="list-style-type: none"> Put the operation mode in OFF. Refer to "Operation mode OFF reminder system" on page 7-11.
	<ul style="list-style-type: none"> There is a fault in the electrical system. 	<ul style="list-style-type: none"> Immediately stop the vehicle in a safe place. We recommend you to consult a MITSUBISHI MOTORS Authorised Service Point.
	<ul style="list-style-type: none"> The engine is overheated. 	<ul style="list-style-type: none"> Stop the vehicle in a safe place and take corrective measures. Refer to "Engine overheating" on page 9-4.
	<ul style="list-style-type: none"> You put the operation mode in ON without fastening your seat belt. 	<ul style="list-style-type: none"> Fasten your seat belt properly. Refer to "Seat belt reminder" on page 5-11.
	<ul style="list-style-type: none"> There is a fault in the fuel system. 	<ul style="list-style-type: none"> We recommend you to consult a MITSUBISHI MOTORS Authorised Service point.



6

Indicator lamp, warning lamp, and information screen display list

6





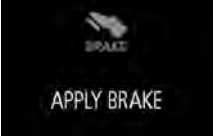

Screen	Cause	Solution (Reference)
 REFUEL	<ul style="list-style-type: none"> The fuel is running low. 	<ul style="list-style-type: none"> Refuel as soon as possible. Refer to “Fuel remaining warning display” on page 6-10.
 RELEASE PARKING BRAKE	<ul style="list-style-type: none"> You are driving with the parking brake still applied. 	<ul style="list-style-type: none"> Release the parking brake. Refer to “Brake warning display” on page 6-39.
 LOW OIL PRESSURE	<ul style="list-style-type: none"> There is a fault in the engine oil circulation system. 	<ul style="list-style-type: none"> Immediately stop the vehicle in a safe place. We recommend you to have it checked. Refer to “Oil pressure warning display” on page 6-40.
 AIRBAG SYSTEM SERVICE REQUIRED	<ul style="list-style-type: none"> There is a fault in the SRS airbag or the pre-tensioner system. 	<ul style="list-style-type: none"> We recommend you to have it checked, immediately. Refer to “Supplemental restraint system (SRS) warning lamp” on page 5-30.
 ASC SYSTEM SERVICE REQUIRED	<ul style="list-style-type: none"> There is a fault in the active stability control (ASC). 	<ul style="list-style-type: none"> We recommend you to have it checked. Refer to “Active stability control (ASC)” on page 7-32.
	<ul style="list-style-type: none"> There is a fault in the Hill start assist. 	<ul style="list-style-type: none"> We recommend you to have it checked. Refer to “Hill start assist” on page 7-27.

Indicator lamp, warning lamp, and information screen display list

Screen	Cause	Solution (Reference)
	<ul style="list-style-type: none"> ● The outside temperature is 3 °C (37 °F) or less. 	<ul style="list-style-type: none"> ● Be careful of ice on the road. ● The road can be icy even when this warning is not displayed, so drive carefully.
	<ul style="list-style-type: none"> ● The Adaptive Cruise Control System (ACC) has detected the approach of the vehicles in front. 	<ul style="list-style-type: none"> ● Increase the following distance by depressing the brake pedal or marking other decelerating control. Refer to “Adaptive Cruise Control System (ACC): Proximity alarm” on page 7-46.
	<ul style="list-style-type: none"> ● The Forward Collision Mitigation System (FCM) has detected the danger of collision. 	<ul style="list-style-type: none"> ● Take appropriate action such as depressing the brake to avoid collision. Refer to “FCM braking function” on page 7-56.
	<ul style="list-style-type: none"> ● The Adaptive Cruise Control System (ACC) detected a stop of the vehicle in front and stopped your vehicle, but the brake will be released soon. 	<ul style="list-style-type: none"> ● Depress the brake pedal as soon as your vehicle comes to a stop. Refer to “Adaptive Cruise Control System (ACC)” on page 7-43.







6

Indicator lamp, warning lamp, and information screen display list

Screen	Cause	Solution (Reference)
 ACC CANCELLED	<ul style="list-style-type: none"> The Adaptive Cruise Control System (ACC) control is automatically cancelled and the system is placed in the 'standby' state. 	Refer to "How to use ACC" on page 7-48.
 ACC NOT AVAILABLE NOW	<ul style="list-style-type: none"> Conditions for the start of control are not met, the Adaptive Cruise Control System (ACC) can not start the control. 	
 ACC OUT OF SPEED RANGE	<ul style="list-style-type: none"> The Adaptive Cruise Control System (ACC) can not start the control because the speed is out of speed range. 	
 ACC NO FORWARD VEHICLE	<ul style="list-style-type: none"> The Adaptive Cruise Control System (ACC) can not start the control because not detected the approach of the vehicles in front. 	
 ACC TEMPORARILY NOT AVAILABLE	<ul style="list-style-type: none"> The Adaptive Cruise Control System (ACC) is not available temporarily such as for adhesion of contaminants to the sensor. This is not a malfunction. 	
 ACC SERVICE REQUIRED	<ul style="list-style-type: none"> There is a fault in the Adaptive Cruise Control System (ACC). 	

6

Indicator lamp, warning lamp, and information screen display list

Screen	Cause	Solution (Reference)
	<ul style="list-style-type: none"> There is a fault in the Forward Collision Mitigation System (FCM). 	<ul style="list-style-type: none"> We recommend you to have it checked. Refer to “Forward Collision Mitigation System (FCM)” on page 7-55.
	<ul style="list-style-type: none"> FCM braking function of the Forward Collision Mitigation System (FCM) has been activated. 	Refer to “FCM braking function” on page 7-56.
	<ul style="list-style-type: none"> The Forward Collision Mitigation System (FCM) is not available temporarily such as for adhesion of contaminants to the sensor. This is not a malfunction. 	
	<ul style="list-style-type: none"> The Lane Departure Warning (LDW) has detected that your vehicle is about to leave or has left the lane. 	Refer to “Lane Departure Warning (LDW)” on page 7-60.
	<ul style="list-style-type: none"> The Lane Departure Warning (LDW) is not available temporarily for too high a temperature of the LDW camera. 	
	<ul style="list-style-type: none"> There is a fault in the Lane Departure Warning (LDW). 	<ul style="list-style-type: none"> We recommend you to have it checked. Refer to “Lane Departure Warning (LDW)” on page 7-60.

6

Indicator lamp, warning lamp, and information screen display list

Navigation information display*

E00531401032

On vehicles equipped with Mitsubishi Multi-Communication System (MMCS), the following information on navigation will be displayed when guidance location such as junction and destination is approached after you set the destination and started the route guidance.

6

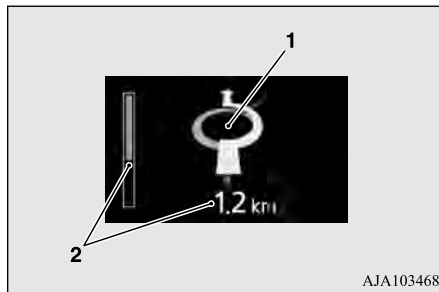

1- Guidance display

Shows the direction of vehicle travel and the guidance location.



Direction of vehicle travel
(Example)



Destination



Ferry terminal



Tollbooth



Intermediate destination
(Example)

AJE100348

2-Remaining distance display

Shows the distance to the location where the guidance is displayed.





NOTE

- Please read this section and also the separate owner's manual for Mitsubishi Multi-Communication System (MMCS).

Indicator lamp, warning lamp, and information screen display list

Other interrupt displays

E00524201836







Screen	System operation status	Reference
	<ul style="list-style-type: none"> When operating the Plug-in Hybrid EV System, the selector lever is in a position other than the “P” (PARK) position, or you pressed the power switch without depressing the brake pedal. 	<ul style="list-style-type: none"> Place the selector lever in the “P” (PARK) position, depress the brake pedal with the right foot. Then, press the power switch. Refer to “Starting and stopping the Plug-in Hybrid EV System” on page 7-12.
	<ul style="list-style-type: none"> Driving power is restricted by the safety system as the Plug-in Hybrid EV System has become too hot or too cold. 	<ul style="list-style-type: none"> You do not have to take any actions. The restriction on the driving power will be released when the Plug-in Hybrid EV System returns to the normal temperature.
	<ul style="list-style-type: none"> If the vehicle had not been refueled about 15 litres or more at one time for a long time, the engine starts automatically for the maintenance and fuel system components. This display may appear frequently depending on the use conditions of your vehicle such as when the fuel has been staying in the fuel tank for a long time. When the engine is running, this display shows the state where the drive battery is charged, and the battery charge mode display ( CHARGE) is displayed. 	<ul style="list-style-type: none"> Refill the 15 litres more at one time. This display and battery charge mode display will disappear, and the engine will stop.

6





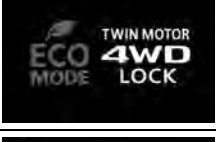

The operation status of each system is displayed on the information screen. Refer to the appropriate page for the system for further details.

Indicator lamp, warning lamp, and information screen display list

6

Screen	System operation status	Reference
	<ul style="list-style-type: none"> When charging of the drive battery is completed. 	Refer to “Charging” on page 3-2.
   	<ul style="list-style-type: none"> When the mode is changed by the operation of the 4WD lock switch or ECO mode switch. 	Refer to “ECO mode switch” on page 6-46. Refer to “4WD lock switch” on page 7-19. Refer to “When the ECO mode switch is ON” on page 7-20.
	<ul style="list-style-type: none"> When approaching the guidance location, etc. 	Refer to “Navigation information display” on page 6-32.

Indicator lamp, warning lamp, and information screen display list

Screen	System operation status	Reference
	<ul style="list-style-type: none"> ● When the battery save mode is activated. 	Refer to “Battery save switch” on page 7-22.
	<ul style="list-style-type: none"> ● When the battery charge mode is activated. 	Refer to “Battery charge switch” on page 7-23.
	<ul style="list-style-type: none"> ● When the reversing sensor system detect an obstruction. 	Refer to “Reversing sensor system” on page 7-63.
 	<ul style="list-style-type: none"> ● When the Forward Collision Mitigation System (FCM) is activated or the timing of an alarm is changed. 	Refer to “FCM ON/OFF switch” on page 7-59.
	<ul style="list-style-type: none"> ● When the Forward Collision Mitigation System (FCM) is deactivated. 	

6

This informs you that a periodic inspection is due.

Indicator lamps

Screen	Solution
	<p>We recommend you to have it checked. Refer to “Service reminder” for further details on page 6-11.</p>

The setting for rest interval can be changed.

6

Screen	Solution
	<p>Stop the vehicle in a safe place, stop the Plug-in Hybrid EV system, and take a rest. Use this display as rough guide for taking rests during a long drive. The interval from the start of your trip until this message is displayed can be set. Refer to “Changing the time until “REST REMINDER” is displayed” on page 6-19. The display and buzzer alert the driver when the set time is reached. If you continue to drive without having a rest, the buzzer sounds about every 5 minutes to encourage you to take a rest.</p> <ul style="list-style-type: none"> ● In the following cases, the time driven is reset and the display returns to the previous display screen. After this, when the set time is reached again, the buzzer and display encourage you to take a rest. <ul style="list-style-type: none"> • The buzzer sounds 3 times. • Put the operation mode in OFF. • The multi information display switch is held for about 2 seconds or more.

Indicator lamps

E00501600100

Turn-signal indicator lamps/Hazard warning indicator lamps

E00501701427

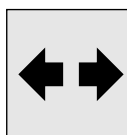

These indicator lamps blink in the following situations.

- When the turn-signal lever is moved to activate a turn-signal lamp.

Refer to “Turn-signal lever” on page 6-45.

- When the hazard warning flasher switch is pressed to activate the hazard warning lamps. Refer to “Hazard warning flasher switch” on page 6-45.

Warning lamps

- When the hazard warning lamps automatically activate due to sudden braking while driving. (Vehicle equipped with emergency stop signal system)
Refer to “Emergency stop signal system” on page 7-29.

High-beam indicator lamp

E00501800173

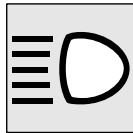

This indicator lamp illuminates when the high beam is used.

Front fog lamp indicator lamp

E00501901520

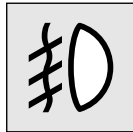

This lamp illuminates while the front fog lamps are on.

Rear fog lamp indicator lamp*

E00502000071

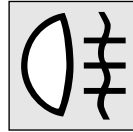

This lamp illuminates while the rear fog lamp is on.

Position lamp indicator lamp

E00508900173

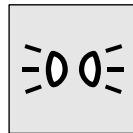

This indicator lamp illuminates while the position lamps are on.

Ready indicator

E00530101045



The ready indicator keeps flashing until Plug-in Hybrid EV System is activated. When the Plug-in Hybrid EV System has activated normally and the vehicle becomes ready to run, the lamp stops flashing and stays lit. Refer to “Starting the Plug-in Hybrid EV System” on page 7-12. If the indicator keeps flashing, the vehicles can not drive.

Charging indicator

E00530201020

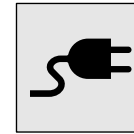

This indicator flashes when the normal charging cable is connected. After that, the lamp switches to being illuminated when charging starts and goes out when charging is completed.

Warning lamps

E00502400147

Brake warning lamp

E00502503673

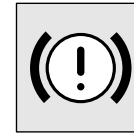

This lamp illuminates when the operation mode of the power switch is put in ON, and goes off after a few seconds.

Always make sure that the lamp goes off before driving.

With the operation mode in ON, the brake warning lamp illuminates under the following conditions:

- When the parking brake has been applied.
- When the brake fluid level in the reservoir falls to a low level.
- When the braking system is an abnormality.

Warning lamps

With the operation mode in ON, a buzzer sounds under the following condition:

- The vehicle speed exceeds 8 km/h with the parking brake applied.

CAUTION

- In the situations listed below, brake performance may be compromised or the vehicle may become unstable if brakes are applied suddenly; consequently, avoid driving at high speeds or applying the brakes suddenly. Furthermore, immediately the vehicle should be brought to a stop in a safe location and we recommend you to have it checked.
- The brake warning lamp does not illuminate when the parking brake is applied or does not turn off when the parking brake is released.
- The brake warning lamp and the ABS warning lamp illuminate at the same time. For details, refer to “ABS warning lamp” on page 7-30.
- The brake warning lamp remains illuminated while driving.
- The vehicle should be brought to a halt in the following manner when brake performance has deteriorated.
 - Depress the brake pedal harder than usual. Even if the brake pedal moves down to the very end of its possible stroke, keep it pressed down hard.

6

CAUTION

- Should the brakes fail, use regenerative braking to reduce your speed and carefully pull the parking brake lever. Depress the brake pedal to operate the stop lamp to alert the vehicles behind you.

Check engine warning lamp

E00502602938

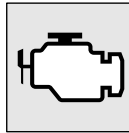

This lamp is a part of an onboard diagnostic system which monitors the emissions, engine control system.

If a problem is detected in one of these systems, this lamp illuminates or flashes.

Although your vehicle will usually be drivable and not need towing, we recommend you to have the system checked as soon as possible.

This lamp will also illuminate when the operation mode of the power switch is put in ON, and goes off after the Plug-in Hybrid EV System has started. If it does not go off after the Plug-in Hybrid EV System has started, we recommend you to have the vehicle checked.

CAUTION

- Prolonged driving with this lamp on may cause further damage to the emission control system. It could also affect fuel economy and drivability.
- If the lamp does not illuminate when the operation mode is put in ON, we recommend you to have the system checked.
- If the lamp illuminates while the Plug-in Hybrid EV System is operating, avoid driving at high speeds and have the system inspected by a MITSUBISHI MOTORS Authorised Service Point as soon as possible.

NOTE

- The engine electronic control module accommodating the onboard diagnostic system has various fault data (especially about the exhaust emission) stored.

This data will be erased if a auxiliary battery cable is disconnected which will make a rapid diagnosis difficult. Do not disconnect a auxiliary battery cable when the check engine warning lamp is ON.

Auxiliary battery charge warning lamp

E00502702287

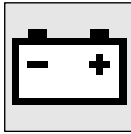

This warning lamp will illuminate when there is a problem with the charging system for the auxiliary battery.

Normally, when the operation mode of the power switch is put in ON, this warning lamp will illuminate. Then, when the Plug-in Hybrid EV System is started and the ready indicator illuminates, the warning lamp will go out.

CAUTION

- If the warning lamp stays on after the ready indicator illuminates, there may be a problem with the charging system for the auxiliary battery.
- Immediately park your vehicle in a safe place and we recommend you to have it checked.
- Do not charge the auxiliary battery.

Plug-in Hybrid EV System warning lamp

E00537300023

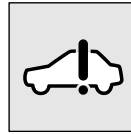

This warning lamp will illuminate when there is a fault at the Plug-in Hybrid EV System.

Refer to “Service precautions”

on page 11-2.

Normally, this warning lamp illuminates when the operation mode of the power switch is put in ON, and goes off after a few seconds.

CAUTION

- If the lamp illuminates while the Plug-in Hybrid EV System is operating, immediately park your vehicle in a safe place and we recommend you to consult a MITSUBISHI MOTORS Authorised Service Point.

Regenerative brake warning lamp

E00537200022



This warning lamp will illuminate when there can not be used at the regenerative brake while the Plug-in Hybrid EV System is operating.

The warning is also displayed on the multi information display.

Information screen display

Normally, this warning lamp illuminates when the operation mode of the power switch is put in ON, and goes off after the Plug-in Hybrid EV System is activated.

CAUTION

- If the lamp illuminates while the Plug-in Hybrid EV System is operating, we recommend you to have the vehicle inspected by a MITSUBISHI MOTORS Authorised Service Point.

6

Information screen display

E00524601117

Brake warning display

E00524701381



This warning is displayed if you drive with the parking brake still applied. The warning lamp in the instrument cluster only illuminates when the parking brake is applied.

Combination headlamps and dipper switch

CAUTION

- If a vehicle is driven without releasing the parking brake, the brake will be overheated, resulting in ineffective braking and possible brake failure.
If this warning is displayed, release the parking brake.

6



When the operation mode of the power switch is put in ON, if the brake fluid is low, this warning is displayed. The warning lamp in the instrument cluster also illuminates.

CAUTION

- If this warning stays illuminated and does not go out while driving, there is a danger of ineffective braking. If this happens, immediately park your vehicle in a safe place and we recommend you to have it checked.

CAUTION

- If the brake warning display is displayed and the brake warning lamp and the ABS warning lamp are illuminated at the same time, the braking force distribution function will not operate, so the vehicle may be destabilised during sudden braking. Avoid sudden braking and high-speed driving, stop the vehicle in a safe place, and we recommend you to have it checked.
- The vehicle should be brought to a halt in the following manner when brake performance has deteriorated.
 - Depress the brake pedal harder than usual. Even if the brake pedal moves down to the very end of its possible stroke, keep it pressed down hard.
 - Should the brakes fail, use regenerative brake to reduce your speed and carefully pull the parking brake lever. Depress the brake pedal to operate the stop lamp to alert the vehicles behind you.

Oil pressure warning display

E00524901309



If the engine oil pressure drops while the Plug-in Hybrid EV System is operating, the

warning display is displayed on the information screen in the multi information display.

CAUTION

- If the vehicle is driven while the engine oil is low, or the oil level is normal but the warning is displayed, the engine may burn out and be damaged.
- If the warning is displayed while the Plug-in Hybrid EV System is operating, immediately park your vehicle in a safe place and check the engine oil level.
- If the warning is displayed while the engine oil level is normal, have it inspected.

Combination headlamps and dipper switch

E00506003416

Headlamps

NOTE

- Do not leave the lights on for a long time while the Plug-in Hybrid EV System is stationary (not operating). A run-down auxiliary battery could result.

Combination headlamps and dipper switch

NOTE

- When it rains, or when the vehicle has been washed, the inside of the lens sometimes becomes foggy, but this does not indicate a functional problem. When the lamp is switched on, the heat will remove the fog. However, if water gathers inside the lamp, we recommend you to have checked.

Type 1

Rotate the switch to turn on the lamps.

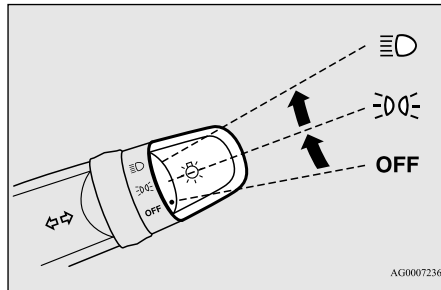

OFF	All lamps off
	Position, tail, licence plate, instrument panel lamps and downlight on
	Headlamps and other lamps go on

Type 2

Rotate the switch to turn on the lamps.

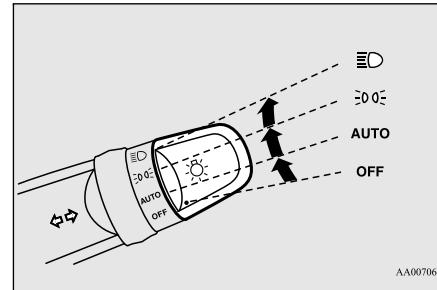

OFF	All lamps off
AUTO	With the operation mode of the power switch is in ON, headlamps, position, tail, licence plate, instrument panel lamps and downlight turn on and off automatically in accordance with outside light level. All lamps turn off automatically when the operation mode is put in OFF.
	Position, tail, licence plate, instrument panel lamps and downlight on
	Headlamps and other lamps go on

NOTE

- The sensitivity of the automatic on/off control can be adjusted. For further information, contact a MITSUBISHI MOTORS Authorised Service Point. On vehicles equipped with Mitsubishi Multi-Communication System (MMCS), screen operations can be used to make the adjustment. Refer to the separate owner's manual for details.

- If the front fog lamps turn on when they are supposed to with the switch in the "AUTO" position, the lamps turn off automatically with operation mode off.
- Do not cover the sensor (A) for the automatic on/off control by affixing a sticker or label to the windscreen.

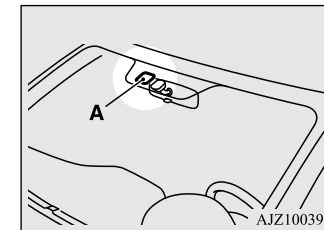





- If the lamps do not turn on or off with the switch in the "AUTO" position, manually operate the switch and we recommend you to have your vehicle checked.

Combination headlamps and dipper switch

Lamps (headlamps, fog lamp, etc.) auto-cutout function



6

- If the operation mode of the power switch is put in OFF or ACC while the lamp switch is in the “” or “” position, the lamps will turn off automatically when the driver’s door is opened.
- If the operation mode of the power switch is put in OFF or ACC while the lamp switch is in the “” or “” position, the lamps will remain on for about 3 minutes while the driver’s door is shut and will then automatically turn off.

NOTE

- The lamp auto-cutout function can also be disabled.
For further information, we recommend you to consult a MITSUBISHI MOTORS Authorised Service Point.
On vehicles equipped with Mitsubishi Multi-Communication System (MMCS), screen operations can be used to make the adjustment. Refer to the separate owner’s manual for details.

When you want to keep the lamps on:

1. Turn the lamp switch in the “OFF” position while the operation mode of the power switch is in OFF or ACC.
2. Turn on the lamps with the switch in the “” or “” position again, then the lamps will remain on.

NOTE

- If you place the light switch in the “” position, the lamps will not be automatically turned off.

3. When 1 minute has passed, the lamps will automatically be turned off.

Lamp monitor buzzer

E00506101631

If the driver’s door is opened when the operation mode of the power switch is put in ACC or OFF with the lamps illuminated, a buzzer will sound to remind the driver to turn off the lamps.

The buzzer will automatically stop if the auto-cutoff function is activated, the lamp switch is turned off, or the door is closed.

Dipper (High/Low beam change)

E00506201544

When the lamp switch is in the “” position, the beam changes from high to low (or low to high) each time the lever is pulled fully (1). While the high beam is on, the high beam indicator lamp in the instrument cluster will also illuminate.

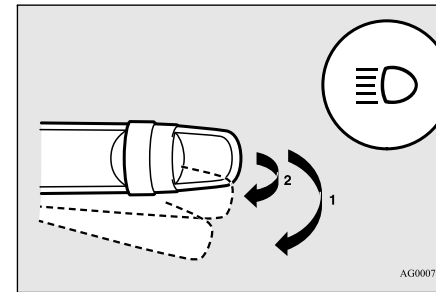

AG0007249

Headlamp flasher

E00506300199

The high beams flash when the lever is pulled slightly (2), and will go off when it is released.

When the high beam is on, the high beam indicator lamp in the instrument cluster will illuminate.

Combination headlamps and dipper switch

NOTE

- The high beams can also flash when the lamp switch is OFF.
- If you turn the lamps off with the headlamps set to highbeam, the headlamps are automatically returned to their low-beam setting when the lamp switch is next turned to the “” position.

Welcome light



E00528901600

This function turns on the position and tail lamps for about 30 seconds after the UNLOCK switch on the remote control transmitter is pressed when the combination headlamps and dipper switch is in the “OFF” or “AUTO” position (for vehicles equipped with the automatic lamp control). On vehicles equipped with the automatic lamp control (except for vehicles equipped with LDW), the welcome light function will operate only when it is dark outside the vehicle.

NOTE

- While the welcome light function is operating, perform one of the following operations to cancel the function.
 - Push the LOCK switch on the remote control transmitter.

NOTE

- Turn the combination headlamps and dipper switch to the “” or “” position.
- Put the operation mode of the power switch in ON.
- It is possible to modify functions as follows:
 - The headlamps can be set to come on in the low beam setting.
 - The welcome light function can be deactivated.

For further information, please contact your MITSUBISHI MOTORS Authorised Service Point.

On vehicles equipped with Mitsubishi Multi-Communication System (MMCS), screen operations can be used to make the adjustment. Refer to the separate owner’s manual for details.

Coming home light

E00529001549

This function turns on the headlamps in the low beam setting for about 30 seconds after the operation mode is put in OFF.

1. Turn the combination headlamps and dipper switch to the “OFF” or “AUTO” position (for vehicles equipped with the automatic lamp control).
2. Put the operation mode of the power switch in OFF.

3. Within 60 seconds of putting the operation mode in OFF, pull the turn signal lever towards you.

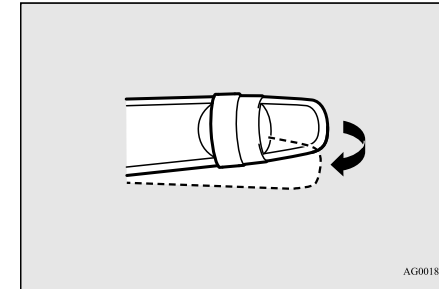

6

4. The headlamps will come on in the low beam setting for about 30 seconds. After the headlamps go off, the headlamps can be turned on again in the low beam setting for about 30 seconds by pulling the turn signal lever towards you within 60 seconds of putting the operation mode in OFF.



To turn on the headlamps again after 60 seconds of putting the operation mode in OFF, repeat the process from step 1.

NOTE

- While the coming home light function is operating, perform one of the following operations to cancel the function.
 - Pull the turn signal lever towards you.

Headlamp levelling

NOTE

- Turn the combination headlamps and dipper switch to the “” or “” position.
- Put the operation mode in ON.
- It is possible to modify functions as follows:
 - The time that the headlamps remain on can be changed.
 - The coming home light function can be deactivated.

For further information, please contact your MITSUBISHI MOTORS Authorised Service Point.

On vehicles equipped with Mitsubishi Multi-Communication System (MMCS), screen operations can be used to make the adjustment. Refer to the separate owner's manual for details.

6

Headlamp levelling

E00517400103

Headlamp levelling switch*

E00517500612

Except for vehicles with discharge headlamps

The direction of the headlamp beam (the direction which the light shines in) alters according to the number of people and the load in the vehicle. Lower the headlamp

6-44 Instruments and controls

angle if it is too high due to the number of people and/or the load in the vehicle so that the headlamps' glare does not distract the drivers of approaching vehicles. First set the light switch to the “” position, then turn the headlamp levelling switch knob to lower the beam. The greater the number on the headlamp levelling switch knob, the lower the beam will point.

Set the switch to the appropriate position so that the headlamp beam is level with the road.

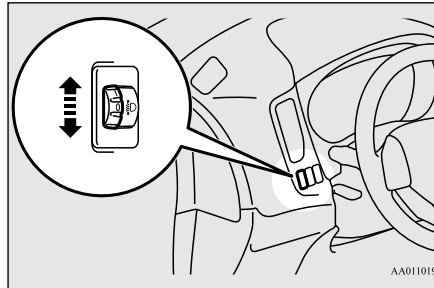

CAUTION

- Always perform adjustments before driving. Do not attempt to adjust while driving, as it could cause an accident.

NOTE

- Start adjusting when the knob is at the “0” position (when the beam is at its highest).
- Keep the knob in the “0” position except when using the knob to lower the headlamp beam angle.
- Always return the knob to the “0” position when the baggage is removed and the people have left the vehicle.

Automatic headlamp levelling*

E00517601551

Vehicles with discharge headlamps

This mechanism automatically adjusts the direction of the headlamps (beam position) depending on changes in the condition of the vehicle, such as the number of occupants or luggage weight. When the headlamps are illuminated with the operation mode in ON, the beam position of the headlamps is automatically adjusted when the vehicle is stopped.

Turn-signal lever

E00506502645

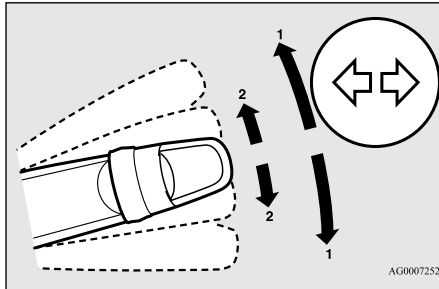

AG0007252

1- Turn-signals

When making a normal turn, use position (1). The lever will return automatically when cornering is completed.

2- Lane-change signals

When moving the lever to (2) slightly to change a lane, the turn-signal lamps and indicator lamp in the instrument cluster will only flash while the lever is operated.

Also, when you move the lever to (2) slightly then release it, the turn-signal lamps and indicator lamp in the instrument cluster will flash three times.

NOTE

- If the lamp flashes unusually quickly, the bulb in a turn-signal lamp may have burned out. We recommend you to have the vehicle inspected.
- It is possible to activate the following functions:
 - Flashing of the turn-signal lamps when the lever is operated with the operation mode is in ACC.
 - Deactivate the turn-signal lamp 3-flash function for lane changes
 - The time required to operate the lever for the 3-flash function can be adjusted.

For further information, we recommend you to consult a MITSUBISHI MOTORS Authorised Service Point.

On vehicles equipped with Mitsubishi Multi-Communication System (MMCS), screen operations can be used to make the adjustment. Refer to the separate owner's manual for details.

- It is possible to change the tone of a sounding buzzer as the turn-signal lamps flash. Refer to "Changing the turn-signal sound" on page 6-20.

Turn-signal lever

Hazard warning flasher switch

E00506602024

Use the hazard warning flasher switch when the vehicle has to be parked on the road for any emergency.

The hazard warning flashers can always be operated, regardless of the operation mode.

6

Push the switch to turn on the hazard warning flashers, all turn signal lamps flash continuously. To turn them off, push the switch again.

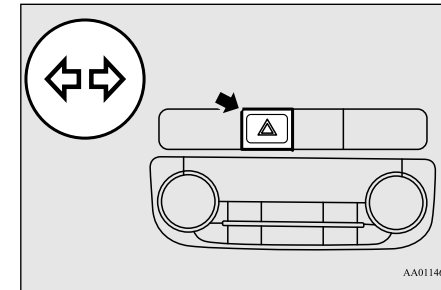

AA0114664

NOTE

- If the switch is used for a long period while the ready indicator is not illuminated, the auxiliary battery could go flat and the Plug-in Hybrid EV System could be impossible to start.

ECO mode switch

NOTE

- On vehicles equipped with the emergency stop signal system, while the hazard warning lamps are blinking due to having manually pushed the switch, the emergency stop signal system does not operate. Refer to “Emergency stop signal system” on page 7-29.

6

ECO mode switch

E00531801049

ECO mode is an eco-driving support system which automatically controls the Plug-in Hybrid EV System and air conditioning system to improve fuel efficiency. Refer to “Automatic climate control air conditioner” on page 8-4.

The ECO mode starts working by pressing the ECO mode switch when operation mode of the power switch is in ON. Push the switch again and the ECO mode will cancel. While the ECO mode is working, an ECO mode indicator will be turned on.

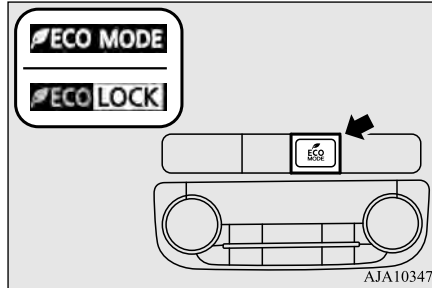

NOTE

- Even if the ECO mode is operating, you can select normal operation of the air conditioner. For further information, we recommend you to consult a MITSUBISHI MOTORS Authorised Service Point. On vehicles equipped with Mitsubishi Multi-communication System (MMCS), it is possible to change the setting by means of screen operations. Refer to the separate owner's manual for details.

Fog lamp switch

E00506700034

Front fog lamp switch

E00508301741

The front fog lamps can be operated while the headlamps or tail lamps are on. Turn the knob in the “ON” direction to turn on the front fog lamps. An indicator lamp in the instrument cluster will also come on. Turn the knob in the “OFF” direction to turn off the front fog lamps. The knob will automatically return to its original position when you release it.

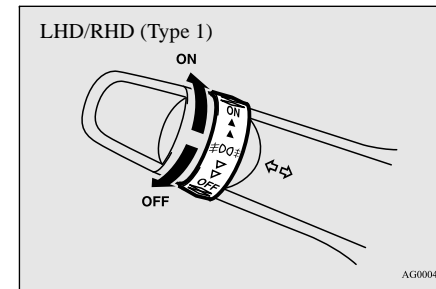

Wiper and washer switch

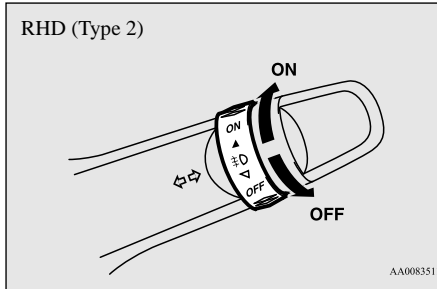

Turn the knob once in the “ON” direction to turn on the front fog lamps. Turn the knob once more in the “ON” direction to turn on the rear fog lamp. To turn the rear fog lamp off, turn the knob once in the “OFF” direction. Turn the knob once more in the “OFF” direction to turn off the front fog lamps. The knob will automatically return to its original position when you release it.

Wiper and washer switch

E00507101218

CAUTION

- If the washer is used in cold weather, the washer fluid sprayed against the glass may freeze, which may hinder visibility. Warm the glass with the defroster or rear window demister before using the washer.

6

NOTE

- The front fog lamps are automatically turned off when the headlamps or tail lamps are turned off. To turn the front fog lamps on again, turn the knob in the “ON” direction after turning on the headlamps or tail lamps.
- Do not use fog lamps except in conditions of fog, otherwise excessive lamp glare may temporarily blind oncoming vehicle drivers.

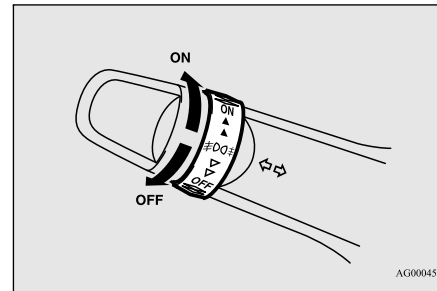

Windscreen wipers

E00516901687

NOTE

- To ensure a clear rearward view, the rear window wiper will automatically perform several continuous operations if the selector lever is put in the “R” position while the windscreen wipers are operating. Refer to “Rear window wiper and washer” on page 6-51.

Rear fog lamp switch*

E00508401612

The rear fog lamp can be operated when the headlamps or front fog lamps turn on. An indicator lamp in the instrument cluster comes on when the rear fog lamp is turned on.

NOTE

- The rear fog lamp is automatically turned off when the headlamps or front fog lamps are turned off.
- To turn the rear fog lamp on again, turn the knob twice in the “ON” direction after turning on the headlamps.

Except for vehicles equipped with rain sensor

The windscreen wipers can be operated with the operation mode of the power switch in ON or ACC.

If the blades are frozen to the windscreen or rear window, do not operate the wipers until

Wiper and washer switch

the ice has melted and the blades are freed, otherwise the wiper motor may be damaged.

6

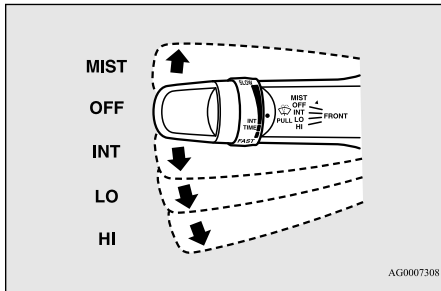

- MIST- Misting function
The wipers will operate once.
- OFF- Off
- INT- Intermittent (Speed sensitive)
- LO- Slow
- HI- Fast

To adjust intermittent intervals

With the lever in the “INT” (speed-sensitive) position, the intermittent intervals can be adjusted by turning the knob (A).

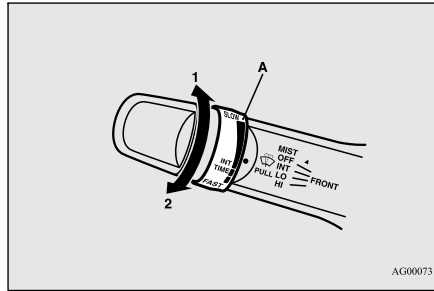

- 1- Fast
- 2- Slow

NOTE

- The speed-sensitive-operation function of the windscreen wipers can be deactivated. For further information, we recommend you to consult a MITSUBISHI MOTORS Authorised Service Point. On vehicles equipped with Mitsubishi Multi-Communication System (MMCS), screen operations can be used to make the adjustment. Refer to the separate owner’s manual for details.

Misting function

The misting function can be operated with the operation mode of the power switch in ON or ACC.

The wipers will operate once if the wiper lever is raised to the “MIST” position and released. This operation is useful when it is drizzling, etc. The wipers will continue to operate while the lever is held in the “MIST” position.

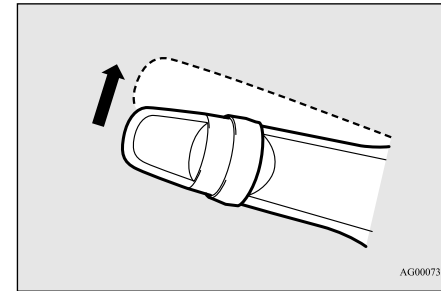

Vehicles equipped with rain sensor

E00517001409

The windscreen wipers can be operated with the operation mode of the power switch in ON or ACC.

If the blades are frozen to the windscreen or rear window, do not operate the wipers until the ice has melted and the blades are freed, otherwise the wiper motor may be damaged.

Wiper and washer switch

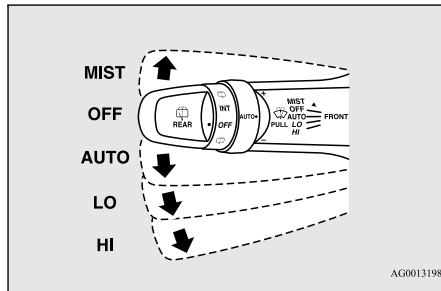

- MIST-** Misting function
The wipers will operate once.
- OFF-** Off
- AUTO-** Auto-wiper control
Rain sensor
The wipers will automatically operate depending on the degree of wetness on the windscreen.
- LO-** Slow
- HI-** Fast

Rain sensor

Can only be used when the operation mode of the power switch is in ON.

If the lever is put in the “AUTO” position, the rain sensor (A) will detect the extent of rain (or snow, other moisture, dust, etc.) and the wipers will operate automatically.

Keep the lever in the “OFF” position if the windscreen is dirty and the weather is dry.

Wiper operation under these conditions can scratch the windscreen and damage the wipers.

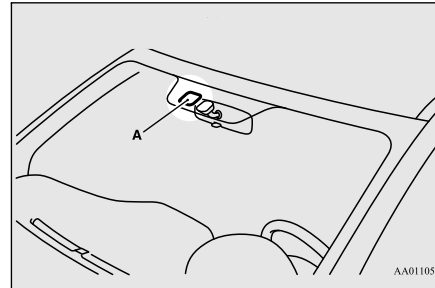

CAUTION

- With the operation mode in ON and lever in the “AUTO” position, the wipers may automatically operate in the situations described below.
If your hands get trapped, you could suffer injuries or the wipers could malfunction. Be sure to put the operation mode in OFF, or move lever to the “OFF” position to deactivate the rain sensor.
- When cleaning the outside surface of the windscreen, if you touch on top of the rain sensor.
- When cleaning the outside surface of the windscreen, if you wipe with a cloth on top of the rain sensor.
- When using an automatic car wash.

CAUTION

- A physical shock is applied to the windscreen.
- A physical shock is applied to the rain sensor.

NOTE

- To protect the rubber parts of the wipers, this operation of the wipers does not take place when the vehicle is stationary and the ambient temperature is about 0 °C or lower.
- Do not cover the sensor by affixing a sticker or label to the windscreen. Also, do not put any water-repellent coating on the windscreen. The rain sensor would not be able to detect the extent of rain, and the wipers might stop working normally.
- In the following cases, the rain sensor may be malfunctioning.
For further information, we recommend you to consult a MITSUBISHI MOTORS Authorised Service Point.
 - When the wipers operate at a constant interval despite changes in the extent of rain.
 - When the wipers do not operate even though it is raining.

Wiper and washer switch

NOTE

- The wipers may automatically operate when things such as insects or foreign objects are affixed to the windscreen on top of the rain sensor or when the windscreen is frozen. Objects affixed to the windscreen will stop the wipers when the wipers cannot remove them. To operate the wipers again, move the lever in the “LO” or “HI” position. Also, the wipers may operate automatically due to strong direct sunlight or electromagnetic wave. To stop the wipers, place the lever in the “OFF” position.
- Contact a MITSUBISHI MOTORS Authorised Service Point when replacing the windscreen or reinforcing the glass around the sensor.

6

To adjust the sensitivity of the rain sensor

With the lever in the “AUTO” (rain sensor) position, it is possible to adjust the sensitivity of the rain sensor by turning the knob (B).

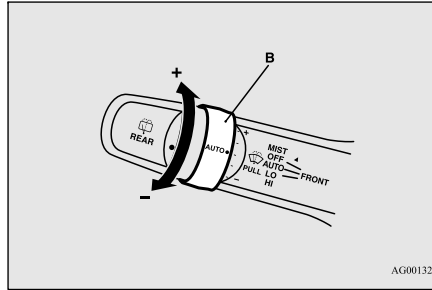

- “+”- Higher sensitivity to rain
- “-”- Lower sensitivity to rain

NOTE

- It is possible to activate the following functions:
 - Automatic operation (rain droplet sensitive) can be changed to intermittent operation (vehicle-speed sensitive).
 - Automatic operation (rain droplet sensitive) can be changed to intermittent operation (except vehicle-speed sensitive).
- For further information, we recommend you to consult a MITSUBISHI MOTORS Authorised Service Point.
- On vehicles equipped with Mitsubishi Multi-Communication System (MMCS), screen operations can be used to make the adjustment. Refer to the separate owner’s manual for details.

Misting function

Move the lever in the direction of the arrow and release, to operate the wipers once.

Use this function when you are driving in mist or drizzle.

The wipers will operate once if the lever is raised to the “MIST” position and released when the operation mode of the power switch is in ON or ACC. The wipers will continue to operate while the lever is held in the “MIST” position.

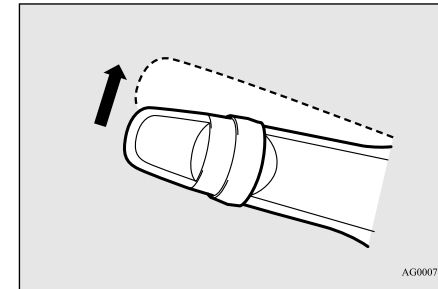

The wipers will operate once if the lever is moved to the “AUTO” position and the knob (C) is turned in the “+” direction when the operation mode is in ON.

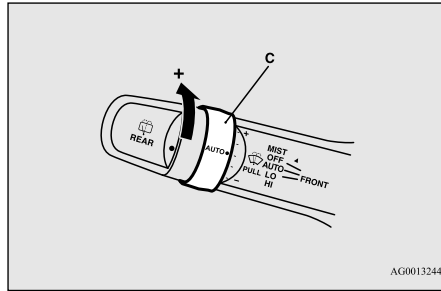

AG0013244

Windscreen washer

E00507202317

The windscreen washer can be operated with the operation mode of the power switch in ON or ACC.

The washer fluid will be sprayed onto the windscreen by pulling the lever towards you. When the wipers are not in operation or in intermittent operation, by pulling the lever towards you, the wipers will operate several times while the washer fluid is being sprayed. Except for vehicles for Russia, Kazakhstan and Ukraine, then about 6 seconds later, wipers operate once more.

On vehicles equipped with the headlamp washer, while the headlamps are on, the headlamp washer will operate once together with the windscreen washer.

Also, except for vehicles for Russia, Kazakhstan and Ukraine, by releasing the lever soon after pulling it towards you, the washer fluids will be sprayed several times while the wipers are operating several times. (Intelligent washer) Then about 6 seconds later, wipers operate once more. Intelligent washer will stop operating with any operation of the lever.

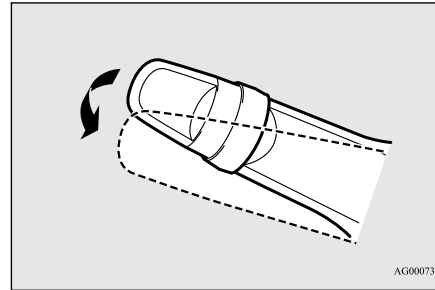

AG0007337

CAUTION

- If the washer is used in cold weather, the washer fluid sprayed against the glass may freeze resulting in poor visibility. Heat the glass with the defroster or demister before using the washer.

NOTE

- It is possible to modify functions as follows:

Wiper and washer switch

NOTE

- Causing the wiper never to operate when washer fluid is sprayed.
- Except for vehicles for Russia, Kazakhstan and Ukraine, deactivating the intelligent washer.
- Except for vehicles for Russia, Kazakhstan and Ukraine, deactivating the function that operates the wipers once more about 6 seconds later.
- Vehicles for Russia, Kazakhstan and Ukraine, activating the intelligent washer
- Vehicles for Russia, Kazakhstan and Ukraine, the wipers can be set to operate again after about 6 seconds.

For further information, we recommend you to consult a MITSUBISHI MOTORS Authorised Service Point.

On vehicles equipped with Mitsubishi Multi-Communication System (MMCS), screen operations can be used to make the adjustment. Refer to the separate owner's manual for details.

6

Rear window wiper and washer

E00507302376

The rear window wiper and washer switch can be operated with the operation mode of the power switch in ON or ACC.

Wiper and washer switch

6

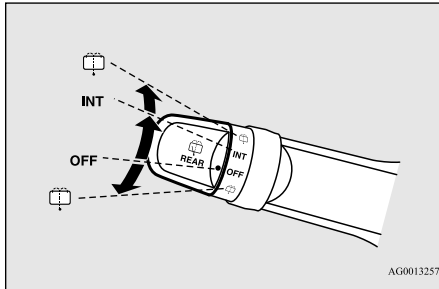

INT - The wiper operates continuously for several seconds then operates intermittently at intervals of about every 8 seconds

OFF - Off
 The washer fluid will be sprayed onto the rear window when the knob is turned fully in either direction.

The wipers operate automatically several times while the washer fluid is being sprayed

NOTE

- The rear window wiper will automatically perform several continuous operations if the selector lever is put in the “R” position while the windscreen wipers or the rear window wiper is operating. (automatic operation mode)

After the automatic operation, the rear window wiper will stop operating if the knob is in the “OFF” position. If the knob is in the “INT” position, the rear window wiper will return to the intermittent operation.

It is possible to set the rear window wiper to perform the automatic operation only if the selector lever is put in the “R” position while the rear window wiper is operating with the knob in the “INT” position.

For further information, we recommend you to consult a MITSUBISHI MOTORS Authorised Service Point.

- If the knob is in the “OFF” position, turn the knob to the “INT” position twice quickly to operate the rear window wiper continuously. (continuous operation mode)
 Turn the knob to the “OFF” position to stop the rear window wiper continuous operation.

NOTE

- The interval for intermittent operation can be adjusted.

For further information, we recommend you to consult a MITSUBISHI MOTORS Authorised Service Point.

On vehicles equipped with Mitsubishi Multi-Communication System (MMCS), screen operations can be used to make the adjustment. Refer to the separate owner’s manual for details.

Headlamp washer switch*

E00510101384

The headlamp washer can be operated with the operation mode in ON or ACC and the lamp switch at the “ ” position.

Push the button once and the washer fluid will be sprayed on to the headlamps.

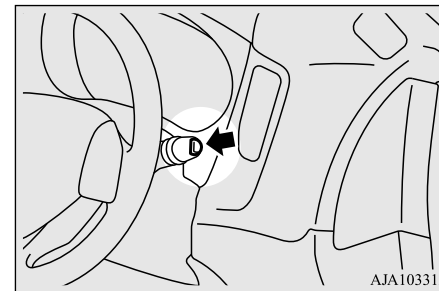

NOTE

- If the operation mode is in ON or ACC and the headlamps are on, the headlamp washer operates together with the windscreen washer the first time the windscreen washer lever is pulled.

Precautions to observe when using wipers and washers

E00507601167

- If the moving wipers become blocked by ice or other deposits on the glass, the motor may burn out even if the wiper switch is turned to OFF. If obstruction occurs, park your vehicle in a safe place, stop the Plug-in Hybrid EV System, and clean the deposits from the glass so that the wipers operate smoothly.
- Do not use the wipers when the glass is dry. They may scratch the glass surface and the blades wear out prematurely.
- Before using the wipers in cold weather, check that the wiper blades are not frozen onto the glass. The motor may burn out if the wipers are used with the blades frozen onto the glass.
- Avoid using the washer continuously for more than 20 seconds. Do not operate the washer when the fluid reservoir is empty. Otherwise, the motor may burn out.

- Periodically check the level of washer fluid in the reservoir and refill if required. During cold weather, add a recommended washer solution that will not freeze in the washer reservoir. Failure to do so could result in loss of washer function and frost damage to the system components.

Wiper deicer switch*

E00507701142

The rear window demister switch can be operated when the Plug-in Hybrid EV System is operating.

When the front wipers have frozen to the windscreen at the parked positions, turning on this switch will heat the windscreen to make the wipers operable. Press the rear window demister switch and the deicer will operate.

NOTE

- The wiper deicer is activated/deactivated, depending on the operation of the rear window demister. Refer to "Rear window demister switch" on page 6-53.

Wiper deicer switch***Rear window demister switch**

E00507902284

The rear window demister switch can be operated when the operation mode of the power switch is in ON.

Push the switch to turn on the rear window demister. It will be turned off automatically in about 15 to 20 minutes depending on the outside temperature. To turn off the demister while it is operating, push the switch again. The indicator lamp (A) will illuminate while the demister is on.

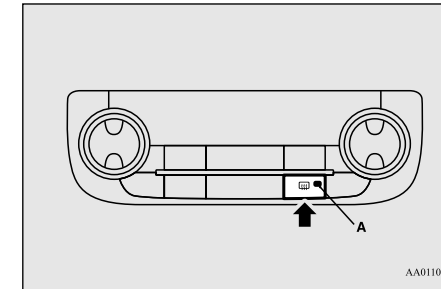
6

AA0110220

NOTE

- Do not use this switch when the ready indicator lamp is not illuminated. The auxiliary battery could go flat, making it impossible to start the Plug-in Hybrid EV System.

Horn switch

6

NOTE

- Since the demister requires a significant amount of power, stop the demister as soon as the window is demisted. Using it for a long time may reduce the auxiliary battery voltage, making it impossible to start the Plug-in Hybrid EV System.
- On vehicles equipped with heated mirrors, when the rear window demister switch is pressed, the outside rear-view mirrors are defogged or defrosted. Refer to “Heated mirror” on page 7-9.
- On vehicles equipped with the wiper deicer, when the rear window demister switch is pushed, the window glass becomes warm and the wipers become operable. Refer to “Wiper deicer switch” on page 6-53.

NOTE

- It is possible to change the setting to make the rear window demister operate automatically when ambient temperature becomes low while the ready indicator lamp is illuminated, even if you do not push the rear window demister switch.
It operates automatically only once after putting the operation mode in ON.
If you choose this setting, the heated mirrors (if so equipped) and wiper deicer (if so equipped) will also operate automatically at the same time.
For further information, we recommend you to consult a MITSUBISHI MOTORS Authorised Service Point.
On vehicles equipped with Mitsubishi Multi-Communication System (MMCS), screen operations can be used to make the adjustment. Refer to the separate owner’s manual for details.
- The demister switch is not to melt snow but to clear mist. Remove snow before use of the demister switch.
- When cleaning the inside of the rear window, use a soft cloth and wipe lightly along the heater wires, being careful not to damage the wires.
- Do not allow objects to touch the inside of the rear window glass, damaged or broken wires may result.

Horn switch

E00508000640

Press the steering wheel on or around the “” mark.

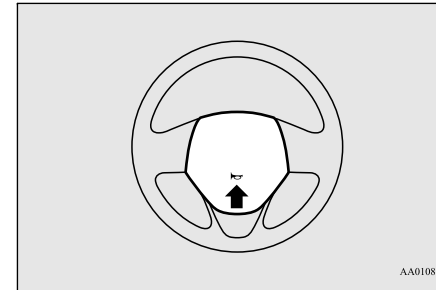

Starting and driving

Economical driving.....	7-2	Active stability control (ASC).....	7-32
Driving, alcohol and drugs	7-2	Cruise control *	7-35
Floor mat *	7-3	Speed Limiter *	7-39
Safe driving techniques.....	7-4	Adaptive Cruise Control System (ACC) *	7-43
Parking brake	7-4	Forward Collision Mitigation System (FCM) *	7-55
Parking	7-5	Lane Departure Warning (LDW) *	7-60
Steering wheel height and reach adjustment.....	7-6	Reversing sensor system *	7-63
Inside rear-view mirror	7-6	Rear-view camera *	7-67
Outside rear-view mirrors.....	7-7	Cargo loads	7-70
Power switch.....	7-10	Towing caravans and trailers	7-71
Starting and stopping the Plug-in Hybrid EV System	7-12		
Selector Lever (Joystick Type)	7-14		
Select Position indicator	7-15		
Electrical Parking switch	7-16		
Regenerative braking level selector (paddle) *	7-17		
S-AWC (Super All Wheel Control)	7-18		
4-wheel drive operation	7-20		
Inspection and maintenance following rough road operation.....	7-21		
Cautions on the handling of 4-wheel drive vehicles.....	7-22		
Battery save switch	7-22		
Battery charge switch.....	7-23		
Acoustic Vehicle Alerting System (AVAS)	7-24		
Braking	7-26		
Hill start assist.....	7-27		
Brake assist system	7-28		
Emergency stop signal system *	7-29		
Anti-lock brake system (ABS).....	7-29		
Electric power steering system (EPS).....	7-32		

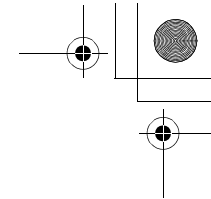

Economical driving

Economical driving

E00600102220

For economical driving, there are some technical requirements that have to be met. The prerequisite for low fuel consumption is a properly adjusted engine. In order to achieve longer life of the vehicle and the most economical operation, we recommend you to have the vehicle checked at regular intervals in accordance with the service standards.

7

Fuel economy and generation of exhaust gas and noise are highly influenced by personal driving habits as well as the particular operating conditions. The following points should be observed in order to minimize wear of brakes, tyres and engine as well as to reduce environmental pollution.

Starting and acceleration

Avoid driving where the accelerator pedal is pushed way down, such as for unnecessarily sudden starts, acceleration and deceleration. Smoothly depress the accelerator pedal. Observe the speed limit and keep the speed as constant as possible while driving.

Idling

Parking for a long period with the ready indicator illuminated will shorten the cruising range.

Speed

At higher the vehicle speed, more drive battery is consumed. Avoid driving at full speed. Even a slight release of the accelerator pedal will save a significant amount of drive battery.

Tyre inflation pressure

Check the tyre inflation pressures at regular intervals. Low tyre inflation pressure increases road resistance and fuel consumption. In addition, low tyre pressures adversely affect tyre wear and driving stability.

Cargo loads

Do not drive with unnecessary articles in the luggage compartment. Especially during city driving where frequent starting and stopping is necessary, the increased weight of the vehicle will greatly affect fuel consumption. Also

avoid driving with unnecessary luggage or carriers, etc., on the roof; the increased air resistance will increase fuel consumption.

Air conditioning

Too much cooling/heating can affect the cruising range, so maintain an appropriate temperature to extend the cruising range.

Driving, alcohol and drugs

E00600200070

Drunk driving is one of the most frequent causes of accidents.

Your driving ability can be seriously impaired even with blood alcohol levels far below the legal minimum. If you have been drinking, don't drive. Ride with a designated non-drinking driver, call a cab or a friend, or use public transportation. Drinking coffee or taking a cold shower will not make you sober.

Similarly, prescription and nonprescription drugs affect your alertness, perception and reaction time. Consult with your doctor or pharmacist before driving while under the influence of any of these medications.

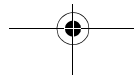

Floor mat*

⚠ WARNING

- **NEVER DRINK AND DRIVE.**
Your perceptions are less accurate, your reflexes are slower and your judgment is impaired.

Floor mat*

E00631401118

The original equipment floor mat provided with your vehicle was specifically designed for your vehicle.

Always properly position the floor mat and assure it does not interfere with operation of the pedals. Always use the retaining clip on the driver's floorboard to secure the floor mat. When used, this clip will help prevent the floor mat from moving forward and possibly interfering with the operation of the pedals. To prevent the floor mat from moving forward and possibly interfering with the operation of the pedals, MITSUBISHI MOTORS GENUINE floor mats are recommended.

To install the floor mat

E00631501089

1. Place the floor mat to fit the shape of the floorboard.
2. Align the floor mat with the installation holes over the retaining clips.

3. Secure the floor mat with retaining clips

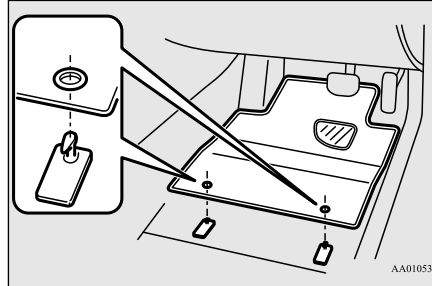

NOTE

- The shape of the mat and the number of retaining clips may vary depending on the vehicle model.

⚠ WARNING

- If a floor mat is the wrong size or is not properly installed, it can interfere with the operation of the pedals. Interference with the pedals can cause unintended acceleration and/or increased stopping distances resulting in a crash and injury. Always make sure the floor mat does not interfere with the accelerator or brake pedal.
- Always use the retaining clip on the driver's floorboard to secure the floor mat.
- Always install the mat with the correct side facing down.

⚠ WARNING

- Never install a second mat over or under an existing floor mat.
- Do not use a floor mat designed for another model vehicle even if it is a MITSUBISHI MOTORS GENUINE floor mat.
- Before driving, be sure to check the following:
 - Periodically check that the floor mat is properly secured with all retaining clips. When you remove the floor mat while cleaning the inside of your vehicle and other reasons, always check the condition after the floor mat is installed.
 - While the vehicle is stopped with the engine is not running, check the floor mat is not interfering with the pedals by depressing the all pedals fully.

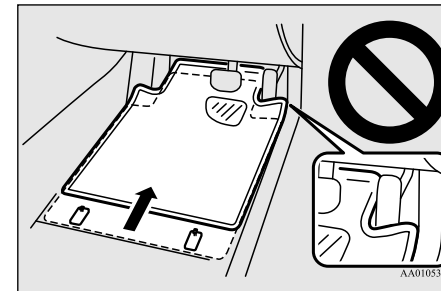

Safe driving techniques

Safe driving techniques

E00600301788

Driving safety and protection against injury cannot be fully ensured. However, we recommend that you pay extra attention to the following:

Seat belts

- 7** Before starting the vehicle, make sure that you and your passengers have fastened your seat belts.

Carrying children in the vehicle

- Never leave your vehicle unattended with the key and children inside the vehicle. Children may play with the driving controls and this could lead to an accident.
- Make sure that infants and small children are properly restrained in accordance with the laws and regulations, and for maximum protection in case of an accident.
- Prevent children from playing in the luggage compartment. It is quite dangerous to allow them to play there while the vehicle is moving.

Loading luggage

When loading luggage, be careful not to load above the height of seats. This is dangerous not only because rearward vision will be obstructed, but also the luggage may be projected into the passenger compartment under hard braking.

Parking brake

E00600502774

To park the vehicle, first bring it to a complete stop, fully apply the parking brake sufficiently to hold the vehicle.

To apply

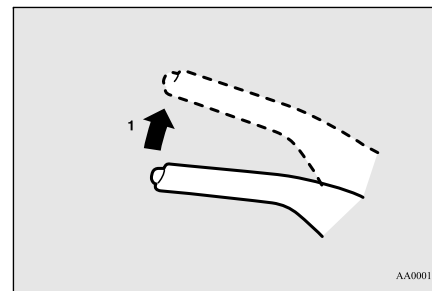

- 1- Firmly depress and hold the brake pedal, then pull the lever up without pushing the button at the end of hand grip.

CAUTION

- When you intend to apply the parking brake, firmly press the brake pedal to bring the vehicle to a complete stop before pulling the parking brake lever. Pulling the parking brake lever with the vehicle moving could make the rear wheels lock up, thereby making the vehicle unstable. It could also make the parking brake malfunction.

Parking

NOTE

- Apply sufficient force to the parking brake lever to hold the vehicle stationary after the foot brake is released.
- If the parking brake does not hold the vehicle stationary after the foot brake is released, have your vehicle checked immediately.

To release

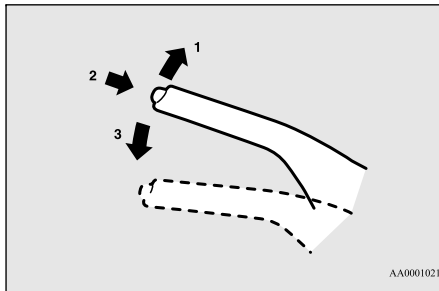

- 1- Firmly depress and hold the brake pedal, then pull the lever up slightly.
- 2- Push the button at the end of hand grip.
- 3- Lower the lever fully.

CAUTION

- Before driving, be sure that the parking brake is fully released and brake warning lamp is off. If you drive without the parking brake fully released, the warning display will appear on the information screen in the multi information display and a buzzer sound when the vehicle speed exceeds 8 km/h. If a vehicle is driven without releasing the parking brake, the brake will be overheated, resulting in ineffective braking and possible brake failure.

Warning lamp



Warning display



- If the brake warning lamp does not extinguish when the parking brake is fully released, the brake system may be abnormal. Have your vehicle checked immediately. For details, refer to “Brake warning lamp” on page 6-37.

Parking

E00600602645

To park the vehicle, fully engage the parking brake, and then press the electrical parking switch to lock the wheels.

Parking on a hill

To prevent the vehicle from rolling, follow these procedures:

7

Parking on a downhill slope

Turn the front wheels towards the kerb and move the vehicle forward until the kerb side wheel gently touches the kerb.

Apply the parking brake and press the electrical parking switch.

If necessary, apply chocks to wheels.

Parking on an uphill slope

Turn the front wheels away from the kerb and move the vehicle back until the kerb side wheel gently touches the kerb.

Apply the parking brake and press the electrical parking switch.

If necessary, apply chocks to wheels.

Steering wheel height and reach adjustment

Parking with the engine running

Never leave the engine running while you take a short sleep/rest. Also, never leave the engine running in a closed or poorly ventilated place.

WARNING

- Leaving the engine running risks injury or death from accidentally moving the selector lever or the accumulation of toxic exhaust fumes on the passenger compartment.

Where you park

WARNING

- Do not park your vehicle in areas where combustible materials such as dry grass or leaves can come in contact with a hot exhaust, since a fire could occur.

When leaving the vehicle

Always carry the key and lock all doors and the tailgate when leaving the vehicle unattended.

7-6 Starting and driving

Always try to park your vehicle in a well lit area.

CAUTION

- When you leave the vehicle, be sure to stopped the Plug-in Hybrid EV System. The engine may be start suddenly by a remaining amount decline of the drive battery.

Steering wheel height and reach adjustment

E00600700567

1. Release the lever while holding the steering wheel up.
2. Adjust the steering wheel to the desired position.
3. Securely lock the steering wheel by pulling the lever fully upward.

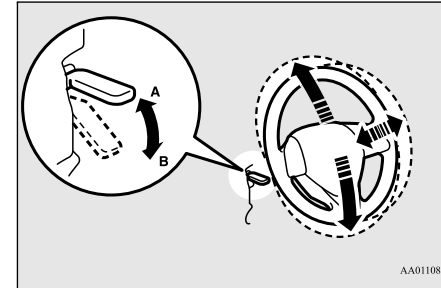

AA0110800

- A- Locked
- B- Release

WARNING

- Do not attempt to adjust the steering wheel while you are driving the vehicle.

Inside rear-view mirror

E00600800832

Adjust the rear-view mirror only after making any seat adjustments so you have a clear view to the rear of the vehicle.

WARNING

- Do not attempt to adjust the rear-view mirror while driving. This can be dangerous. Always adjust the mirror before driving.

Outside rear-view mirrors

Adjust the rear-view mirror to maximize the view through the rear window.

To adjust the vertical mirror position

It is possible to move the mirror up and down to adjust its position.

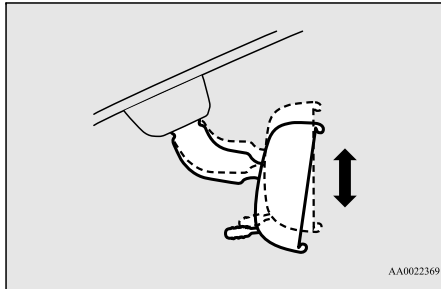

To adjust the mirror position

It is possible to move the mirror up/down and left/right to adjust its position.

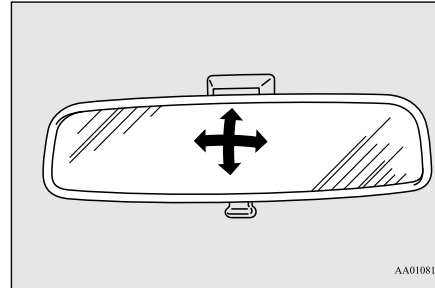

To reduce the glare

The lever (A) at the bottom of the mirror can be used to adjust the mirror to reduce the glare from the headlamps of vehicles behind you during night driving.

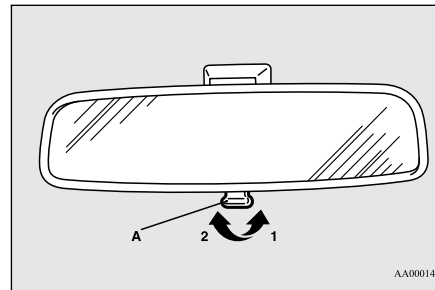

- 1- Normal
- 2- Anti-glare

Outside rear-view mirrors

E00600900628

To adjust the mirror position

E00601001740

The outside rear-view mirrors can be operated when the operation mode is put in ON or ACC.

⚠ WARNING

- Do not attempt to adjust the rear-view mirrors while driving. This can be dangerous. Always adjust the mirrors before driving.
- Your vehicle is equipped with convex type mirrors. Please take into consideration, but objects you see in the mirror will look smaller and farther away compared to a normal flat mirror. Do not use this mirror to estimate distance of following vehicles when changing lanes.

7

Outside rear-view mirrors

1. Place the lever (A) to the same side as the mirror whose adjustment is desired.

7

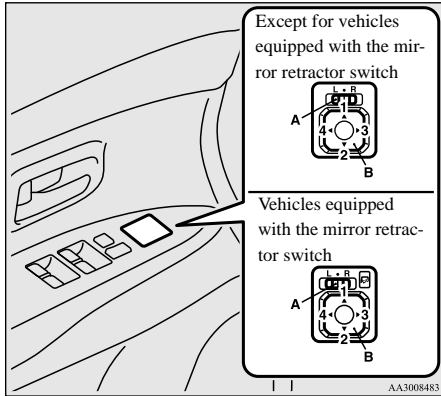

L- Left outside mirror adjustment
R- Right outside mirror adjustment

2. Press the switch (B) to the left, right, up or down to adjust the mirror position.

- 1-Up
- 2-Down
- 3-Right
- 4-Left

3. Return the lever (A) back to the middle position (•).

Retracting and extending the outside mirrors

E00601101741

The outside mirror can be folded in towards the side window to prevent damage when parking in narrow areas.

CAUTION

- Do not drive the vehicle with the mirror folded in. The lack of rearward visibility normally provided by the mirror could lead to an accident.

Except for vehicles equipped with the mirror retractor switch

Push the mirror towards the back of the vehicle with your hand to retract it in. When extending the mirror, pull it out towards the front of the vehicle until it clicks to lock in place.

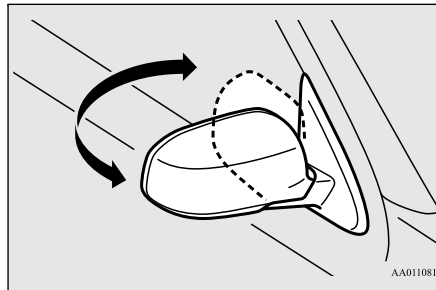

For vehicles equipped with the mirror retractor switch

Retracting and extending the mirrors using the mirror retractor switch

With the operation mode in ON or ACC, push the mirror retractor switch to retract the mirrors. Push it again to extend the mirrors to their original positions. After placing the operation mode in OFF, it is possible to retract and extend the mirrors using the mirror retractor switch for about 30 seconds.

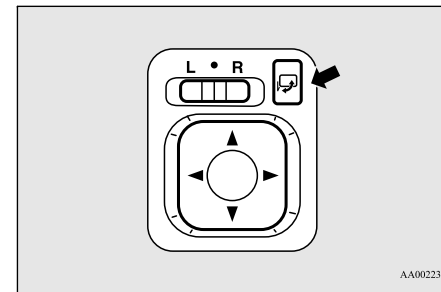

Outside rear-view mirrors

CAUTION

- It is possible to retract and extend the mirrors by hand. After retracting a mirror using the mirror retractor switch, however, you should extend it by using the switch again, not by hand. If you extended the mirror by hand after retracting it using the switch, it would not properly lock in position. As a result, it could move because of the wind or vibration while you are driving, taking away your rearward visibility.

NOTE

- Be careful not to get your hands trapped while a mirror is moving.
- If you move a mirror by hand or it moves after hitting a person or object, you may not be able to return it to its original position using the mirror retractor switch. If this happens, push the mirror retractor switch to place the mirror in its retracted position and then push the switch again to return the mirror to its original position.
- When freezing has occurred and mirrors fail to operate as intended, please refrain from repeated pushing of the retractor switch as this action can result in burn-out of the mirror motor circuits.

Retracting and extending the mirrors without using the mirror retractor switch

The mirrors automatically retract or extend when the doors are locked or unlocked using the remote control switches or the keyless operation function of the keyless operation system.

Refer to “Keyless operation system: To operate using the key-less operation function, Keyless entry system” on pages 4-9.

NOTE

- Functions can be modified as stated below. Please consult a MITSUBISHI MOTORS Authorised Service Point. On vehicles equipped with Mitsubishi Multi-Communication System (MMCS), screen operations can be used to make the adjustment. Refer to the separate owner’s manual for details.
 - Automatically extend when the operation mode is put in ON, and automatically retract when the driver’s door is opened after the operation mode is put in OFF.
 - Automatically extend when the vehicle speed reaches 30 km/h.
 - Deactivate the automatic extension function.

Heated mirror*

E00601201582

To demist or defrost the outside rear-view mirrors, press the rear window demister switch.

The indicator lamp (A) will illuminate while the demister is on.

The heater will be turned off automatically in about 15 to 20 minutes depending on the outside temperature.

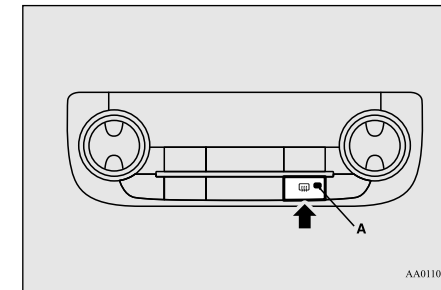
7

Power switch

NOTE

- The heater mirrors can be turned on automatically. For further information, we recommend you to consult a MITSUBISHI MOTORS Authorised Service Point. On vehicles equipped with Mitsubishi Multi-Communication System (MMCS), screen operations can be used to make the adjustment. Refer to the separate owner's manual for details.

7

Power switch

E00631801079

In order to prevent theft, the Plug-in Hybrid EV System will not start unless a preregistered keyless operation key is used. (Immobilizer function)

If you are carrying the keyless operation key, you can start the Plug-in Hybrid EV System.

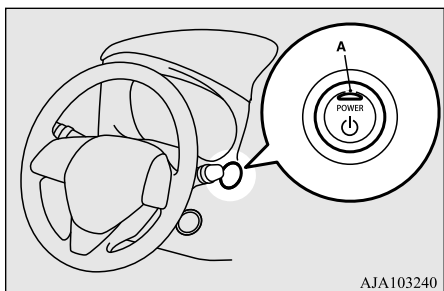

AJA103240

CAUTION

- The indicator lamp (A) will flash orange when there is a problem or malfunction in the keyless operation system. Never drive if the indicator lamp on the power switch is flashing orange. Immediately contact a MITSUBISHI MOTORS Authorised Service Point.
- If the power switch operation is not smooth and feels like it is sticking, do not operate the switch. Immediately contact a MITSUBISHI MOTORS Authorised Service Point.

NOTE

- When operating the power switch, press the switch all the way in. If the switch is not fully pressed, the Plug-in Hybrid EV System may not start or the operation mode may not change. If the power switch is pressed correctly, there is no need to hold the power switch down.
- When the battery in the keyless operation system key has worn out, and taking the keyless operation key out of the vehicle, a warning lamp will blink for 5 seconds or warning display will appear.



Operation mode of the power switch and its function

OFF

The indicator lamp on the power switch turns off.

The operation mode cannot be put in OFF unless the electrical parking switch is pressed.

ACC

Electrical devices such as the audio and accessory socket can be operated. Can be used when the Ready indicator is off.

The indicator lamp on the power switch illuminates orange.

ON

All vehicle's electrical devices can be operated.

The indicator lamp on the power switch illuminates blue. The indicator lamp turns off when the Plug-in Hybrid EV System is operating.

Power switch

NOTE

- Your vehicle is equipped with an electronic immobilizer. To start the Plug-in Hybrid EV System, the ID code which the transponder inside the key sends must match the one registered in the immobilizer computer. Refer to "Electronic immobilizer (Anti-theft starting system)" on page 4-3.

Changing the operation mode

E00631901041

If you press the power switch without depressing the brake pedal, you can change the operation mode in the order of OFF, ACC, ON, OFF.

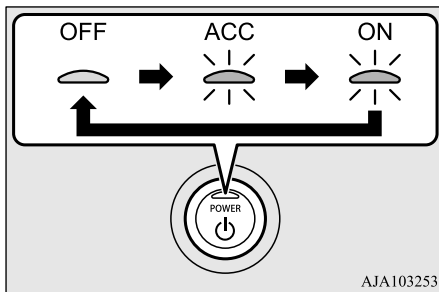

AJA103253

CAUTION

- When the Plug-in Hybrid EV System is not operating, put the operation mode in OFF. Leaving the operation mode in ON or ACC for a long time when the Plug-in Hybrid EV System is not operating may cause the auxiliary battery to be discharged, making it impossible to start the Plug-in Hybrid EV System.
- When the auxiliary battery is disconnected, the current operation mode is memorized. After reconnecting the auxiliary battery, the memorized mode is selected automatically. Before disconnecting the auxiliary battery for repair or replacement, make sure to put the operation mode in OFF. Be careful if you are not sure which operation mode the vehicle is in when the auxiliary battery is run down.
- The operation mode cannot be changed from OFF to ACC or ON if the keyless operation key is not detected to be in the vehicle. Refer to "Keyless operation system: operating range for starting the Plug-in Hybrid EV System and changing the operation mode" on page 4-8.

ACC power auto-cutout function

E00632801034

After about 30 minutes has elapsed with the operation mode in ACC, the function auto-

matically cuts out the power for the audio system and other electric devices that can be operated with that position. When the power switch operate again, the power is supplied again.

NOTE

- It is possible to modify functions as follows:
 - The time until the power cuts out can be changed to about 60 minutes.
 - The ACC power auto-cutout function can be deactivated.
 For details, we recommend you to consult a MITSUBISHI MOTORS Authorised Service Point. On vehicles equipped with Mitsubishi Multi-Communication System (MMCS), screen operations can be used to make the adjustment. Refer to the separate owner's manual for details.

7

Operation mode OFF reminder system

E00632201041



Starting and stopping the Plug-in Hybrid EV System

When the operation mode is in any mode other than OFF, if you close all the doors and the tailgate then try to lock the doors and tailgate by pressing the driver's or front passenger's dppr lock/unlock switch, or the tailgate LOCK switch, a warning display will appear, and the outer buzzer will sounds and you cannot lock the doors and tailgate.

7 Operation mode ON reminder system

E00632301042



If the driver's door is opened with the Plug-in Hybrid EV System stopped and the operation mode in any mode other than OFF, the operation mode ON reminder inner buzzer sounds intermittently to remind you to put the operation mode in OFF.

Starting and stopping the Plug-in Hybrid EV System

E00620601295

Starting the Plug-in Hybrid EV System

E00620701443

CAUTION

- When the Plug-in Hybrid EV System warning lamp comes on while the READY indicator is on, avoid high-speed driving and have your vehicle inspected by a MITSUBISHI MOTORS Authorised Service Point as soon as possible. (Refer to "Plug-in Hybrid EV System warning lamp" on page 6-39.)
- Never attempt to start the engine by pushing or pulling the vehicle.

1. Check that the EV charging cable is not connected to your vehicle.
2. Fasten the seat belt.
3. Make sure the parking brake is applied.
4. When you press the power switch while depressing the brake pedal with your right foot, the READY indicator in the meter blinks and the activation of Plug-in Hybrid EV System starts.

5. When the READY indicator changes from blinking to staying on, the startup of Plug-in Hybrid EV System is activated and the vehicle is now ready to drive.

CAUTION

- Do not press the power switch while holding the select lever at the operated position.

NOTE

- Continue to depress the brake pedal until the READY indicator in the meter stays on.
- You can drive your vehicle even if the engine is stopped.
- Plug-in Hybrid EV System can be started in any operation mode.
- If the READY indicator does not come on, check the select position indicator. If the indicator is not indicating "P", press the electrical parking switch to display "P" position.
- If the READY indicator does not come on, turn the power switch to OFF once and, after a while, press the power switch to start Plug-in Hybrid EV System.

Stopping the Plug-in Hybrid EV System

E00620801268

1. Stop your vehicle completely.

Starting and stopping the Plug-in Hybrid EV System

2. Apply the parking brake firmly while depressing the brake pedal.
3. After pressing the electrical parking switch, press the power switch to stop Plug-in Hybrid EV System. (Refer to “Electrical Parking switch” on page 7-16.)

WARNING

- **Never stop Plug-in Hybrid EV System during running except in emergency. The effectiveness of the brake becomes very poor and the steering wheel becomes very heavy, which can easily lead to an accident.**

NOTE

- Do not operate the power switch during running except in emergency. If you have to stop Plug-in Hybrid EV System in emergency during running, continue to press the power switch for three seconds or longer or press the power switch three times or more quickly. Plug-in Hybrid EV System stops, the operation mode turns to ACC, and the selector lever position shifts to the “P” position at very slow speed.
- If you press the power switch when the selector lever position is other than “P” position while your vehicle is stopped, the selector lever position automatically shifts to “P” position, Plug-in Hybrid EV System stops, and the power mode turns to “OFF”.

NOTE

- If the parking lock mechanism is faulty, a warning is displayed on the information screen in the multi-information display. When this warning is displayed, Plug-in Hybrid EV System cannot be stopped unless you apply the parking brake and then press the power switch. Park on a flat place with the parking brake securely applied. Have your vehicle inspected by a MITSUBISHI MOTORS Authorised Service Point.



If the keyless operation key is not operating properly

E00632901022

Insert the keyless operation key into the key slot. Starting the Plug-in Hybrid EV System and changing the operation mode should be now possible.

Remove the keyless operation key from the key slot after starting the Plug-in Hybrid EV System or changing the operation mode.

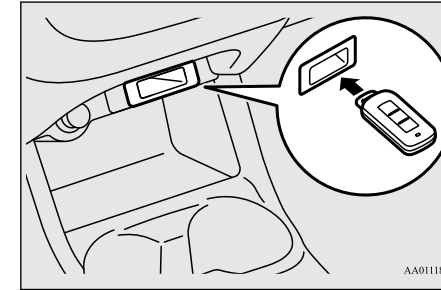

AA0111810

NOTE

- Do not insert into the key slot anything other than the keyless operation key. This could cause damage or a malfunction.
- Remove the object or additional key from the keyless operation key before inserting the key into the key slot. The vehicle may not be able to receive the registered ID code from the registered key. Therefore, the Plug-in Hybrid EV System may not start and the operation mode may not change.

7

Keyless operation key reminder

E00633001046



Selector Lever (Joystick Type)

If the operation mode is in OFF and the driver's door is opened with the keyless operation key in the key slot, the outer buzzer sounds for approximately 3 seconds and the inner buzzer sounds for approximately 1 minute or warning display will appear to remind you to remove the key.

Selector Lever (Joystick Type)

7

E00636100054

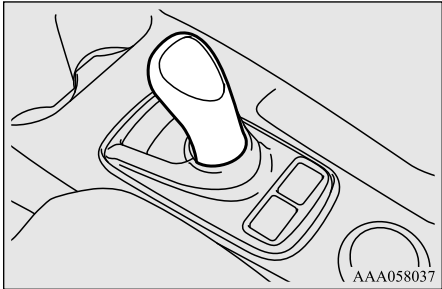

Selector lever operation

E00636200026

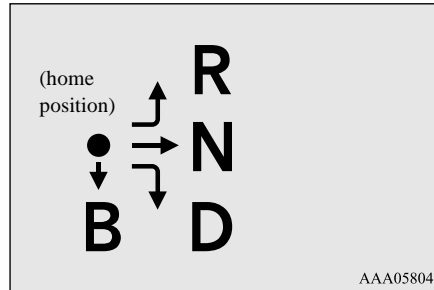

Operate the selector lever slowly and securely in the following method.

· (home position) to "D" or "R": Simply shift the lever.

· (home position) to "N": Shift and hold at "N" position for a while.

· (home position) to "B": You can shift the selector lever to "B" only when the select position is in "D" position.

When shifted from (home position) to "B", the regenerative brake force will increase by one step.

When shifted to "B" once again, the regenerative brake force will become the maximum.

When you shift the selector lever to "D", the select position returns to "D".

NOTE

- If you operate the select lever to (B) twice too quickly, the regenerative brake force may not become the maximum.

The selector lever always returns to its home position when it is released.

WARNING

- Do not replace the selector lever knob other than MITSUBISHI MOTORS genuine part. In addition, do not hang an object on the selector lever as it may be a cause of an accident.
- When you shift the selector lever to "D" or "R" position, always depress the brake pedal with your right foot for your safety. Never shift the lever while depressing the accelerator pedal. Doing so will start your vehicle abruptly, which may lead to a serious accident. It may also be a cause of failure of vehicle.

NOTE

- You cannot operate the regenerative brake while the adaptive cruise control system (ACC) is operating.
- Every time operating the selector lever, be sure to check the position displayed on the indicator.

Select Position indicator

NOTE

- If you perform the following operation, the buzzer may sound and the select position may automatically shifts to “N” position.
 - Presses the electrical parking switch during running
 - Shifts the selector lever to “R” while driving forward
 - Shifts the selector lever to “D” while driving backward
 - Shifts the selector lever to “B” in “R” position
- If you perform the following operation, the buzzer sounds and the select lever operation is cancelled.
 - When in “P” position, shifts the selector lever without depressing the brake pedal
 - When in “P” or “N” position, shifts the selector lever to (B)
 - Operates the selector lever with the EV charging cable connected
- If you shift and hold the selector lever for about 15 seconds or longer, the buzzer sounds.
The buzzer stops sounding when you release the selector lever.
- If the driver’s door is opened while the vehicle is stopped or is running at very low speed with the select position in other than “P” position and the READY indicator in the meter is illuminating, the buzzer sounds. The buzzer stops sounding if you close the door or shift the selector lever to “P”.

Select Position indicator

E00636300027

This indicator displays the selector lever position in the meter.

When “B” position is selected, selected regenerative brake force position is also displayed at “B” position.

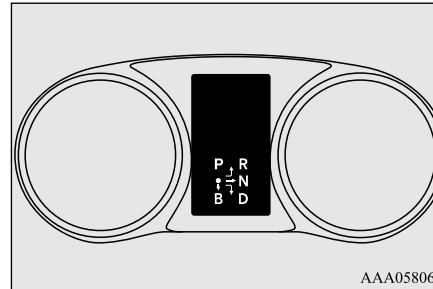

AAA058066

Selector lever positions

E00636400028

“P” PARK

The wheel are locked. When you park your vehicle, be sure to apply the parking brake and press the electrical parking switch.

“R” REVERSE

This position is to back up.

“N” NEUTRAL

No power is transmitted to the wheels. The wheels are not locked.

WARNING

- Never move the selector lever to the “N” (NEUTRAL) position while driving, you will lose Regenerative braking.
- Always keep your right foot on the brake pedal when shifting into or out of “N”, to minimize the risk of loss of control.

7

“D” DRIVE

This position is for normal driving.

“B” REGENERATIVE BRAKE

This position is for the regenerative braking. You can adjust the regenerative braking force up to two level.
Refer to “Selector lever operation” on page 7-14.

Electrical Parking switch

Refer to “When driving downhill” on page 7-26.

WARNING

- Sudden Regenerative brake may cause the tyres to skid.
Select this position according to the road conditions and vehicle speed.

7

Electrical Parking switch

E0063660020

When you park your vehicle, be sure to apply the parking brake and press the electrical parking switch to lock the wheels. The indicator on the switch illuminates in green and the select position indicator displays “P” on the information screen in the meter.

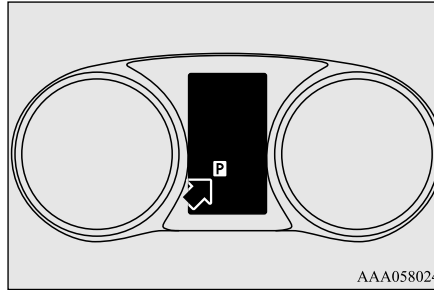
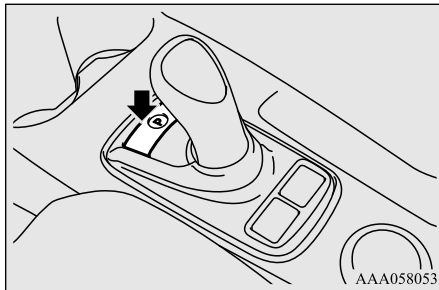

CAUTION

- If you operate the electrical parking switch and the select lever repeatedly within a short time, the shifting from the “P” position or to the “P” position is restrained for a certain period for the system protection. In such a case, wait for a while and then perform the operation.
- If the parking lock mechanism is faulty, a warning is displayed on the information screen in the multi-information display. When this warning is displayed, park on a flat place with the parking brake securely applied. Have your vehicle inspected by a MITSUBISHI MOTORS Authorized Service Point.



CAUTION

- If you press the electrical parking switch before your vehicle stops completely, the vehicle makes a sudden stop, which may cause injury to passengers. This also can be a cause of failure of the vehicle.
- Do not place an object around the electrical parking switch. The electrical parking switch may be pressed by the object when you place it there or when you somehow touch it. This will cause unintentional shifting to “P” or “N” position, which may lead to an accident.
- Be careful not to spill beverages, etc. around the electrical parking switch. The electrical parking switch may be stuck to the pressed position when it is pressed.

NOTE

- When the selector lever is shifted from the “P” position or to the “P” position, operating noise and vibration of the parking lock are felt, but this is normal.

Electrical Parking switch reminder buzzer

If the driver’s door is opened with the select position other than “P” when the vehicle is at a stop, the buzzer sounds to warn to press the electrical parking switch.

Regenerative braking level selector (paddle)*

E00636700021

Regenerative braking level selector (paddle) can quickly change the regenerative brake force keeping your hand on the steering wheel when you release your foot from the accelerator pedal while driving.

By pulling the regenerative braking level selector, the brake force (amount of electrical energy to charge the drive battery) can be adjusted according to the driving condition such as before curve or a downhill.

Regenerative braking level can be switched in the 6 level from B0 (small regenerative braking force) to B5 (large regenerative braking force).

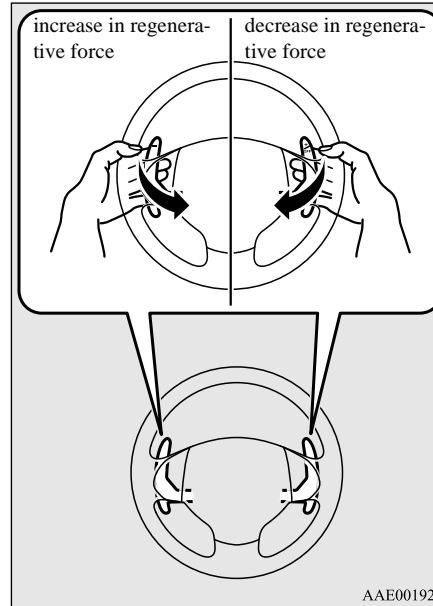

CAUTION

- If a large regenerative brake force is applied on a slippery road, tyres may skid. Always drive safely in accordance with the prevailing road condition.
- If you operate the right and left paddles simultaneously, a regenerative brake force level may not change.

Regenerative braking level selector (paddle)*

NOTE

- Repeated continuous operation of a paddle will continuously change the brake force levels.
- If you turn on the cruise control when the level B0 or B1 (smaller regenerative brake force) is selected, the level is returned to the normal level B2 automatically.
- under the cruise control, the level B0 or B1 cannot be selected. The buzzer sounds if you try to select these levels.
- On vehicles with the adaptive cruise control system (ACC), you cannot control the regenerative brake force level while the adaptive cruise control system (ACC) is operating. The buzzer sounds if you operate the paddles.

7

To decrease generative force

Each time you pull the + (UP) paddle toward you, the regenerative brake force lowers by one level.

S-AWC (Super All Wheel Control)

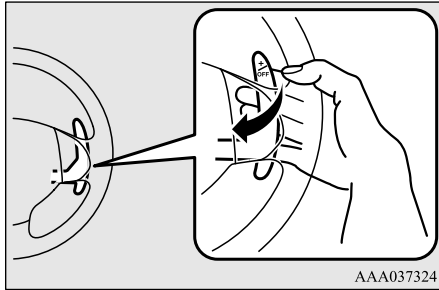

To return to the normal regenerative brake force level of B2

Pull the + (UP) paddle for approx. 2 seconds or longer. The select lever position indicator displays “D”.

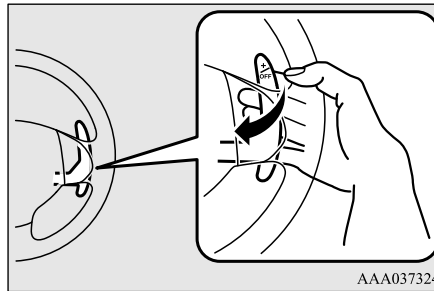

7

To increase generative force

Each time you pull the - (DOWN) paddle toward you, the regenerative brake force rises by one level.

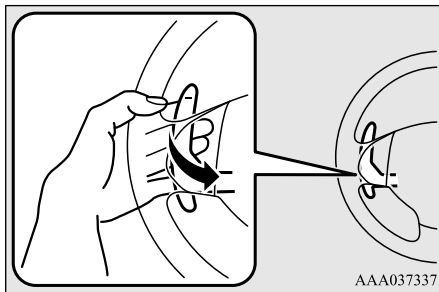

S-AWC (Super All Wheel Control)

E00622601097

S-AWC is an integrated vehicle dynamics control system that helps enhance driving performance, cornering performance, and vehicle stability over a wide range of driving conditions through integrated management of the twin motor 4WD, the AYC (Active Yaw Control), the ABS and the ASC.

CAUTION

- Do not over-rely on the S-AWC. Even the S-AWC cannot prevent the natural laws of physics from acting on the vehicle. This system, like any other system, has limits and cannot help you to maintain traction and control of the vehicle in all circumstances. Reckless driving can lead to accidents. It is the driver's responsibility to drive carefully. This means taking into account the traffic, road and environmental conditions.

Twin Motor 4WD

This system improves vehicle stability performance and fuel economy performance during acceleration and deceleration by motors provided at front and rear wheels, respectively, controlling the distribution of a drive force between the front and rear wheels optimal for the operation of the driver.

Active yaw control system (AYC)

E00622801044

The AYC is a system, with a left-right differential limiting function and yaw control function, that controls the left-right driving/braking force by managing the brake.

S-AWC (Super All Wheel Control)

⚠ CAUTION

- Control of the braking force does not enhance the stopping performance of the vehicle, therefore, pay careful attention to the safety of your surroundings when driving.

Left-right differential limiting function

The left-right differential limiting function is a function that enhances driving performance and vehicle stability by preventing idle spinning of a wheel when driving on slippery road or when the road surfaces of left and right wheels are different.

Yaw control function

The yaw control function is a function that enhances vehicle cornering performance and vehicle stability with management of vehicle turning power (yaw moment) by controlling the braking force when the vehicle does not turn in response to steering input, such as when the steering wheel is turned quickly or when driving on slippery road.

4WD lock switch

E00637000021

If the 4WD lock switch is pressed when the power mode is “ON”, it will switch to “4WD LOCK.”

It can use from a low-speed to high-speed operation, and the driving stability improves on a wet road surface or a snowy road, etc.

If the 4WD lock switch is pressed once again, it will return to “NORMAL.”.

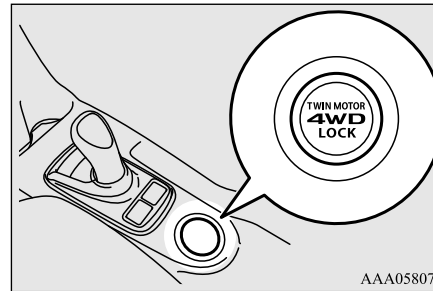

AAA058079

When the 4WD LOCK mode is activated, the above display appears on the information screen in the multi-information display for some seconds.



⚠ CAUTION

- Use tyres of the same specified size, same type, same brand and no wear difference. If tyres of different size, type, brand and degree of wear are used, a warning of EV system abnormality may be displayed.

7

S-AWC operation display

E00623101190

The S-AWC operation status can be displayed on the information screen in the multi-information display.

To display the status, press the multi-information display switch to change the information screen.

Refer to “Information screen (when the operation mode in ON)” on page 6-7.

4-wheel drive operation

Display example

The S-AWC operation status is displayed.

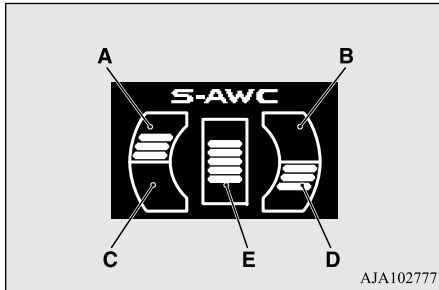

Yaw control function display

The amount of the yaw moment is displayed as a bar graph.

A,D- Clockwise yaw moment about the vehicle's center of gravity

B,C- Counterclockwise yaw moment about the vehicle's center of gravity

Torque distribution function display

The torque distribution between the front and rear wheels is displayed in section E of the meter as a bar graph.

WARNING

- Always concentrate on your driving first. Keep your eyes and mind on the road. Distractions while driving can lead to an accident.

When the ECO mode switch is ON

E00636501039

While the drive mode is in the "4WD LOCK" position, if the ECO mode switch is switched ON, the drive mode will be changed to "ECO LOCK" mode.



If the ECO mode switch is switched OFF, the drive mode will be returned to "4WD LOCK" mode.

Refer to the "ECO mode switch" on page 6-46.

4-wheel drive operation

E00606602083

Your vehicle has been designed primarily for use on pavement.

But its unique 4-wheel drive system allows you to occasionally travel on unpaved roads, to campgrounds, picnic sites, and similar locations.

Not only does this ensure better handling on dry, paved roads but also permits better traction when driving on slippery, wet or snow-covered roads and when moving out of mud.

But it is not suitable for heavy off road use or towing in rough conditions.

It is particularly important to note that 4-wheel drive may not give sufficient hill climbing ability and regenerative brake on steep slopes. You should try to avoid driving on steep slopes.

Also, you must exercise caution when driving on sand and mud and when driving through water because sufficient traction may not be available in certain circumstances.

Please avoid driving the vehicle through areas where the tyres may get stuck in deep sand or mud.

Inspection and maintenance following rough road operation

WARNING

- Do not over-rely on the 4-wheel drive vehicles. Even 4-wheel drive vehicles have limits to the system and ability to maintain control and traction. Reckless driving may lead to accidents. Always drive carefully, taking account of the road conditions.
- Improperly operating this vehicle on or off-pavement can cause an accident or rollover in which you and your passengers could be seriously injured or killed.
 - Follow all instructions and guidelines in the owner's manual.
 - Keep your speed low and do not drive faster than conditions.

NOTE

- Driving on rough roads can be hard on a vehicle. Before you leave the pavement, be sure all scheduled maintenance and service has been done, and that you have inspected your vehicle. Pay special attention to the condition of the tyres, and check the tyre pressures.
- MITSUBISHI MOTORS is not responsible to the operator for any damage or injury caused or liability incurred by improper and negligent operation of a vehicle. All techniques of vehicle operation depend on the skill and experience of the operator and other participating parties. Any deviation from the recommended operating instructions above is at their own risk.

NOTE

- Note that the stopping distance required of the 4-wheel drive vehicle differs very little from that of the 2-wheel drive vehicle. When driving on a snow-covered road or a slippery, muddy surface, make sure that you keep a sufficient distance between your vehicle and the one ahead of you.
- The driving posture should be more upright; adjust the seat to a good position for easy steering and pedal operation. Be sure to wear the seat belt.
- After driving on rough roads, check each part of the vehicle and wash it thoroughly with water. Refer to the "Inspection and maintenance following rough road operation" section and "Maintenance" sections.

Climbing/descending sharp grades

Your vehicle may not provide sufficient hill climbing ability and regenerative brake on steep slope. Avoid driving on steep slopes even though the vehicle is an 4-wheel drive vehicle.

Inspection and maintenance following rough road operation

E00606701407

After operating the vehicle in rough road conditions, be sure to perform the following inspection and maintenance procedures:

- Check that the vehicle has not been damaged by rocks, gravel, etc.
- Carefully wash the vehicle with water. Drive the vehicle slowly while lightly depressing the brake pedal in order to dry out the brakes. If the brakes still do not function properly, we recommend you to have the brakes checked as soon as possible.
- Remove the insects, dried grass, etc. clogging the radiator core.
- Check the inside of the vehicle. If water entry is found, dry the carpet etc.
- Inspect the headlamps, If the headlamp bulb is flooded with water, we recommend you to have it drained.

7

Cautions on the handling of 4-wheel drive vehicles

Cautions on the handling of 4-wheel drive vehicles

E00606801860

Tyres and wheels

Since the driving torque can be applied to the 4 wheels, the driving performance of the vehicle when operating in 4-wheel drive is greatly affected by the condition of the tyres.

7

Pay close attention to the tyres.

- Install only the specified tyres on all wheels. Refer to “Tyres and wheels” on page 12-8.
- Be sure all 4 tyres and wheels are the same size and type.
When it is necessary to replace any of the tyres or wheels, replace all four.
- All tyres should be rotated before the wear difference between the front and rear tyres is recognisable.

Good vehicle performance cannot be expected if there is a difference in wear between tyres. Refer to “Tyre rotation” on page 11-11.

- Check the tyre inflation pressure regularly.

7-22 Starting and driving

CAUTION

- Always use tyres of the same size, type, and same brand that have no wear differences. Using tyres of different size, type, brands or degree of wear, will increase the differential oil temperature and result in possible damage to the driving system. Further, the drive train will be subject to excessive loading, possibly leading to oil leakage, component seizure, or other serious failures.

Towing

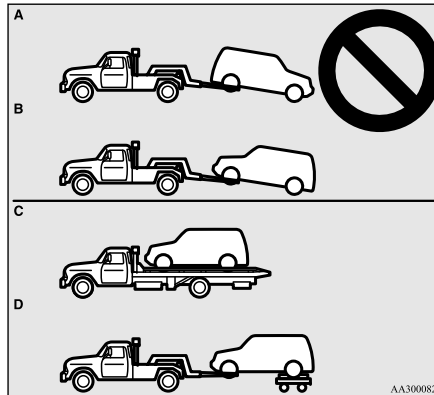

CAUTION

- Do not tow 4-wheel drive vehicles with the front or rear wheels on the ground (Type A or Type B) as illustrated. This could result in damage to the drivetrain, or unstable towing. If you tow 4-wheel drive vehicles, use Type C or Type D equipment.

Jacking up a 4-wheel drive vehicle

WARNING

- Do not turn on Plug-in Hybrid EV System or turn a jacked-up wheel when the vehicle is jacked up. The tyre in contact with the ground may turn and the vehicle may come off the jack, possibly leading to an accident. Besides, do not touch the high-voltage area.

Battery save switch

E00636800022

It can be keep the remaining quantity of the drive battery if you drive in the EV driving mode at a residential area or use electric power at the destination.

Moreover, the electric power consumption of the drive battery can also be held down by

pressing the battery save switch while high-speed driving.

If the battery save switch is pressed while the READY indicator is on, the engine will start to keep the remaining quantity of the drive battery, the vehicle operates in the series hybrid mode or the parallel hybrid mode. It can be canceled, if it pressed once again.

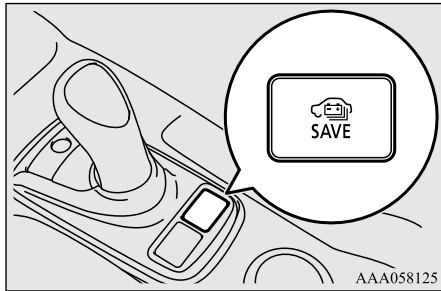

If the battery save mode is activated, the following image is displayed on the information screen in the multi-information display.



NOTE

- The engine may stop when the vehicle stops or is running.

NOTE

- Even if the battery save switch is pressed, the battery save mode may not be activated depending on the remaining drive battery capacity or the remaining fuel quantity.

When the Battery charge switch is ON

When the battery charge switch is turned on while running in the battery save mode, the mode changes to the battery charge mode.



If the battery save switch is pressed, the mode is returned to the battery save mode.

Battery charge switch

E00636900023

It can be used when increasing the remaining quantity of the drive battery.

Use the battery charge switch before driving at long up hills, such as mountains with a steep slope.

By charging the drive battery before driving, it becomes possible to continue hill-climbing performance (driving force).

Battery charge switch

If the battery charge switch is pressed while the READY indicator is on, the engine will start and it can charge the drive battery to near the full charge during the vehicle is run and stopped.

It can be canceled, if it press once again.

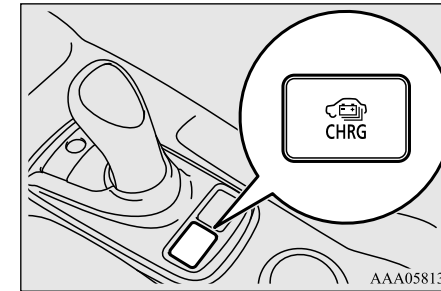

7

If the battery charge mode is activated, the following image is displayed on the information screen in the multi-information display.



WARNING

- When you leave the vehicle, be sure to stopped the Plug-in Hybrid EV System. Refer to "Parking" P.7-5

Acoustic Vehicle Alerting System (AVAS)

WARNING

- Since the engine will start also in the vehicle stops if the battery charge switch is pressed, do not use it for the around of the garage or the vehicle in the situation such as snow lay etc. while stopping and parking.
Doing so, the exhaust gas enters into the vehicle and there is a possibility of becoming carbon monoxide poisoning.
Be sure to use at the well-ventilated place.
- Do not use the battery charge switch near flammable which a dried grass or a paper etc..
There is a possibility of becoming a fire because the exhaust pipe is high temperature.

7

CAUTION

- I left something so as to close the front of the vehicle, do not operate the battery charger switch.

NOTE

- Use the battery charge switch before the uphill climb.
- Even if the battery charge switch is pressed, the battery charge mode may not be activated depending on the remaining drive battery capacity or the remaining fuel quantity and the control.

NOTE

- It is recommended to use the battery charging switch before at least 20 minutes, if you climb to continue the speed of more than 100km/h or the long slope (gradient of more than 4 %) is expected. (According to a towing weight, it may not be able to continue the speed.)
- When using the battery charge switch a long time with vehicle stopping under high temperature, it may not be charged.
- The charging time close to full charge of the drive battery becomes longer depending on the condition of the drive battery, a driving condition or a environment.
- The engine may stop near full charge.
- If you press the battery charge switch, in order to generate electricity using gasoline, the fuel consumption will suffer.
We recommend you use considered environment.
- When the engine is started while parking, there is a risk of penalties related to idling stop ordinance.
You should use the battery charge switch with confirming to the relevant municipality.
Also, if the engine is started, in order to consume gasoline, be careful not to cause no fuel.

When the Battery save switch is ON

When the battery save switch is turned on while driving in the battery charge mode, the mode changes to the battery save mode.



If the battery charge switch is pressed, the mode is returned to the battery charge mode.

Acoustic Vehicle Alerting System (AVAS)

E00631601051

The Acoustic Vehicle Alerting System (AVAS) is device that uses sound to alert pedestrians of the presence of the vehicle. The system operates when the vehicle speed is about 35 km/h or less and the engine is not running.

The sound starts when the AVAS is operated with the following conditions.

- When the vehicle speed is about 3 km/h or less with engine not running and the brake pedal is not depressed.

- When the vehicle speed is about 3 km/h to 35 km/h and engine is not running.

The sound does not start in the following cases.

- When the vehicle speed is about 3 km/h or less and the brake pedal is depressed.
- When the vehicle speed is about 35 km/h or more.
- When the select position is “P” (PARK) position.
- When the AVAS OFF indicator in the meter is illuminating.
- When the engine is running.

When the operation mode is set to “ON”, the AVAS OFF indicator comes on and goes out in a few seconds.

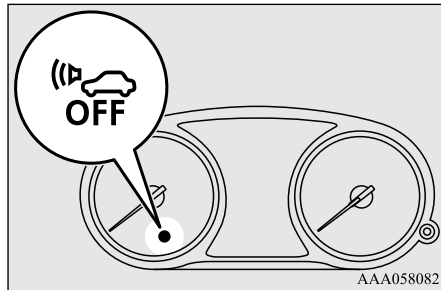

WARNING

- Even if the Acoustic Vehicle Alerting System (AVAS) sounds, pay special attention to pedestrians.
Pedestrians may not notice the oncoming vehicle, which may cause an accident resulting in serious personal injury or death.

CAUTION

- Always confirm the indicator lamp goes off before driving.
If the indicator lamp blinks, the operation mode is put in OFF, and the operation mode is put in OFF once again. It is not abnormally if the indicator lamp goes off. If the indicator lamp blinks again, have the vehicle inspected at a MITSUBISHI MOTORS Authorised Service Point as soon as possible.

AVAS OFF switch

E00631701052

If the operation mode is put in ON, the AVAS is automatically turned on.

The AVAS should be turned on while normal driving.

When driving on the freeway etc., it is possible to turn off by pressing the AVAS OFF switch.

Acoustic Vehicle Alerting System (AVAS)

If pressing the AVAS OFF switch, the audible alarm not sound and indicator lamp illuminates.

If pressing the AVAS OFF switch once again, the AVAS is activated and the indicator lamp goes off.

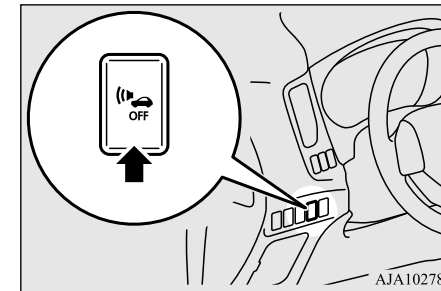

7

WARNING

- Never turn the Acoustic Vehicle Alerting System (AVAS) off if there is a possibility where the pedestrian exists.

NOTE

- If the operation mode is put in OFF, while the AVAS has been turned off, and the operation mode is put in ON once again, the AVAS is activated.

Braking

NOTE

- If the AVAS OFF switch is continuously pressed after the AVAS is turned off, the incorrect operation prevention function works and then the system returns to turning on.

Braking

E00607002983

7

All the parts of the brake system are critical to safety. We recommend you to have the vehicle checked at regular intervals according to the service booklet.

CAUTION

- Avoid driving habits that cause heavy braking and never “ride” the brakes by resting your foot on the brake pedal while driving. It causes brake overheating and fade.

Brake system

The service brake is divided into two brake circuits. And your vehicle is equipped with power brakes. If one brake circuit fails, the other is available to stop the vehicle. If your vehicle should lose the power assist for some reason, the brakes will still work. In these situations, even if the brake pedal moves down to the very end of its possible stroke or resists

7-26 Starting and driving

being depressed, keep depressing the brake pedal down harder and further than usual; stop driving as soon as possible and have the brake system repaired.

WARNING

- Do not turn off the Plug-in Hybrid EV System while your vehicle is in motion. If you turn off the Plug-in Hybrid EV System while driving, the power assistance for the braking system will stop working and your brakes will not work effectively.
- If the power assist is lost or if either brake hydraulic system stops working properly, have your vehicle checked immediately.

Warning display

The brake warning lamp illuminates to indicate a fault in the braking system. A warning is also displayed on the multi information display. Refer to “Brake warning lamp” and “Brake warning display” on page 6-37, 6-39.

When brakes are wet

Check the brake system while driving at a low speed immediately after starting, especially when the brakes are wet, to confirm they work normally.

A film of water can be formed on the brake discs and prevent normal braking after driving in heavy rain or through large puddles, or after the vehicle is washed. If this occurs, dry the brakes out by driving slowly while lightly depressing the brake pedal.

When driving downhill

WARNING

- Do not leave any objects near the brake pedal or let a floor mat slide under it; doing so could prevent the full pedal stroke that would be necessary in an emergency. Make sure that the pedal can be operated freely at all times. Make sure the floor mat is securely held in place.

CAUTION

- Put the selector lever to “B” position according to the grade of a slope or the speed in a long downward slope, and use the regenerative brake together. If you depress the brake pedal and slowing down is repeated frequently, the foot brake may be overheated and effectiveness may worsen.

Hill start assist

CAUTION

- Effectiveness of the regenerative brake becomes weak with close to full charge of the drive battery and loses its effect at the full charge.
In this case, since the foot brake is effective, use the foot brake and slow down your vehicle speed beforehand.
The energy usage indicator stops swaying in the charge zone closer to full charge. Refer to “Energy usage indicator” on page 6-2.
In such case, drive at low speed in advance. And if needed use the foot brake to slow down vehicle speed before the vehicle speed increases.
The regenerative brake comes to be effective if the drive battery remaining power is consumed.

Brake pad

- Avoid hard braking situations. New brakes need to be broken-in by moderate use for the first 200 km.

- The disc brakes are provided with a warning device which emits a shrieking metallic sound while braking if the brake pads have reached their limit. If you hear this sound, have the brake pads replaced immediately.

WARNING

- **Driving with worn brake pads will make it harder to stop, and can cause an accident.**

Hill start assist

E00628001237

The hill start assist makes it easy to start off on a steep uphill slope by preventing the vehicle from moving backwards. It keeps the braking force for about 2 seconds when you move your foot from the brake pedal to the accelerator pedal.

CAUTION

- Do not overly rely on the hill start assist to prevent backwards movement of the vehicle. Under certain circumstances, even when hill start assist is activated, the vehicle may move backwards if the brake pedal is not sufficiently depressed, if the vehicle is heavily loaded, or if the road is very steep or slippery.

CAUTION

- The hill start assist is not designed to keep the vehicle stopped in place on uphill slopes for more than 2 seconds.
- When facing uphill, do not rely on using the hill start assist to maintain a stopped position as an alternative to depressing the brake pedal. Doing so could cause an accident.
- Do not turn the operation mode in ACC or OFF while the hill start assist is operating. The hill start assist could stop operating, which could result in an accident.

7**To operate**

E00628101368

1. Stop the vehicle completely using the brake pedal.
2. Move the selector lever to the “D” position.

NOTE

- When reversing on an uphill slope, move the selector lever to the “R” position.

3. Release the brake pedal and the hill start assist will maintain the braking force applied while stopping for approximately 2 seconds.
4. Depress the accelerator pedal and the hill start assist gradually will decrease the braking force as the vehicle starts moving.

Starting and driving 7-27

Brake assist system

NOTE

- The hill start assist is activated when all of the following conditions are met.
 - The Plug-in Hybrid EV System is operating.
(The hill start assist will not be activated while the Plug-in Hybrid EV System is starting or immediately after the Plug-in Hybrid EV System is started.)
 - The select position is in any position other than “P” or “N”.
 - The vehicle is completely stationary, with the brake pedal depressed.
 - The parking brake is released.
- The hill start assist will not operate if the accelerator pedal is depressed before the brake pedal is released.
- The hill start assist also operates when reversing on an uphill slope.

7

Warning display

E00628201369

If an abnormal condition occurs in the system, the following Warning lamp/Warning display will turn on.

Warning lamp



Warning display



CAUTION

- If the warning is displayed, the hill start assist will not operate. Start off carefully.
- Park your vehicle in a safe place and stop the Plug-in Hybrid EV System.
Restart the Plug-in Hybrid EV System and check whether the display/indicator goes out, in which case the hill start assist is again working normally.
If they remain displayed or reappear frequently, it is not necessary to stop the vehicle immediately, but the vehicle should be inspected by a MITSUBISHI MOTORS Authorised Service Point as soon as possible.

Brake assist system

E00627001546

The brake assist system is a device assisting drivers who cannot depress the brake pedal firmly such as in emergency stop situations and provides greater braking force.

If the brake pedal is depressed suddenly, the brakes will be applied with more force than usual.

CAUTION

- The brake assist system is not a device designed to exercise braking force greater than its capacity. Make sure to always keep a sufficient distance between vehicles in front of you without relying too much on the brake assist system.

NOTE

- Once the brake assist system is operational, it maintains great braking force even if the brake pedal is lightly released.
To stop its operation, completely remove your foot from the brake pedal.
- When the brake assist system is in use while driving, you may feel as if the depressed brake pedal is soft, the pedal moves in small motions in conjunction with the operation noise, or the vehicle body and the steering wheel vibrate. This occurs when the brake assist system is operating normally and does not indicate faulty operation. Continue to depress the brake pedal.
- You may hear an operation noise when the brake pedal is depressed suddenly while stationary. This does not indicate a malfunction and the brake assist system is operating normally.
- When the anti-lock brake system warning lamp or only active stability control warning lamp illuminate, the brake assist system is not functioning.

Emergency stop signal system*

E00626001073

This is a device that reduces the possibility of rear end collisions by the rapid and automatic blinking of the hazard warning lamps to alert vehicles approaching from behind during sudden braking. When the emergency stop signal system operates, the hazard warning indicator lamp in the instrument cluster blinks rapidly at the same time.

CAUTION

- If the ABS warning or ASC warning is displayed, the emergency stop signal system may not operate. Refer to “ABS warning lamp/display” on page 7-30. Refer to “ASC warning display” on page 7-34.

NOTE

- [Activating condition for the emergency stop signal system]
It activates when all of the following conditions are met.
 - The vehicle speed is approximately 55 km/h or higher.

NOTE

- The brake pedal has been depressed, and the system judges that it was sudden braking from the vehicle deceleration and the operating condition of the anti-lock brake system (ABS).

[Deactivating condition for the emergency stop signal system]

It deactivates when one of the following conditions is met.

- The brake pedal is released.
- The hazard warning flasher switch is pressed.
- The system judges that it was not sudden braking from the vehicle deceleration and the operating condition of the anti-lock brake system (ABS).

Anti-lock brake system (ABS)

E00607102489

Environmental conditions can have an effect on braking. During sudden braking when there is snow, ice, oil, water etc. on the road surface, a skid may occur. In this situation, steering control and braking effectiveness is reduced and the stopping distance is increased. The vehicle may also go into an uncontrolled spin.

The ABS helps prevent the wheels from locking during braking, thus maintaining direc-

Emergency stop signal system*

tional stability, ensuring controllability and providing optimum braking force.

Operating hints

- Always maintain the same distance from the vehicle in front of you as you would for a vehicle not equipped with ABS. Compared with vehicles not fitted with ABS, your vehicle may require a longer stopping distance in the following cases:
 - Driving on gravel or snow-covered roads.
 - Driving with snow traction device (tyre chains) installed.
 - Driving on roads where the road surface is pitted or has other differences in surface height.
 - Driving on bumpy roads or other poor driving surfaces.
- Operation of ABS is not restricted to situations where brakes are applied suddenly. This system may also operate to prevent wheel lock when you are driving over manholes, steel road-work plates, or the vehicle is driven over steps or level differences in the road, road markings, or other surfaces which are difficult for the wheels to grip.

7

Anti-lock brake system (ABS)

7

- When the ABS is activated, you may feel the brake pedal pulsation and the vibrations of the vehicle body and steering wheel. You may also hear a characteristic noise. At this time, you may feel as if the pedal attempts to resist being depressed. This is a normal result of the ABS operation, and does not indicate a problem.
If this situation occurs, depress the brake pedal more firmly in order to operate the ABS. Do not pump the brake. This will result in reduced braking performance.
- You will hear the operation sound of the motor coming from the Plug-in Hybrid EV System compartment immediately following start off after starting the Plug-in Hybrid EV System. If the brake pedal is depressed at that moment, a brake pedal pulsating is felt.
This pulsation is due to the self-diagnosis operation of the ABS and does not indicate a malfunction.
- The ABS becomes operative after the vehicle has accelerated to a speed in excess of about 10 km/h. It stops operating when the vehicle decelerates to a speed below about 5 km/h.

CAUTION

- Even the ABS cannot prevent the natural laws of physics from acting on the vehicle. It cannot for instance avoid accidents that may result from excessive speed on bends or following another vehicle too closely or aquaplaning. It should remain the driver's task to observe safety precautions to judge speeds and brake applications correctly in such conditions.
- Be sure to use tyres of the same type and size on 4 wheels.
If tyre types or sizes are mixed, ABS may not function normally.
- Never install a limited slip differential, which is not MITSUBISHI MOTORS GENUINE parts, as the ABS may not function normally.
We recommend you to consult a MITSUBISHI MOTORS Authorised Service Point.

ABS warning lamp / display

E00607202321

Warning lamp



Warning display



If there is a malfunction in the system, the ABS warning lamp will come on and the warning display will appear on the information screen in the multi information display. Under normal conditions, the ABS warning lamp only comes on when the operation mode is put in ON and goes off a few seconds later.

CAUTION

- Any of the following warning lamp/display behaviour indicates that the ABS is not functioning and only the standard brake system is working. (The standard brake system is functioning normally.) If this happens, take your vehicle to a MITSUBISHI MOTORS Authorised Service Point.
 - When the operation mode is put in ON, the warning lamp does not come on or it remains on and does not go off
 - The warning lamp comes on while driving
 - The warning display appears while driving

If the warning lamp / display illuminate while driving

E00607302423

If only the ABS warning lamp/display illuminate

- Avoid hard braking and high-speed driving. Stop the vehicle in a safe place. Restart the Plug-in Hybrid EV System and check to see whether the lamp goes out after a few minutes driving; if it then remains off during driving, there is no problem. However, if the lamp does not go out, or if it lights up again when the vehicle is driven, we recommend you to have the vehicle checked as soon as possible.
- If you start Plug-in Hybrid EV System when the auxiliary battery voltage is insufficient, ABS warning lamp/display may illuminate, but this is not a failure of ABS. When the drive battery is charged, the auxiliary battery is also charged, and the warning lamp/display will go out. If the warning lamp/display continues illuminating even after the battery is sufficiently charged or the warning lamp/display illuminates frequently, have your vehicle inspected by a MITSUBISHI MOTORS Authorised Service Point.

If the ABS warning lamp / display and brake warning lamp / display illuminate at the same time

Warning lamp

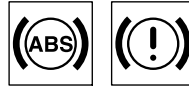

Warning display

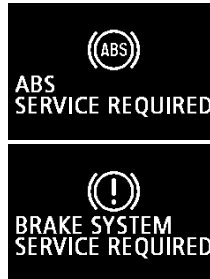

The ABS and brake force distribution function may not work, so hard braking could make the vehicle unstable. Avoid hard braking and high-speed driving. Stop the vehicle in a safe place immediately and contact a MITSUBISHI MOTORS Authorised Service Point.

Anti-lock brake system (ABS)

NOTE

- The ABS warning lamp and brake warning lamp illuminate at the same time and the warning displays appear alternately on the information screen in the multi information display.

After driving on icy roads

E00618800219

After driving on snowy roads, remove any snow and ice which may have become adhered to the wheel areas.

7

When doing this, be careful not to damage the wheel speed sensors (A) and cables located at each wheel on vehicles equipped with an ABS.

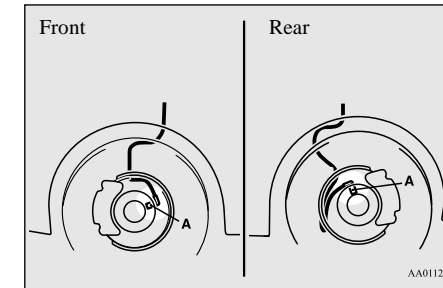

Electric power steering system (EPS)

Electric power steering system (EPS)

E00629201294

The power steering system operates while the Plug-in Hybrid EV System is operating. It helps reduce the effort needed to turn the steering wheel.

The power steering system has mechanical steering capability in case the power assist is lost. If the power assist is lost for some reason, you will still be able to steer your vehicle, but you will notice it takes much more effort to steer. If this happens, have your vehicle inspected at a MITSUBISHI MOTORS Authorised Service Point.

7

WARNING

- Do not stop the Plug-in Hybrid EV System while the vehicle is moving. Stopping the Plug-in Hybrid EV System would make the steering wheel extremely hard to turn, possibly resulting in an accident.

NOTE

- During repeated full-lock turning of the steering wheel (for example, while you are manoeuvring the vehicle into a parking space), a protection function may be activated to prevent overheating of the power steering system. This function will make the steering wheel gradually harder to turn. In this event, limit your turning of the steering wheel for a while. When the system has cooled down, the steering effort will return to normal.
- If you turn the steering wheel while the vehicle is stationary with the headlamps on, the headlamps may become dim. This behaviour is not abnormal. The headlamps will return to their original brightness after a short while.

Electric power steering system warning display



If there is a malfunction in the system, the warning display will appear on the information screen in the multi information display.

CAUTION

- If the warning display appears while the Plug-in Hybrid EV System is operating, have the vehicle inspected by a MITSUBISHI MOTORS Authorised Service Point as soon as possible. It may become harder to turn the steering wheel.

Active stability control (ASC)

E00616701497

The active stability control (ASC) takes overall control of the anti-lock brake system, traction control function and stability control function to help maintain the vehicle's control and traction. Please read this section in conjunction with the page on the anti-lock brake system, traction control function and stability control function.

Anti-lock brake system (ABS) → P.7-29
Traction control function → P.7-33
Stability control function → P.7-33

CAUTION

- Do not over-rely on the ASC. Even the ASC cannot prevent the natural laws of physics from acting on the vehicle. This system, like any other system, has limits and cannot help you to maintain traction and control of the vehicle in all circumstances. Reckless driving can lead to accidents. It is the driver's responsibility to drive carefully. This means into account the traffic, road and environmental conditions.
- Be sure to use the same specified type and size of tyre on all 4 wheels. Otherwise, the ASC may not work properly.
- Do not install any aftermarket limited slip differential (LSD) on your vehicle. The ASC may stop functioning properly.

NOTE

- An operation noise may be emitted from the Plug-in Hybrid EV System compartment in the following situations. The sound is associated with checking the operations of the ASC. At this time, you may feel a shock from the brake pedal if you depress it. These do not indicate a malfunction.
 - When the operation mode is put in ON.
 - When the vehicle is driven for a while after the Plug-in Hybrid EV System is turned on.

NOTE

- When the ASC is activated, you may feel a vibration in the vehicle body or hear a whining sound from the Plug-in Hybrid EV System compartment. This indicates that the system is operating normally. It does not indicate a malfunction.
- When the anti-lock brake system warning lamp is illuminated, the ASC is not active.

Traction control function

E0061900087

On slippery surfaces, the traction control function prevents the drive wheels from spinning excessive, thus helping the vehicle to start moving from a stopped condition. It also provides sufficient driving force and steering performance as the vehicle turns while pressing the acceleration pedal.

CAUTION

- When driving a vehicle on a snowy or icy road, be sure to install snow tyres and drive the vehicle at moderate speeds.

Stability control function

E00619101098

The stability control function is designed to help the driver maintain control of the vehicle on slippery roads or during rapid steering

Active stability control (ASC)

maneuvers. It works by controlling the Plug-in Hybrid EV System output and the brake on each wheel.

NOTE



- The stability control function operates at speeds of about 15 km/h or higher.

“ASC OFF” switch

E00619201578

7

The ASC is automatically activated when the operation mode is put in ON. You can deactivate the system by pressing down the “ASC OFF” switch for 3 seconds or longer.

When the ASC is deactivated, the  indicator will turn on. To reactivate the ASC, momentarily press the “ASC OFF” switch; the  indicator is turned off.

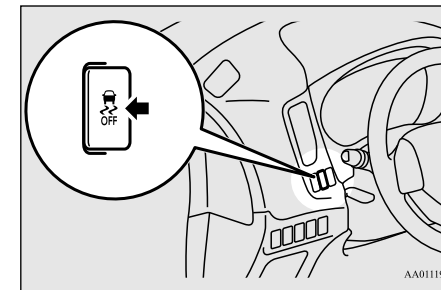

Active stability control (ASC)

CAUTION

- For safety reasons, the “ASC OFF” switch should be operated when your vehicle is stopped.
- Be sure to keep the ASC on while driving in normal circumstances.

NOTE

- When moving out of mud, sand or fresh snow, pressing the accelerator pedal may not allow the Plug-in Hybrid EV System output to increase. In such situations, temporarily turning off the ASC with the “ASC OFF” switch.
Refer to “If your vehicle becomes stuck in sand, mud or snow” page 9-22.
- Using the “ASC OFF” switch turns off both the stability control function and the traction control function.
- If you continue to press the “ASC OFF” switch after the ASC is turned off, the “mistaken operation protection function” will activate and the ASC will turn back on.

ASC operation indicator or ASC OFF indicator



E00619301638

-  - ASC operation indicator
The indicator will blink when the ASC is operating.



- ASC OFF indicator
This indicator will turn on when the ASC is turned off with the “ASC OFF” switch.

CAUTION

- When  indicator blinks, ASC is operating, which means that the road is slippery or that your vehicle’s wheels are beginning to slip. If this happens, drive slower with less accelerator input.
- If the temperature in the braking system continues to increase due to continuous brake control on a slippery road surface, the  indicator will blink. To prevent the brake system from overheating, the brake control of the traction control function will be temporarily suspended.
The Plug-in Hybrid EV System control of the traction control function and normal brake operation will not be affected. Park your vehicle in a safe place. When the temperature in the braking system has come down, the  indicator will be turned off and the traction control function will start operating again.

NOTE



- The  indicator may turn on when you start the Plug-in Hybrid EV System. This means that the battery voltage momentarily dropped when the Plug-in Hybrid EV System was started. It does not indicate a malfunction, provided that the indicator goes out immediately.

ASC warning lamp/display

E00619401655

If an abnormal condition occurs in the system, the following warning lamp/warning display will turn on.

Warning lamp

-  - ASC operation indicator
-  - ASC OFF indicator

Warning display



Cruise control*

CAUTION

- The system may be malfunctioning. Park your vehicle in a safe place and stop the Plug-in Hybrid EV System. Restart the Plug-in Hybrid EV System and check whether the display/indicator goes out. If they go out, there is no abnormal condition. If they do not go out or appear frequently, it is not necessary to stop the vehicle immediately, but we recommend you to have your vehicle inspected.

NOTE

- Your speed may decrease on a steep uphill. You may use the accelerator pedal if you want to stay at your set speed.
- Your speed may increase to more than the set speed on a steep downhill. You have to use the brake to control your speed. As a result, the set speed driving is deactivated.
- The regenerative level B0 or B1 cannot be selected under the cruise control. The buzzer sounds if you try to select these levels.

D-CANCEL switch

Used to deactivate the set speed driving.

NOTE

- When operating the cruise control switches, press the cruise control switches correctly. The set speed driving may be deactivated automatically if two or more switches of the cruise control are pressed at the same time.

Cruise control*

E00609102177

Cruise control is an automatic speed control system that keeps a set speed. It can be activated at about 40 km/h or more.

CAUTION

- When you do not wish to drive at a set speed, turn off the cruise control for safety.
- Do not use cruise control when driving conditions will not allow you to stay at the same speed, such as in heavy traffic or on roads that are winding, icy, snow-covered, wet, slippery, on a steep downhill slope.

NOTE

- Cruise control may not be able to keep your speed on uphill or downhills.

Cruise control switches

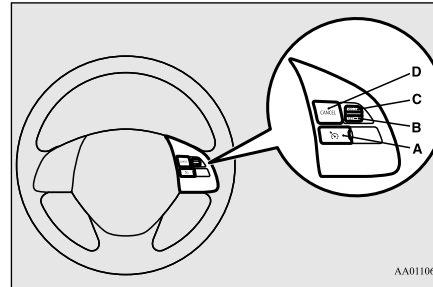

AA0110608

A-CRUISE CONTROL ON/OFF switch

Used to turn on and off the cruise control.

B-SET - switch

Used to reduce the set speed and to set the desired speed.

C-RES + switch

Used to increase the set speed and to return to the original set speed.

To activate

E00609302238

7

1. With the operation mode in ON, press the CRUISE CONTROL ON/OFF switch (A) to turn on the cruise control. The indicator display in the meter cluster will come on.

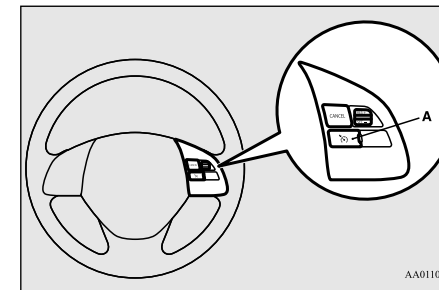

AA0110611



Cruise control*

2. Accelerate or decelerate to your desired speed, then push down and release the SET - switch (B). The vehicle will then maintain the desired speed.

The "SET" indicator appears on the information display in the meter cluster.

7

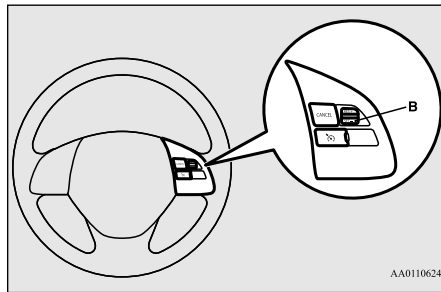

NOTE
● When you release the SET - switch (B), the vehicle speed will be set.

To increase the set speed

E00609400668

There are 2 ways to increase the set speed.

RES + switch

Push up and hold the RES + switch (C) while driving at the set speed, and your speed will then gradually increase.

7-36 Starting and driving

When you reach your desired speed, release the switch. Your new cruising speed is now set.

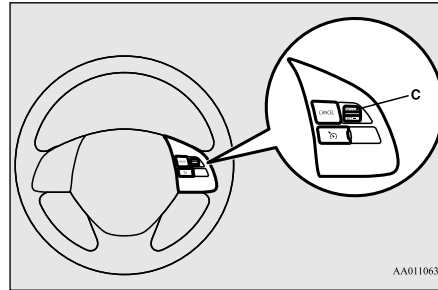

To increase your speed in small amounts, push up the RES + switch (C) for less than about 1 second and release it.

Each time you press the RES + switch (C), your vehicle will go about 1.6 km/h faster.

Accelerator pedal

While driving at the set speed, use the accelerator pedal to reach your desired speed and then push down the SET - switch (B) and release the switch momentarily to set a new desired cruising speed.

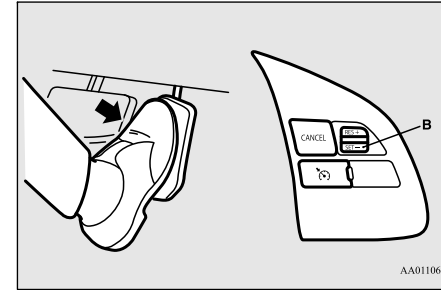

AA0110640

To decrease the set speed

E00609500584

There are 2 ways to decrease the set speed.

SET - switch

Push down and hold the SET - switch (B) while driving at the set speed, and your speed will slow down gradually.

When you reach your desired speed, release the switch. Your new cruising speed is now set.

Cruise control*

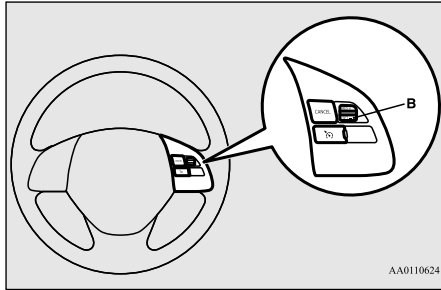

To slow down your speed in small amounts, push down the SET - switch (B) for less than about 1 second and release it. Each time you push down the SET - switch (B), your vehicle will slow down by about 1.6 km/h.

Brake pedal

While driving at the set speed, use the brake pedal, which disengages the cruise control, then push down the SET - switch (B) and release the switch momentarily to set a new desired cruising speed.

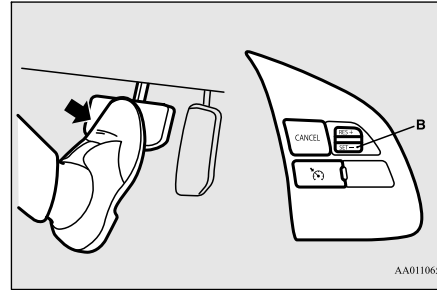

To temporarily increase or decrease the speed

E00609601234

To temporarily increase the speed

Depress the accelerator pedal as you would normally. When you release the pedal, you will return to your set speed.

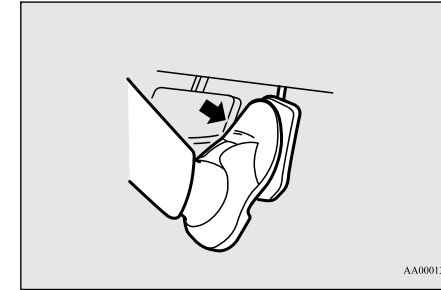

NOTE

- In some driving conditions, the set speed driving may be deactivated. If this happens, refer to “To activate” on page 7-35 and repeat the speed setting procedure.

To temporarily decrease the speed

Depress the brake pedal to decrease the speed. To return to the previously set speed, push up the RES + switch (C). Refer to “To resume the set speed” on page 7-38.

Cruise control*

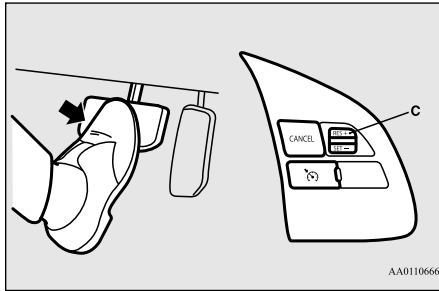

7

To deactivate

E00609702434

The set speed driving can be deactivated as follows:

- Press the CRUISE CONTROL ON/OFF switch (A) (Cruise control will be turned off.)
- Press the CANCEL switch (D).
- Depress the brake pedal.

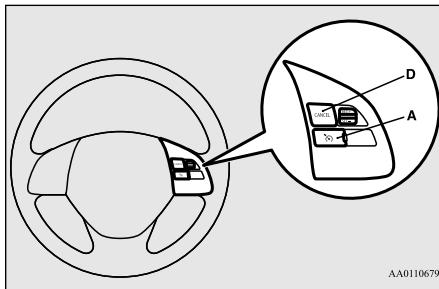

7-38 Starting and driving

The set speed driving is deactivated automatically in any of the following ways.

- When your speed slows to about 15 km/h or more below the set speed because of a hill, etc.
- When your speed slows to about 40 km/h or less.
- When the active stability control (ASC) starts operating.
Refer to “Active stability control (ASC)” on page 7-32.

⚠ WARNING

- **Although the set speed driving will be deactivated when shifting to the “N” (NEUTRAL) position, never move the selector lever to the “N” (NEUTRAL) position while driving. You would have no regenerative brake and could cause a serious accident.**

⚠ CAUTION

- When the set speed driving is deactivated automatically in any situation other than those listed above, there may be a system malfunction.
Press the CRUISE CONTROL ON/OFF switch to turn off the cruise control and have your vehicle inspected by a MITSUBISHI MOTORS Authorised Service Point.

To resume the set speed

E00609801731

If the set speed driving is deactivated by the condition described in “To deactivate” on page 7-38, you can resume the previously set speed by push up the RES + switch (C) while driving at a speed of about 40 km/h or higher. The “SET” indicator appears on the information display in the meter cluster.

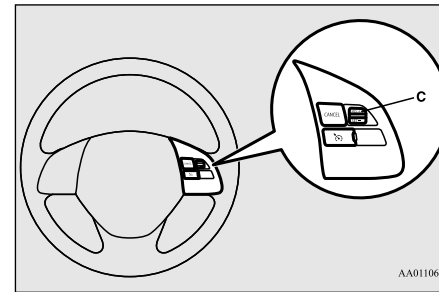

Under either of the following conditions, however, using the switch does not allow you to resume the previously set speed. In these situations, repeat the speed setting procedure:

- The CRUISE CONTROL ON/OFF switch is pressed.
- The operation mode is put in OFF.
- Indicator display go off.

Speed Limiter*

E00633201035

The Speed Limiter is a driver assist function to prevent from exceeding the speed set by driver while Plug-in Hybrid EV System power control.

CAUTION

- Because the system does not use service brake (hydraulic brake), the vehicle speed may exceed the set speed on the downhill. If a driver wants to keep the vehicle speed in such a situation, he/she must put on a service brake or downshift.

If the vehicle speed exceeds the set speed (about 3 km/h), the indicator will blink in the combination meter.

If the vehicle speed exceeds the set speed about +3 km/h more than about 5 seconds after indicated alert message, beep alert is sounded for about 10 seconds at the most.

While running without alert message, if you decrease the set speed and vehicle speed is more than set speed about +3 km/h, alert message is displayed but beep alert is delayed.

In this case, when vehicle speed keeps exceeding set speed about +3 km/h for about 30 seconds after the alert message is appeared, beep alert is sounded for about 10 seconds at the most.

If the vehicle speeds decreases less than set speeds after the alert message is appeared, the message is disappeared. When beep alert is sounding, the beep alert also goes off.

NOTE

- However, this gives priority to audio and visual signal of safety reasons or driver's demand.

Speed Limiter control switches

E00633301023

There are 4 switches which relate to the Speed Limiter on the steering wheel.

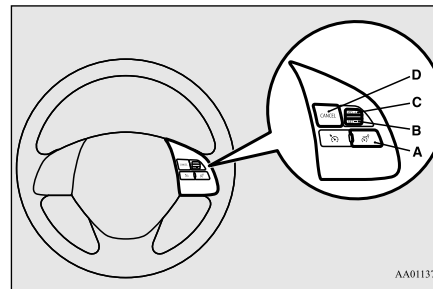

AA0113771

A-SPEED LIMITER ON/OFF switch

To turn on/off the Speed Limiter.

B-SET - switch

To set the current vehicle speed to a set speed decrease the set speed.

C-RES + switch

To resume the Speed Limiter with set speed memorized or increase the set speed.

D-CANCEL switch

To cancel the Speed Limiter.

NOTE

- Press the switch one by one.
- The Speed Limiter may be canceled automatically, if two or more switches are pressed at the same time.

7

Speed Limiter information on the multi information display area

E00633401024

The Speed Limiter information is displayed on the multi information display area in the combination meter.

Speed Limiter*

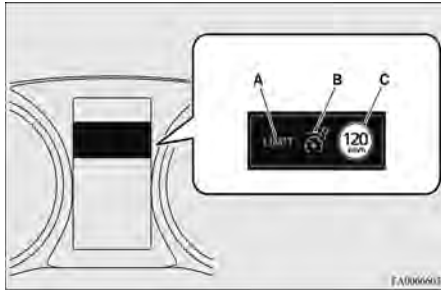

7

A-Control state

There are 3 control states as below.

LIMIT OFF

When the Speed Limiter is in STANDBY, the vehicle speed can exceed the set speed

LIMIT

When the Speed Limiter is in operation. The vehicle is controlled in order not to exceed the set speed.

OVER LIMIT

When the vehicle speed is exceeding the set speed by more than about 3 km/h

B-SPEED LIMITER ON indication

When the Speed Limiter is started up but not in operation, the Speed Limiter's symbol is appeared.

C-Set speed

Set speed is appeared if it is stored.

To start up

E00633501025

First of all, press the ON/OFF switch in order to power up the Speed Limiter when the operation mode is ON,

The Speed Limiter indication will be appeared in the combination meter.



To activate

E00633601026

Accelerate or decelerate to your desired speed, and push down the SET - switch (B). the Speed Limiter memorizes the current vehicle speed when you release the SET - switch (B). Now, the Speed Limiter starts controlling in order not to exceed the set speed.

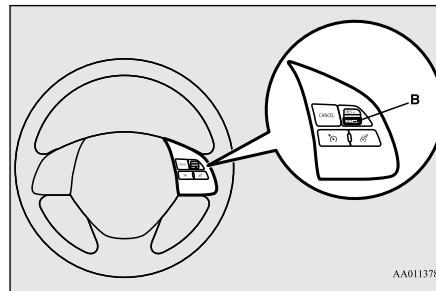

If the current vehicle speed is lower than about 30 km/h (settable minimum speed), the set speed is set at about 30 km/h.

The set speed is displayed in the combination meter.

And, control state "LIMIT" is displayed in the combination meter.



To increase the set speed

E00633700017

By using the RES + switch

E00633800018

Push up the RES + switch continuously.

Then the set speed displayed in the combination meter is gradually increased.

If the set speed reaches your desired speed, release the RES + switch (C).

Speed Limiter*

Control state "LIMIT" is displayed again and the set speed is updated.

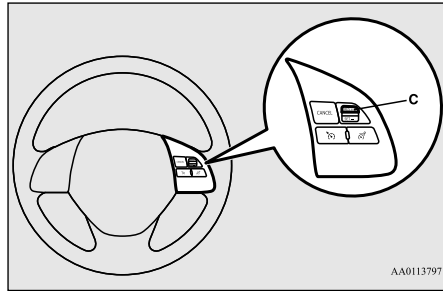

AA0113797

The set speed is increased each about 5 km/h per about 0.5 second.

If a driver wants to increase the set speed a little, push up RES + switch for less than about 0.5 second and release it.

The set speed is increased 1 km/h each taps.

By using the CANCEL switch, the accelerator pedal and the SET - switch

E00633901029

Press the CANCEL switch (D) to deactivate the Speed Limiter.

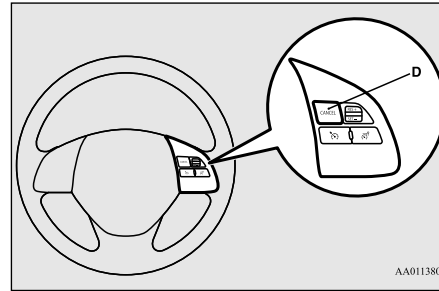

AA0113801

Control state "LIMIT" is disappeared and change control state "LIMIT OFF" in the combination meter.



Accelerate to driver's desired vehicle speed and push down SET - switch (B) and release.

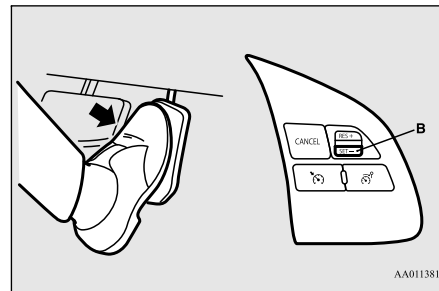

AA0113814

To decrease the set speed

E00634000017

By using the SET - switch

E00634100018

Push down the SET - switch (B).

Then the set speed displayed in the combination meter is gradually decreased.

If the set speed reaches to your desired speed, release the SET - switch (B).

7

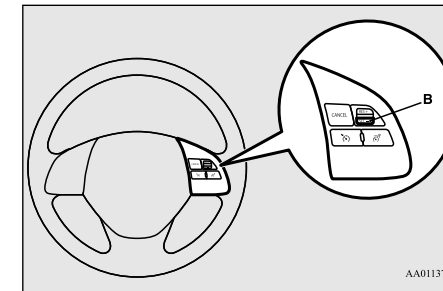

AA0113784

The set speed decrease about 5 km/h per about 0.5 second.

If a driver wants to decrease the set speed a little, press SET - switch (B) for less than about 0.5 second and release it.

The set speed is decreased 1 km/h each taps.

Speed Limiter*

By using the CANCEL switch, the service brake and the SET - switch

E00634201029

Press the CANCEL switch (D) to deactivate the Speed Limiter.

7

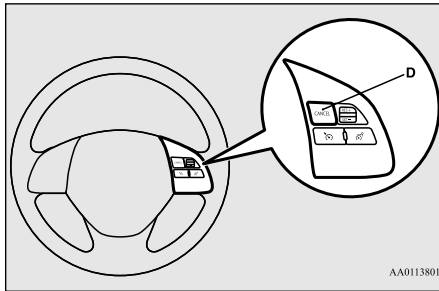

Control state "LIMIT" is disappeared and change control state "LIMIT OFF" in the combination meter.



Decelerate to driver's desired speed and push down SET - switch (B) and release.

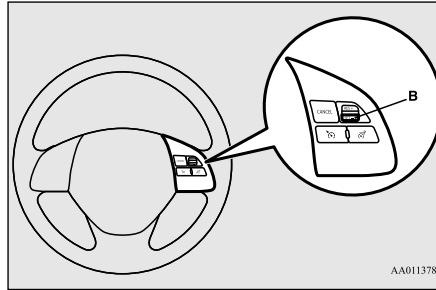

The Speed Limiter indication is displayed again and the set speed is updated.

To increase the vehicle speed temporarily

E00634301020

A driver can temporarily accelerate for emergency use.

The Speed Limiter is temporarily deactivated, and the vehicle speed can be increased.

The Speed Limiter will resume when the vehicle speed goes down to enough less than the set speed.

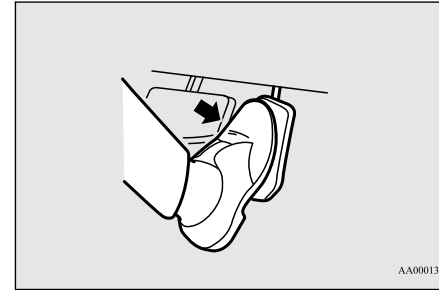

Put on an accelerator pedal to the pedal stroke end. (over a detent that makes pedal reaction force bigger before pedal stroke end)

CAUTION

- There is a possibility for the Speed Limiter to allow abrupt acceleration corresponding to accelerator pedal position. So be careful of the abrupt acceleration.

If vehicle speed exceeds set speed about +3 km/h, alert messages are appeared in the combination meter.



CAUTION

- Be careful about over speed.

NOTE

- A driver can change the set speed during this emergency use.

To deactivate

E0063440011

Use whichever following ways to deactivate. And the state of the Speed Limiter ON indication, control state “LIMIT” is displayed and the set speed is changed.

- Press CANCEL switch
- Press the Speed Limiter ON/OFF switch
- If CRUISE CONTROL ON/OFF switch or ACC ON/OFF switch is pressed, the Speed Limiter will be cancelled.

NOTE

- If the Speed Limiter is cancelled by other states, it may be a system malfunction. Stop using the Speed Limiter and turn off the Speed Limiter. Have your vehicle inspected by a MITSUBISHI MOTORS Service Point.

CAUTION

- There is a possibility for the Speed Limiter to allow abrupt acceleration corresponding to accelerator pedal position when the Speed Limiter is deactivated. Be careful.

To resume

E00634501022

The Speed Limiter memorizes the set speed when system has been deactivated, the Speed Limiter can resume by push up the RES + switch (C).

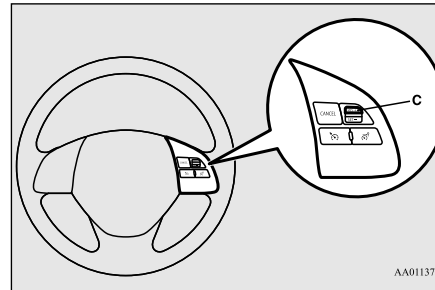

However, the Speed Limiter immediately starts controlling and the vehicle decreases as if an accelerator pedal is closed fully, when the vehicle speed is higher than the set speed.

CAUTION

- There is a possibility to occur jerk, depending on a running resistance. Be careful.

Adaptive Cruise Control System (ACC)*

Adaptive Cruise Control System (ACC)*

E00634601078

The ACC maintains a set speed with no need for you to use the accelerator pedal. Using a sensor (A), the system also measures the relative speed and distance between your vehicle and a vehicle in front, and maintains a set following distance between your vehicle and the vehicle in front by automatically decelerating your vehicle if it becomes too close to the vehicle in front.

The ACC is the driver assist system to make comfortable on a freeway. Stop lamps are illuminated during automatic braking. If you desire, a cruise control without intervention of the following distance control is also selectable.

7

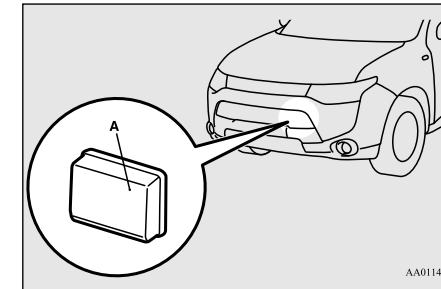

Adaptive Cruise Control System (ACC)*

NOTE

- You cannot operate the regenerative brake controls while the adaptive cruise control system (ACC) is operating. If doing so, the buzzer sounds.
- If you turn on the adaptive cruise control (ACC) when the select position is in "B" (including B0 to B5) position, the select position is changed to "D" position.

7

WARNING

- **A driver is responsible for driving safely. Even if the ACC is in use, always grasp the surrounding circumstances and provide for safe driving.**
- **Never rely solely on the ACC. The ACC is the system to reduce load on the driver. The ACC is not a collision avoidance system or an automatic driving system. The system is not intended to compensate for driver's loss of attention to the front during driving due to distraction or carelessness or supplement a drop in visibility due to the rain and fog. It is never a substitute for your safe and careful driving. Always be ready to apply the brakes manually.**

WARNING

- **This system may not correctly detect the actual situation depending on the type of vehicle in front and its conditions, the weather conditions, and the road conditions. Additionally, the system may be unable to decelerate sufficiently if the vehicle in front applies the brakes suddenly or another vehicle cuts into your path, so your vehicle approaches the front vehicle. Improper usage of this system or loss of attention to the front by the over-rely on the ACC, may result in a serious accident.**

CAUTION

- In the following situations, the system may become transiently unable to detect a vehicle in front or triggers its control and alarm functions by detecting something other than a vehicle in front.
- When driving in curved sections of road including their entrance/outlet or running beside a closed lane in a traffic work or similar zone.

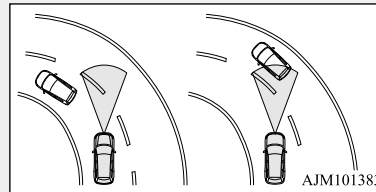

CAUTION

- When your vehicle position in a lane is instable, is frequently steered to right and left, or running unstably due to a traffic accident, trouble with some vehicles, etc.
- When driving on the road that the vehicle in front runs in offset position from your vehicle.

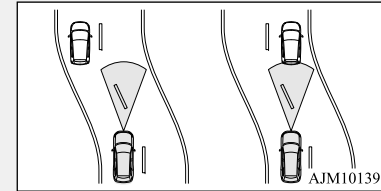

- Never use the ACC in any of the following situations. Failure to follow this instruction could lead to an accident.
- On roads with heavy traffic or roads including many windings or steep curves
- On roads with slippery surfaces, such as frozen, snow-covered, and dirt roads
- Under adverse weather conditions (rain, snow, sand storms, etc.)
- On steep downslopes
- On roads including steep up and down slopes or many changes in inclination
- In traffic requiring frequent acceleration and deceleration
- When the proximity alarm sounds frequently
- When your vehicle is towed or your vehicle tows another vehicle.

Adaptive Cruise Control System (ACC)*

CAUTION

- When your vehicle is on a chassis dynamometer or free rollers.
- When the air pressure in the tyres is not correct.
- When installing the spare tyre for emergency.
- When tyre chains are attached.
- Be sure to take the following precautions to keep the system in proper operating conditions. Improper handling of the system components may result in degraded sensor performance.
 - Avoid application of strong shock loads to the sensor and never tamper with or remove the sensor mounting screws.
 - The cover in front of the sensor and the sensor should be kept clean.
 - Do not cover the sensor mounted area of the vehicle or the sensor cover with a sticker or anything such as a grill guard etc..
 - The sensor front cover should not be modified or painted.
 - Avoid using different size tyres from those specified and maintain even tyre wear.
 - Do not modify the suspension of your vehicle.
- When the cover in front of the sensor or the sensor is deformed for an accident, please do not use the ACC and contact a MITSUBISHI MOTORS Authorised Service Point.

When ACC detects no vehicle in front within the set distance

Your vehicle runs at a speed to which you set. It is possible to set the speed between approximately 40 and 180 km/h.

NOTE

- If the vehicle speed exceed the set speed on down slope, the system automatically applies the brake to maintain the vehicle speed.
- When depressing the brake pedal while automatic brake is applied, the brake pedal is felt solidly, but it is not abnormal. You can more depress the pedal and it provides greater braking force.
- Sound is heard while automatic brake, but it is operated a brake control and not abnormal.

When ACC detects a vehicle in front within the set distance

The ACC makes control to maintain a following distance (time gap) matched with the vehicle speed between your vehicle and a vehicle in front while also activating brakes as necessary.

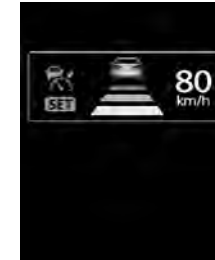

If the vehicle in front stops, the ACC reacts to it by stopping your vehicle. Depress the brake pedal as soon as your vehicle comes to a stop.

7

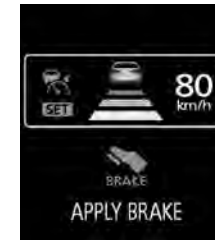

NOTE

- If you do not depress the brake pedal within 2 seconds after an automatic stop, you are alerted to automatic cancellation of the ACC by a buzzer and display message and the ACC shift into the 'standby state'. The vehicle will then start creeping as the brakes are released.

Adaptive Cruise Control System (ACC)*

⚠ CAUTION

- Never leave the vehicle during stopping by automatic braking.

When the ACC no longer detects any vehicle in front, a buzzer sounds and the symbol of vehicle running ahead disappears from the screen. The vehicle is slowly accelerated to resume the set speed and continues running at that speed.

7



⚠ WARNING

- Your vehicle may accelerate up to the set speed in the following situations. Apply the brake, if necessary, to slow down.

⚠ WARNING

- When your vehicle no longer follows the vehicle in front, e.g. at a freeway exit or when your vehicle or the vehicle in front changes its lane.

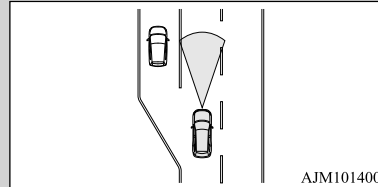

AJM101400

- When driving on a curve.



AJM101413

- If the vehicle in front turns off or changes lane and another stationary vehicle is located in front of that vehicle, the ACC will not make deceleration control to the stationary vehicle.

Proximity alarm

E00634701079

While the ACC is active, if your vehicle approaches too closely to a vehicle in front because the ACC cannot allow for an adequate deceleration in such cases as rapid

deceleration of the vehicle in front or apparition of a vehicle cutting in front of your vehicle, the ACC gives a warning by sounding a buzzer and displaying a message.

If this happens, increase the following distance by depressing the brake pedal or making other decelerating control.

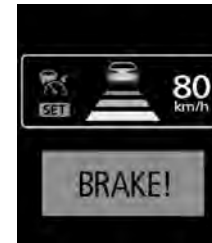

⚠ CAUTION

- When the ACC is not in use, turn off the system to prevent it from operating by mistake and an unexpected accident.
- Never operate the ACC from outside the vehicle.
- Neither control nor a warning are performed by the following situation.
 - Something other than vehicle such as a pedestrian.
 - When there is abnormality in the system (When the ACC detected abnormality, "ACC SERVICE REQUIRED" is indicated.)

CAUTION

- The ACC makes neither acceleration nor deceleration control and only issues warning in the following situation.
 - The vehicle in front is in a park or moving at an extremely slow speed.
- The ACC may not be able to maintain the set speed or the distance to a vehicle in front and may not alert the driver, if the system cannot detect the front vehicle properly in the following situations.
 - When a vehicle enters in front of your vehicle very closely.
 - When a vehicle in front is offset to the left or right.
 - When a vehicle in front is towing a trailer.
 - The vehicle in front is moving at a speed much lower than your vehicle.
 - A motorcycle or a bicycle.
 - A freight trailer that is not carrying a container.
 - The vehicle has a protruding load from the carrier.
 - The vehicle has a low vehicle height.
 - The vehicle has an extremely high ground clearance.
 - When there is repeated steep uphill and downhill driving.
 - When driving on an irregular or uneven road surface.
 - When being driven in a tunnel.
 - When you are carrying extremely heavy loads in the rear seats or luggage area.

CAUTION

- After the Plug-in Hybrid EV System starting for a while.
- When driving in curved sections of road including their entrance/outlet or running beside a closed lane in a traffic work or similar zone.
- When the cover part in front of the sensor and the sensor become dirty or adhering snow and ice*.
- When water, snow or sand on the road are extorted by the vehicle in front or an oncoming vehicle*.

*: After the ACC control has been cancelled automatically due to detection of a state of decline in performance, the ACC will not operate in the temporary condition and will inform the driver by buzzer and indication. When the ACC is in the state in which it can operate, indication is cancelled. Should indications not cancel there is a possible abnormality in the system. Please contact a MITSUBISHI MOTORS Authorised Service Point.

Adaptive Cruise Control System (ACC)*

Cruise control switch

E00634801025

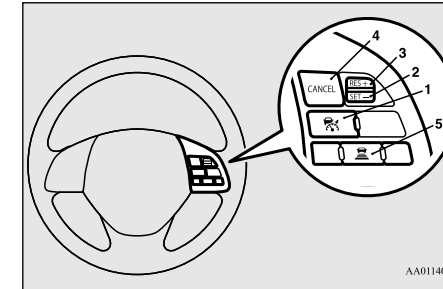

7

1- “ACC ON/OFF” switch

Used to turn on and off ACC or the cruise control function.

2- “SET -” switch

Used to set a desired speed and to reduce the set speed.

3- “RES +” switch

Used to make ACC operate at the originally set speed and also to increase the set speed.

4- “CANCEL” switch

Used to cancel the control function of ACC or the cruise control.

5- ACC distance switch

Used to change the setting of the following distance between your vehicle and a vehicle in front.

Adaptive Cruise Control System (ACC)*

NOTE

- Operate the individual switches correctly and one after another.
The ACC may be turned off or its control function may be cancelled if two or more switches are pressed concurrently.

Driving aid display

E00634901042

7



- 1- ACC indicator:**
Indicates that the ACC is ON.
- 2- Control state indicator:**
Indicates that the ACC is active.
- 3- Set speed:**
Indicates the target speed.
- 4- Vehicles in front symbol:**
Comes on when the radar detects a vehicle ahead. Two types of indication; “Stand by” and “Active”

Display	State	
	Stand by	Active
Vehicle in front detected		

- 5-Following distance setting symbol:**
Indicates the set following distance. Two types of indication; “Stand by” and “Active”

Following distance setting symbol	State	
	Stand by	Active
Long		
Middle		
Short		

How to use ACC

E00635001095

To start up (place in ‘standby state’) the system

With the operation mode set to “ON”, press “ACC ON/OFF” switch shortly to activate the ACC.

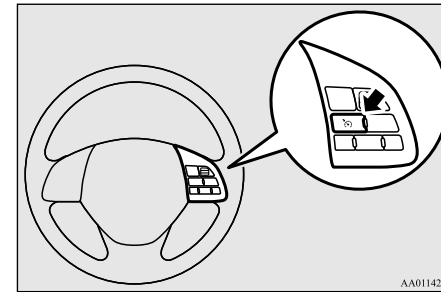

The display on the information screen of the multi-information display will switch to show information on the ACC.

When the ACC is activated, it is placed in the ‘standby state’ at which any control function is not started.

Adaptive Cruise Control System (ACC)*

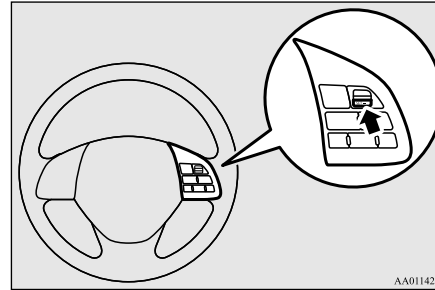

NOTE

- Even if the ACC is in the activated state when the operation mode is set to “OFF”, the system does not automatically become activated when the operation mode is set to “ON” next time.

To activate ACC control

With the ACC turned on (in the ‘standby state’), push down the “SET -” switch while driving.

When your desired speed is reached, release the “SET -” switch; then this speed is set and the ACC initiates the speed control to the set speed.

The set speed is indicated on the information screen of the multi-information display.

The ACC can be selected between approximately 40 km/h to 180 km/h.

You can set and initiate the speed control when driving at approximately 10-40 km/h while a vehicle in front is being detected. In this case, the target speed is set to 40 km/h.

Setting to any speed outside this range does not cause the ACC to start the control.

When the ACC is initialized, a buzzer sound is heard and the “SET” indicator lights up on the screen. At the same time, the display showing the following distance setting and the running-ahead vehicle symbol (only when the ACC is detecting a vehicle in front) is switched to the in-control mode display.

NOTE

- The ACC cannot start the control when any of the following conditions is present. You are alerted to this state by a sounding buzzer.
 - When the vehicle speed is lower than approximately 10 km/h or 180 km/h or higher.
 - When the vehicle is running at a speed between approximately 10 and 40 km/h and the ACC is not detecting any vehicle in front.
 - When the ASC is in the OFF state.
 - When ABS, ASC or TCL is working.
 - When the selector lever is in a position other than “D” (DRIVE).
 - While the brake pedal is being depressed.
 - When the parking brake is engaged.
 - When the system determines that its performance has been degraded due to contaminants adhered to the sensor.
 - When there is any abnormality in the system.

7

Adaptive Cruise Control System (ACC)*

To increase the set speed

There are two ways to increase the set speed.

By using the “RES +” switch:

The set speed increases by 1 km/h every time you push up the “RES +” switch while the ACC control is working. If you hold the switch pushed up, the set speed increases in 5 km/h increments.

7

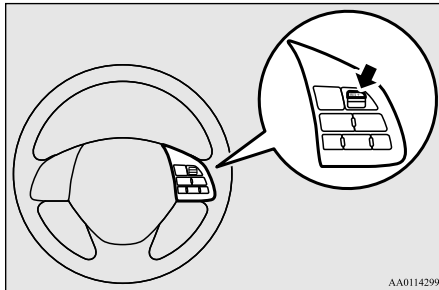

NOTE

- There is some time lag between the setting to a new speed and actually accelerating to that speed.
- Speed setting operation is possible even in presence of a vehicle in front. In this case, however, the set speed alone increases without actual acceleration taking place.

NOTE

- When the switch is held pushed, a buzzer sounds every time the set speed changes.

CAUTION

- The setting speed should be set up the suitable speed according to a situation.

By using the accelerator pedal:

When the accelerator pedal is depressed while driving with the ACC control working, you can accelerate the vehicle temporarily beyond the presently set speed.

At the point where the vehicle speed is raised to your desired speed, push down and release the “SET -” switch; the new speed is then set in the system.

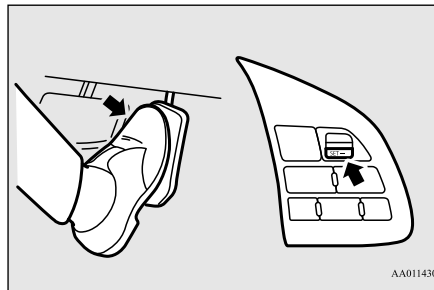

CAUTION

- The ACC braking control and proximity alarm functions will not work while the accelerator pedal is depressed.

NOTE

- The set speed indication on the display turns to “---” when the accelerator pedal is depressed. This indication remains as long as the pedal is in a depressed position.
- The ACC control at the original set speed resumes as soon as you release the accelerator pedal. Under certain conditions, however, the braking control and alarming functions of the ACC may not work for a short while after releasing the accelerator pedal.
- Set speed adjustment is impossible while the accelerator pedal is in a depressed position.

To decrease the set speed

There are two ways to decrease the set speed.

By using the “SET -” switch:

The set speed decreases by 1 km/h every time you push down the “SET -” switch while the ACC control is working. If you hold the switch pushed down, the set speed decreases in increments of 5 km/h.

Adaptive Cruise Control System (ACC)*

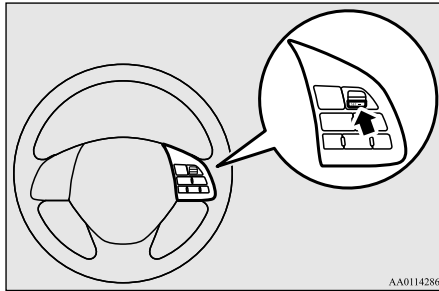

By using the brake pedal:

If you depress the brake pedal while the ACC control is working, the control is cancelled, allowing you to decelerate the vehicle. At the point where the vehicle slows down to your desired speed, push down the “SET -” switch; the new speed is then set in the system.

NOTE

- There is some time lag between the setting to a new speed and actually decelerating to that speed.
- If there is a vehicle in front and your vehicle is following that vehicle at a speed lower than the set speed, the set speed alone decreases with no actual deceleration taking place.
- When the switch is held pushed, a buzzer sounds every time the set speed changes.

CAUTION

- The setting speed should be set up the suitable speed according to a situation.

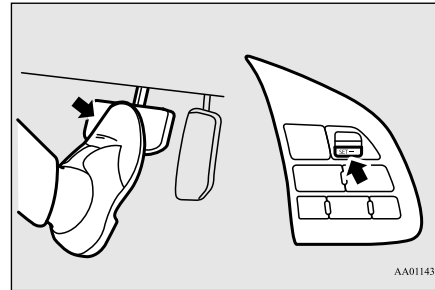

NOTE

- The ACC control is cancelled if you depress the brake pedal and the ACC control does not resume even when you release the pedal.

To temporarily accelerate the vehicle

Simply depress the accelerator pedal to temporarily accelerate the vehicle. Releasing the pedal automatically slows down the vehicle to the set speed and the ACC restarts its control.

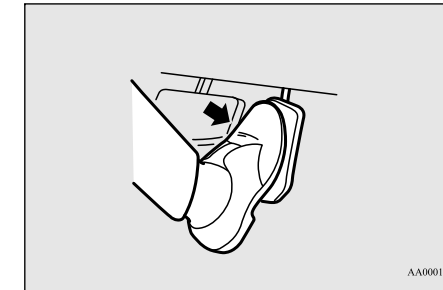

7

CAUTION

- The ACC braking control and proximity alarm functions will not work while the accelerator pedal is depressed.
- The setting speed should be set up the suitable speed according to a situation.

Adaptive Cruise Control System (ACC)*

NOTE

- The set speed indication on the display turns to “--” when the accelerator pedal is depressed. This indication remains as long as the pedal is in a depressed position.
- In certain conditions, the braking control and alarming functions of the ACC may not work for a short while after releasing the accelerator pedal.
- Set speed adjustment is impossible while the accelerator pedal is in a depressed position.

7

To terminate ACC control

To cancel of ACC control

You can cancel the ACC control by using either of the methods below.

When the control is cancelled, the system is placed in the ‘standby state’. You can make the system restart the control by using the “SET -” or “RES +” switch if the conditions for activating the control are met.

- Press the “CANCEL” switch.
- Depress the brake pedal.

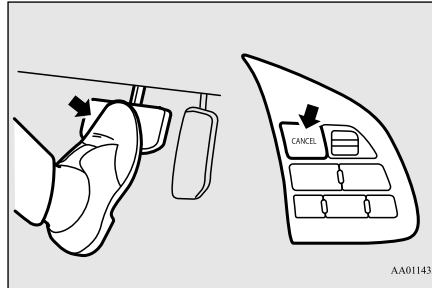

NOTE

- You can also cancel the ACC control by pressing the “ACC ON/OFF” switch. If this switch is pressed, the ACC is turned off.

When the system shifts into the ‘standby state’ as a result of cancellation of the ACC control, the “SET” indicator goes out. At the same time, the display of the following distance setting and running-ahead vehicle symbol (only when the ACC is detecting a vehicle) is placed in the standby state of display.

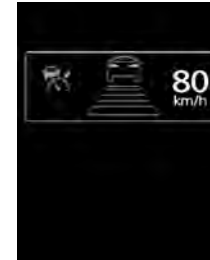

The ACC control is automatically cancelled and the ACC is placed in the ‘standby’ state in any of the situations listed below; you are alerted to this condition by the sound of a buzzer and a message on the display. You can make the system restart the control by using the “SET -” or “RES +” switch if the conditions for resuming the control are reestablished.



- When your vehicle stops as the vehicle in front stops.
- When the ASC is turned off.
- When ABS, ASC or TCL is in operation.

- When the select position is other than “D”.

WARNING

- Although the set speed driving will be deactivated when shifting to the “N” (NEUTRAL) position, never move the selector lever to the “N” (NEUTRAL) position while regenerative braking and could cause a serious accident.

- When the parking brake is engaged.
- When the ACC is self-cancelled because the system determines that its performance has declined and it cannot operate temporarily due to the following situations, the driver is informed by a buzzer and an indication on the screen.
 - Under adverse weather conditions (rain, snow, sand storms, etc.)
 - When the sensor is dirty or blocked by snow and ice.
 - When a preceding or oncoming vehicle splashes water, snow, or sand in front of the sensor.
 - The brake pads are overheating.
 - When you are driving in light traffic with few vehicles and obstacles in front.

When the ACC returns to normal operation, the indicator is cancelled. If the indicator continues, there may be a fault in the system. Please contact a MITSUBISHI MOTORS Authorised Service Point.



- When some problem occurs with the system. (In this situation, the ACC control is automatically cancelled and the system is turned off. You are alerted to this situation by the sound of a buzzer and a message on the display. If the message remains displayed even after setting the operation mode to “ON”, please contact a MITSUBISHI MOTORS Authorised Service Point.)

Adaptive Cruise Control System (ACC)*

- When some other condition which causes the control to terminate occurs. (This situation may indicate a fault. Turn off the ACC and please contact a MITSUBISHI MOTORS Authorised Service Point.)



7

To turn off ACC

Press the “ACC ON/OFF” switch when the ACC is in the ‘ON state’ to turn off the ACC.

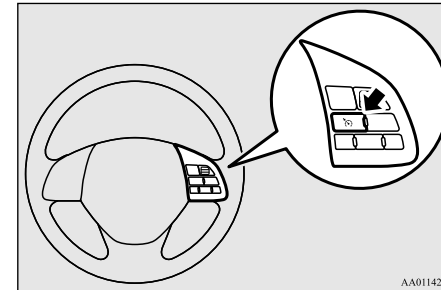

Adaptive Cruise Control System (ACC)*

NOTE

- Pressing the switch turns off the ACC even if it is engaged.
- The set speed is cancelled when the ACC is turned off or the operation mode is set to "OFF".
- If the ACC is in the 'ON state' when the operation mode is set to "OFF", the system is set to the 'OFF state' when the operation mode is set to "ON" next time.

NOTE

- The conditions to be met before the ACC control can be resumed are the same as those for starting the ACC control.

NOTE

- The following distance varies as a function of the speed; the faster the set speed, the longer the following distance.

7

To resume the control

After cancelling the ACC control (i.e. placing the system in the 'standby state') by pressing the "CANCEL" switch or depressing the brake pedal, you can resume the ACC control at the originally set speed if you push up the "RES -" switch.

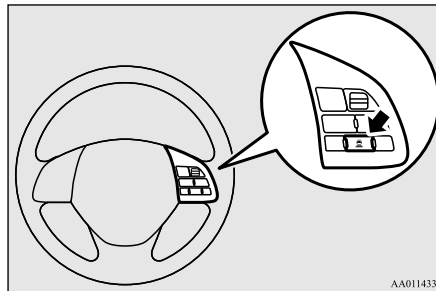
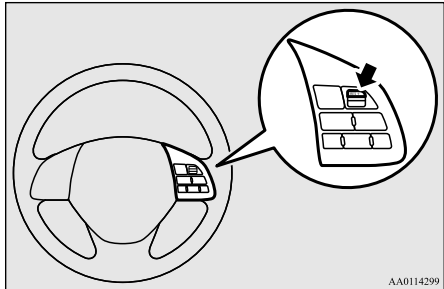

To change the following distance setting

Every time you press the following distance setting switch, the setting changes sequentially through three options "Long", "Middle" and "Short", cycling back to "Long" after "Short". The distance setting is reset when the operation mode is set to "OFF" or when the ACC is set to "OFF," and is automatically set to "long" when you set the ACC to "ON" next time.

Following distance setting: "Long"



Following distance setting: "Middle"



Following distance setting: "Short"



To activate cruise control (automatic speed control)

If you hold the "ACC ON/OFF" switch pressed with the operation mode set to "ON" and the ACC in the 'OFF state', the cruise control is activated. The information screen of the multi-information display then changes to the cruise control screen and a buzzer sounds at the same time. Cruise control is turned off if you set the operation mode to "OFF".

Forward Collision Mitigation System (FCM)*

→ Cruise control (automatic speed control system) P.7-35

CRUISE 

CAUTION

- Cruise control (automatic vehicle speed control system) does not alert by proximity alarm and control distance between vehicles to the vehicle in front.



N232158

Forward Collision Mitigation System (FCM)*

E00635101041

The FCM uses a sensor (A) to determine the distance to a vehicle in front in the same lane and its speed relative to your vehicle's speed. If the system judges that your vehicle is in danger of colliding against the vehicle almost straight from behind, it gives you visual and audible alarms (Forward collision warning function), increases the brake fluid pressure (FCM brake prefill function), and also provides braking force assistance when you

depress the brake pedal (FCM brake assist function) to avoid frontal collision.

When the risk of collision increases more, the system causes the brakes to work moderately to encourage you to apply brakes. If the system judges that a potential collision is imminent, it initiates emergency braking to mitigate collision-caused damages or to avoid possible collision (FCM braking function). Stop lamps are illuminated during automatic braking.

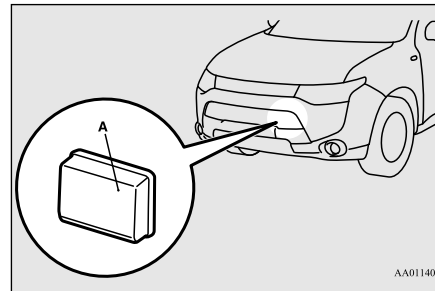

WARNING

- **A driver is responsible for driving safely.**
The FCM is the system to mitigate collision-caused damages or to avoid collisions as much as possible.
The system is not intended to compensate for driver's loss of attention to the front during driving due to distraction or carelessness or supplement a drop in visibility due to the rain and fog.
It is never a substitute for your safe and careful driving. Always be ready to apply the brakes manually.
- **The FCM works to avoid frontal collisions as much as possible.** However, the effect of its operation varies depending on situations and conditions, such as driving conditions, road conditions, and steering, acceleration and braking operations, so that the performance the function can deliver is not always the same.
If your vehicle is in danger of collision, take all necessary collision-evading actions, such as depressing the brake pedal strongly regardless of whether the system is activated or not.

7

Forward collision warning function

E00635401031

If the system judges that there is a risk of your vehicle colliding with a vehicle in front,

Starting and driving 7-55

Forward Collision Mitigation System (FCM)*

this function warns you of the potential hazard with visual and audible alarms.

When this function is triggered, a buzzer sounds and, at the same time, a “BRAKE!” message appears on the information screen of the multi-information display.

7



CAUTION

- This function does not work for a vehicle in front which is moving extremely slower than your vehicle.
- Under certain conditions, the audible alarm may not work at all or may be scarcely audible. Do not overly rely on the system; if your vehicle is in danger of collision, take all necessary collision-evading actions, such as depressing the brake pedal strongly regardless of whether the system is activated or not.

FCM brake prefill function

E00635200016

If the system judges that there is a risk of your vehicle colliding with a vehicle in front,

7-56 Starting and driving

this function prefills the brake line with additional brake fluid to make the brakes more responsive to your brake pedal operation.

FCM brake assist function

E00635301027

If the system judges that there is a risk of your vehicle colliding with a vehicle in front, this function deploys the brake assist sooner the brake assist operation.

CAUTION

- The brake assist function may not be triggered when the brake pedal is operated in certain ways. Do not overly rely on the system; if your vehicle is in danger of collision, take all necessary collision-evading actions, such as depressing the brake pedal strongly regardless of whether the system is activated or not.

FCM braking function

E00635501104

If the system judges that there is a high risk of your vehicle colliding with a vehicle in front, the system applies the brakes moderately to encourage you to apply the brakes.

If the system judges that a collision is unavoidable, it initiates emergency braking con-

trol to mitigate collision-caused damages or, if the situation permits, to avoid a collision.

When the emergency braking control is triggered, you are warned of the hazard with visual and audible alarms like with the FCM alarm function.

Once the emergency braking has worked, you are alerted to this by a message on the information screen of the multi-information display.



CAUTION

- Do not use the FCM as a normal braking.
- After your vehicle has stopped following the activation of the FCM, automatic braking is released. As the vehicle will then start creeping, be sure to depress the brake pedal to hold the vehicle stationary.
- When applying the brake during the automatic braking condition the pedal will feel firm. This is not abnormal. You can apply more pressure to the pedal to assist in braking.

Forward Collision Mitigation System (FCM)*

CAUTION

- In the following situations, the system provides neither control nor alarming.
 - The vehicle in front of your vehicle is moving at a speed much lower than your vehicle's speed.
 - When a vehicle suddenly cuts in front of your vehicle.
 - When the distance from a vehicle in front is extremely short.
 - To an oncoming vehicle.
 - When your vehicle's speed is much lower.
 - When the selector lever is other in the "D" (DRIVE) position.
 - When the system is faulty (if the system self-detects any fault, the "FCM SERVICE REQUIRED" message is indicated and the "FCM OFF" indicator lights up on the information screen of the multi-information display).
- If the message remains after the operation mode has been turned to the "OFF" position and then turned back to the "ON" position, contact a MITSUBISHI MOTORS Authorised Service Point.

**CAUTION**

- Braking function will not work in the following situations.
 - Your vehicle is driving at approximately 30 km/h or faster while the vehicle in front is stationary or moving extremely slowly.
 - The ASC is OFF.
- The forward collision warning function and/or the FCM braking function may not activate in the following situations.
 - When a motorcycle, bicycle, pedestrian, animal, fallen objects, or anything other than a vehicle is present in front of your vehicle.
 - When a vehicle suddenly appear just in front of your vehicle.
 - When a vehicle cuts in front of your vehicle very closely.
 - When the vehicle in front is offset to the left or right.
 - When the vehicle in front is towing a trailer.
 - A freight trailer that is not carrying a container.
 - The vehicle has a protruding load from the carrier.
 - The vehicle has a low vehicle height.
 - The vehicle has an extremely high ground clearance.
 - When there is a different object near the vehicle.

CAUTION

- When driving on a road with many and successive curves, including when passing their entrances and outlets.
- When accelerating and decelerating quickly.
- When the system recognizes driver's steering, accelerating, braking or gear shifting actions as evasive actions to avoid collision.
- When driving on a road with steep and alternating up and down slopes.
- When a road surface is surging, and there is unevenness.
- When being driven in a tunnel.
- When the your vehicle changed lanes, and your vehicle approached immediately behind the vehicle in front.
- During a certain time after your vehicle turns left or right.
- When you are carrying extremely heavy loads in the rear seats or luggage area.
- After the Plug-in Hybrid EV System has been running for an extended period of time.
- Under adverse weather conditions (rain, snow, sand storms, etc.)*
- When the cover part in front of the sensor and the sensor become dirty or adhering snow and ice*.
- When water, snow or sand on the road are extorted by the vehicle in front or an oncoming vehicle*.

Forward Collision Mitigation System (FCM)*

7

CAUTION

*: When judging the state that detection performance deterioration and the FCM can't operate temporarily by these situations automatically, "FCM TEMPORARILY NOT AVAILABLE" message is indicated, and a "FCM OFF" indicator lights up.

Additionally, it may be indicated in the following situations.

- When the brake is over heating.
- When you are driving in light traffic with few vehicles and obstacles in front.

When the FCM will be in the state which can operate, indication is released automatically. When indication keeps going out, there is an abnormal possibility of the system. Please contact a MITSUBISHI MOTORS Authorised Service Point.



- Factors such as the positional relationship between your vehicle and a vehicle in front, driver's own technique of steering the vehicle and irregularly moving traffic due to accidents or vehicle trouble may deter the FCM control and alarm from functioning.

CAUTION

- When the system recognizes driver's steering or accelerating actions as evasive actions to avoid collision, the FCM control and alarm functions may be canceled.
- The FCM control and alarm functions may be triggered in the following situations.
 - When there is a structure (B) beside the entrance of a curve and intersection.

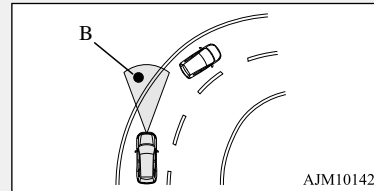

- When running on a narrow iron bridge.
- When passing through a gate with small head or side clearances.
- When there are metallic objects, steps or projections on the road surface.
- When quickly approaching a vehicle in front to overtake it.
- When passing an electronic toll collection gate.
- When running under an overpass, an pedestrian overpass or a small tunnel.
- When running in Multi-storey car park.
- When running the road the gradient changes suddenly.
- When stopping very close to a wall or a vehicle in front.

CAUTION

- When passing close to the vehicle or an object.

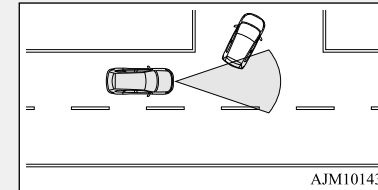

- When driving on the road that the vehicle in front runs in offset position from your vehicle.

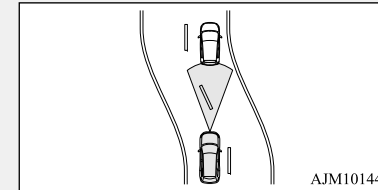

- Turn off the system beforehand when the vehicle is placed in any of the following situations as the system can operate unexpectedly.
 - When your vehicle's wheels are driven by the Plug-in Hybrid EV System on a lift.
 - When your vehicle is towed or your vehicle tows another vehicle.
 - When your vehicle is carried on a truck.
 - When enjoying sports driving on a circuit.
 - When your vehicle is on a chassis dynamometer or free rollers.
 - When the tyre pressure is not proper.

Forward Collision Mitigation System (FCM)*

CAUTION

- When installing the spare tyre for emergency.
- When tyre chains are attached.
- Improperly handling the system components may result in such problems as degraded sensor performance and ultimately in an accident. Be sure to take the following precautions to keep the system in good operating conditions.
- Avoid application of strong shock loads to the sensor and never tamper with or remove the sensor mounting screws.
- The cover in front of the sensor and the sensor should be kept clean.
- Do not cover the sensor mounted area of the vehicle or the sensor cover with a sticker or anything such as a grill guard etc..
- The sensor front cover should not be modified or painted.
- Avoid using different size tyres from those specified and maintain even tyre wear.
- Do not modify the suspension of your vehicle.
- If the sensor mounted area of the vehicle is deformed due to an accident or some other causes, turn off the system and please contact a MITSUBISHI MOTORS Authorised Service Point.

NOTE

- A sound will be heard during the activation of automatic braking, this is a function of the brake control and is not abnormal.

FCM ON/OFF switch

E00635601062

This switch is used to turn on and off the FCM and also to select your desired collision alarm timing.

When the switch is held pressed, the ON/OFF state of the FCM changes from ON to OFF and vice versa. If you give the switch a short press with the FCM in the ON state, you can change the collision alarm timing.

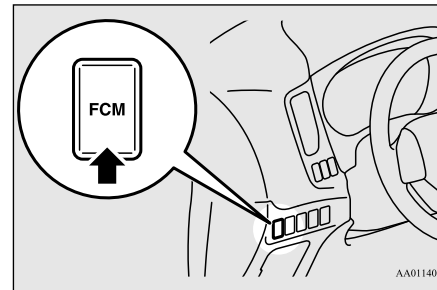

To turn on/off the system

You can switch the system from OFF to ON or ON to OFF if you hold the FCM ON/OFF switch pressed when the operation mode is set to "ON".

Once the system is turned on, a buzzer sounds, the information screen of the multi-information display shows the collision alarm timing currently selected, and the "FCM OFF" indicator on the screen goes out.

7



When you turn off the system, a buzzer sound and, at the same time, the "FCM OFF" message appears on the screen and the "FCM OFF" indicator comes on.



Cycling the operation mode to ON will set the FCM back ON.

Lane Departure Warning (LDW)*

To change alarm timing

Give a short press to the FCM ON/OFF switch to change the timing at which the frontal collision alarm is triggered. Every time you press the switch, the alarm timing changes alternately between “FAR” (earlier alarming) and “NEAR” (later alarming).

As you make selection, the selected alarm timing is displayed on the information screen of the multi-information display. Even after turning off the FCM or setting the operation mode to “OFF”, the system retains your last selected alarm timing in memory.

7

When “NEAR” is selected



When “FAR” is selected



CAUTION

- For the FCM brake prefill, the FCM brake assist and the FCM braking functions, the function triggering timing cannot be changed.



Lane Departure Warning (LDW)*

E00635701021

By recognizing through a camera (A) the lane in which your vehicle is running, LDW gives you warning when your vehicle is likely to drift from its lane with an audible alarm and a visual alarm displayed on the information screen of the multi-information display.

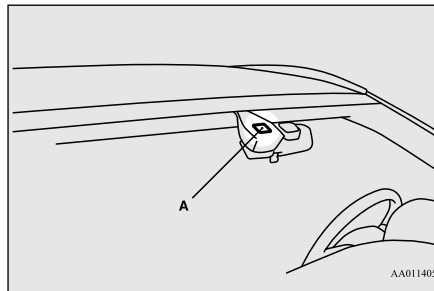

AA0114055

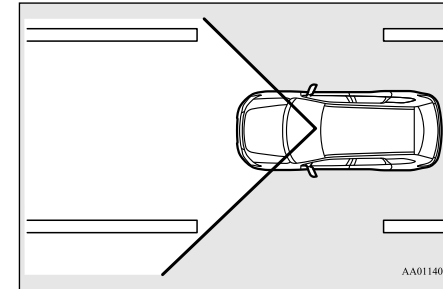

How to operate LDW

E00635801022

The indication on the information screen of the multi-information display changes as follows depending on the state of the system.

Turning on the system

When you set the operation mode to “ON”, the “LDW” indicator appears on the information screen of the multi-information display, showing that the system is placed in the ‘ON state’.

Lane Departure Warning (LDW)*



Turning off the system

When you press the LDW switch, the “LDW” indicator on the information screen of the multi-information display goes out, showing that the system is placed in the ‘OFF state’. Press the switch again, the system returns to “ON”.

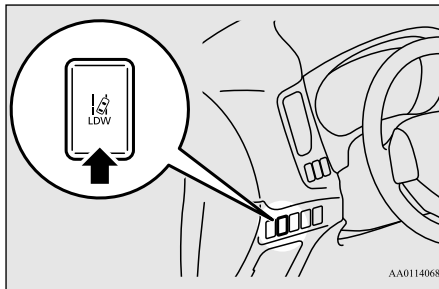

NOTE

- When you set the operation mode to “OFF” with the system “OFF,” the system will be restored “ON.”

Standby state

In the standby mode, the system is capable of recognizing the lane in which your vehicle is positioned and issuing audible warning when your vehicle goes out of the lane. The system automatically shifts from the ‘ON state’ to the ‘standby state’ if all of the following conditions are simultaneously met. The “LDW” indicator in the information display change to  indicator (green).

- The vehicle speed is approximately 65 km/h or higher.
- The turn-signal lever is not operated.
- The hazard lamp is not activated.
- The brake pedal is not depressed.
- Environmental conditions are adequate for the system to recognize the lane markings on both sides.
- The system has been placed in the ‘ON state’.



NOTE

- The system stays in the “ON” state for about 7 seconds after the hazard lamp has stopped flashing or the turn-signal lever has returned to the home position.

7

Lane departure warning

A buzzer sounds intermittently and indication of “LANE DEPARTURE” appears in the information display,  indicator flashing in amber when your vehicle is about to leave or has left the lane in the standby mode.



Lane Departure Warning (LDW)*

NOTE

- If warning continues for about 10 seconds or more, the system switches to the standby mode before the warning stops.

System problem warning

E00635901023

If a problem occurs with the system, a visual warning specific to the type of the problem is given together with an audible alarm.

7

Too hot LDW camera

The alarm shown below is displayed if the system becomes temporarily unable due to too high a temperature of the LDW camera. If the camera cools down below the predetermined temperature, the system automatically recovers the normal state.



NOTE

- The warning message can be cleared temporarily by setting the LDW switch to "OFF."

LDW deactivation due to fault

The alarm shown below is displayed if LDW becomes to a non-initialized state due to a fault.

If this happens, please contact a MITSUBISHI MOTORS Authorised Service Point for inspection of the system.



CAUTION

- LDW has its performance limitations. Do not over-rely on the system.
- LDW is not designed to lessen risks associated with not looking ahead carefully (attention drawn to something on the side, absentmindedness, etc.) or poor visibility caused by bad weather etc. Keep steering your vehicle correctly and drive safely.

CAUTION

- The system may not be able to detect the lane correctly in the following conditions. If required, set the LDW switch to "OFF."
 - When driving on a road whose lane markings (white or yellow) are worn out or smeared with dirt to an extent not recognizable by the system.
 - When lane markings are vague, typically during a drive in the rain, snow or fog, or when running against the sun.
 - When the vehicle is moving in a place where lane markings are interrupted, such as a toll booth entrance and motorway junction.
 - When running on a road portion with incompletely removed old lane markings, shadows, lingering snow, truck-like puddles mistakable for lane markings (especially after the rain when road surface is reflecting light) or similar confusing factors.
 - When running in a lane other than the cruising lane and passing lane.
 - When running beside a closed lane section or in a provisional lane in a traffic work zone.
 - When running in an extremely narrow lane.
 - When the following distance between your vehicle and a vehicle in front becomes extremely reduced (especially when a marking is hidden by a vehicle in front this is running too close to the marking).
 - When entering a junction or other point of road where lanes are laid out complicatedly.

Reversing sensor system*

CAUTION

- When passing a road section where the number of lanes increases/decreases or multiple lanes are crossing each other.
- When the lane is marked by double or otherwise special lines.
- When driving on a winding or rough road.
- When driving on a slippery road covered by rain water, snow, ice, etc.
- When passing through a place where the brightness suddenly changes, like the inlet or outlet of a tunnel.
- When turning steep curves.
- When the road surface is reflecting the light shining from the direction opposite to the running direction.
- Vehicle largely lurches when it is running over steps or other irregularities of the road surface.
- When the headlamp illumination is inadequate because of contaminated or deteriorated lenses or improperly aimed headlamps.
- When the vehicle is leaning much to one side due to heavy luggage on it or improperly adjusted tyre pressures.
- When oncoming vehicles' headlamps shine the LDW camera.
- When the vehicle is equipped with non-standard tyres (including excessively worn tyres), uses snow traction device (tyre chains), or has non-specified components such as a modified suspension.

CAUTION

- When the windscreen is covered with rain water, snow, dust, etc.
- Follow the instructions given below to keep your LDW in good operating conditions.
 - Always keep the windscreen clean.
 - Avoid applying a strong shock or pressure to the LDW camera. Do not attempt to disassemble it.
 - Disturbing the installation of the LDW camera or its removal is under no circumstances permitted. The camera has been precisely oriented at the factory.
 - Do not put anything like a sticker on the area in front of the LDW camera lens of the windscreen.
 - Use only MITSUBISHI MOTORS GENUINE Parts when replacing the windscreen wipers.

Reversing sensor system*

E00615500374

This system operates when you are backing the vehicle. It uses corner and back sensors to detect an obstacle and the information screen in the multi information display and the buzzer to inform you of the approximate distance to the obstacle.

CAUTION

- The reversing sensor system assists you in determining the approximate distance between the vehicle and an obstacle located behind the vehicle. It has limitations in terms of detectable areas and objects, and may not properly detect some objects. Therefore, do not place excessive confidence in the reversing sensor system, and operate the vehicle as carefully as you would a vehicle without this system.
- Make sure to check the surroundings with your own eyes to ensure safety. Do not operate the vehicle by relying on the reversing sensor system alone.

7**Obstacle detection areas**

E00615601473

The detection areas of the corner and back sensors are limited to those shown in the illustration. Moreover, the sensors are unable to detect low or thin objects or objects near the rear bumper. Thus, make sure to check the surroundings as you operate the vehicle in a safe manner.

Corner and back sensor locations

There are two corner sensors (A) at the corners of the rear bumper, and two back sensors (B) in the centre of the rear bumper.

Starting and driving 7-63

Reversing sensor system*

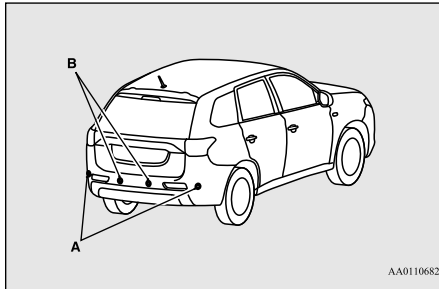

7

Reversing sensor system detection areas

Depending on whether the vehicle is equipped with a towbar, you can change the reversing sensor system between the standard mode and the towbar mode. The towbar mode changes the system to exclude the area in which the towbar is mounted from the detection areas.

Vehicles without a towbar

The detection areas are within approximately 60 cm (A) from the corner sensors, 150 cm (B) from the back sensors, and 60 cm (C) or less from the ground surface, excluding the area approximately 10 cm (D) from the ground surface.

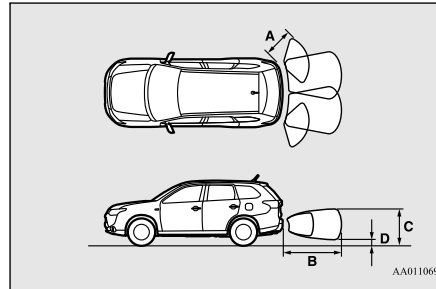

Vehicles with a towbar

The detection areas are within approximately 60 cm (A) from the corner sensors, 150 cm (B) from the back sensors, and 60 cm (C) or less from the ground surface, excluding the area approximately 10 cm (D) from the ground surface. The non-detection areas (E) are within approximately 20 cm (F) from the bumper.

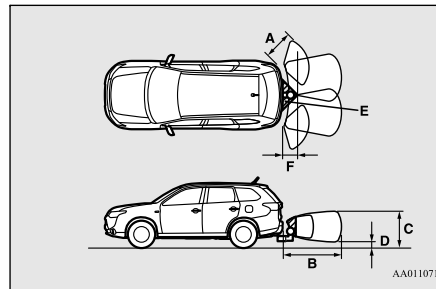

NOTE

- If the rear bumper has been exposed to an impact, the corner or back sensors may fail and prevent the system from functioning properly. Have the vehicle inspected at a MITSUBISHI MOTORS Authorised Service Point.
- The sensors do not detect objects located in the area directly below or near the bumper. If the height of an object is lower than the mounted position of the corner or back sensors, the sensors may not continue detecting it even if they detected it initially.

For information on how to change the detection areas, please refer to “Changing the detection areas” on page 7-66.

CAUTION

- The reversing sensor system may not operate properly under the following conditions:
 - The sensors or surroundings are covered with ice, snow, or mud.
 - The sensors are frozen.
 - The system receives ultrasonic noise from other sources (the horns of other vehicles, motorcycle engines, brakes, radios, pouring rain, splashing water, snow traction device (tyre chains), etc.).
 - The sensors are extremely hot or cold (while the vehicle is parked for a long period of time under a blazing sun or in cold weather).

Reversing sensor system*

CAUTION

- The vehicle tilts significantly.
- The vehicle is driven on a rough road (with a bumpy, gravel, hilly, or grassy surface).
- The vehicle is too close to an obstacle.
- The sensors or surroundings have been wiped by hand, or stickers or accessories have been attached.
- The reversing sensor system may not properly detect the following:
 - Objects that are thin, such as wire nets or ropes.
 - Objects that absorb sound waves, such as snow.
 - Objects that are shaped with a sharp angle.
 - Objects with a smooth surface, such as glass.
 - Objects that are low, such as kerbstones.

NOTE

- The buzzer may sound lower than the normal warning sound when the reversing sensor system is receiving ultrasonic noise from other sources, but this is not a malfunction. The buzzer will stop sounding and the system will return to normal operation after the noise is no longer received.

To operate

E00615701823

To operate the system, move the selector lever to the “R” position while the operation mode is put in ON. When the reversing sensor system is operated, the reversing sensor system operation indicator lamp (A) will turn on. To stop the operation, push the “SONAR” switch; the reversing sensor system operation indicator lamp (A) is turned off.

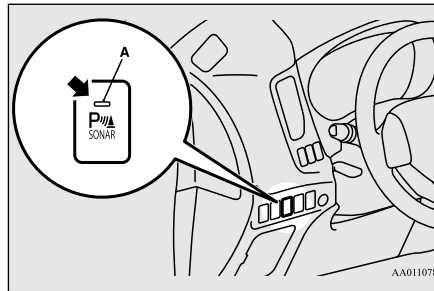

AA0110783

NOTE

- Only when the select position is the “R” position, the reversing sensor system can be operated or be stopped by using the “SONAR” switch.

Warning for obstacles

If there is an obstacle behind the vehicle, a warning will be issued with the information screen in the multi information display and a warning buzzer.

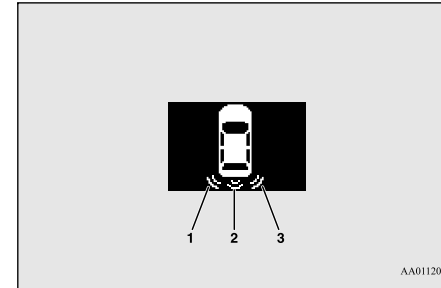

AA0112019

- 1- Corner sensor (left)
- 2- Back sensor
- 3- Corner sensor (right)

Corner sensor

Vehicle to obstacle distance	Warning display/sound cycle
Approx. 60 to 40 cm	Intermittent
Approx. 40 to 20 cm	Fast intermittent
Within approx. 20 cm	Continuous

Reversing sensor system*

Back sensor (vehicles without a towbar)

Vehicle to obstacle distance	Warning display/sound cycle
Approx. 150 to 80 cm	Intermittent
Approx. 80 to 40 cm	Fast intermittent
Within approx. 40 cm	Continuous

NOTE

- When the sensors are detecting different obstacles at the same time, the information screen in the multi information display indicates the directions of the obstacles each sensors are detecting. However, closer obstacles are given priority over other detected obstacles and the warning buzzer sounds to inform you of closer obstacles.

NOTE

- The detection area will not change if you keep the “SONAR” switch pushed for 10 seconds or more.
- After pushing the “SONAR” switch, reversing sensor system operation differs according to the detection area setting.
 - Setting when towbar is not equipped
When the selector lever is moved to the “R” position, the reversing sensor system will operate even if corner sensor operation was stopped by pushing the “SONAR” switch.
 - Setting when towbar is equipped
When reversing sensor system operation was stopped by pushing the “SONAR” switch, the reversing sensor system will not operate until the Plug-in Hybrid EV System has been stopped even if the selector lever is moved to the “R” position.
To resume reversing sensor system operation, push the “SONAR” switch or stop and restart the Plug-in Hybrid EV System, and then move the selector lever to the “R” position.

7

Back sensor (vehicles with a towbar)

Vehicle to obstacle distance	Warning display/sound cycle
Approx. 150 to 100 cm	Intermittent
Approx. 100 to 60 cm	Fast intermittent
Within approx. 60 cm	Continuous

Changing the detection areas

E00615801257

The detection areas can be changed as follows:

Vehicles with a towbar

While the operation of the system is stopped at the “SONAR” switch, push the “SONAR” switch approximately 3 seconds or more, and release it. The buzzer sounds twice to indicate that the detection area has been changed.

Vehicles without a towbar

While the operation of the system is stopped at the “SONAR” switch, push the “SONAR” switch approximately 3 seconds or more, and release it. The buzzer sounds once to indicate that the detection area has been changed.

CAUTION

- The distances given are to be used for reference only, as errors may be caused by various factors, such as temperature, humidity, or the shape of the obstacles.

Reversing sensor system warning display

E00615900323

In case there is a malfunction in the reversing sensor system, the display for the malfunctioning sensor will blink and the warning buzzer will sound for approximately 5 sec-

onds. Even after the buzzer and display has stopped warning, the indicator lamp (A) on “SONAR” switch will continue blinking until the system reverts to the normal state. Have the vehicle inspected at a MITSUBISHI MOTORS Authorised Service Point.

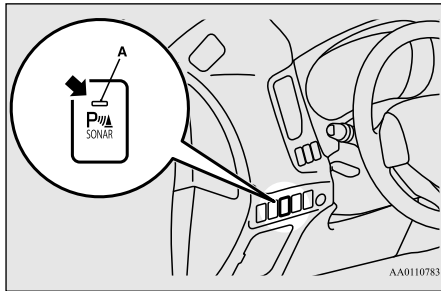

Rear-view camera*

E00618401603

The rear-view camera is a system that shows the view behind the vehicle on a screen of the Mitsubishi Multi Communication System (MMCS) or the DISPLAY AUDIO.

CAUTION

- The rear-view camera is an assistance system that enables the driver to check for obstacles behind the vehicle. Its range of view is limited, so you should not overly depend on it. Please drive just as carefully as you would if the vehicle did not have the rear-view camera.
- Be sure to visually confirm safety around the vehicle with your own eyes. Do not depend entirely on the rear-view camera.

Range of view of rear-view camera

The range of view of the rear-view camera is limited to the area shown in the illustrations. It cannot show the both sides and the lower part of the rear bumper, etc. When reversing, be sure to visually confirm safety around the vehicle.

Location of rear-view camera

The rear-view camera (A) is integrated into the part near the tailgate handle.

Rear-view camera*

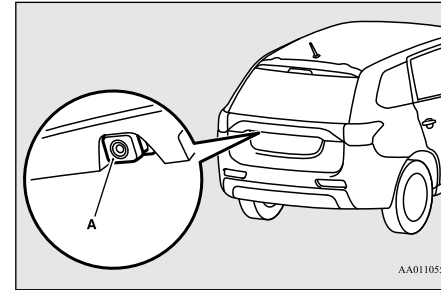

AA0110552

7

Range of view of rear-view camera

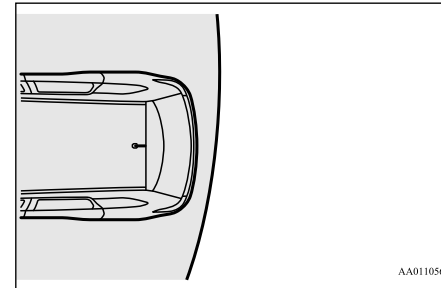

AA0110565

Rear-view camera*

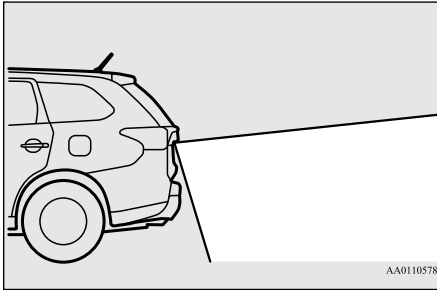

7

How to use the rear-view camera

When you place the select position is the “R” position with the operation mode in ON, the view behind the vehicle will automatically appear on the screen of the Mitsubishi Multi Communication System (MMCS) or the DISPLAY AUDIO. When you move the selector lever to any other position, the screen will return to its original indication.

CAUTION

- The rear-view camera has a special lens that can make objects shown on the screen appear to be closer or further away than they actually are.

NOTE

- Because the rear-view camera has a special lens, the lines on the ground between parking spaces may not look parallel on the screen.
- In the following situations, the screen indication may be difficult to see. There is no abnormality.
 - Low light (nighttime)
 - When the light of the sun or the light from a vehicle’s headlamps shines directly into the lens
- If the camera is hot and is then cooled by rain or a car wash, the lens can mist up. This phenomenon does not indicate a malfunction.
- It is not possible to fully see obstacles when the lens is dirty. If the lens becomes contaminated by water droplets, snow, mud, or oil, wipe off the contamination, taking care not to scratch the lens.
- Please observe the following cautions. Ignoring them could lead to a camera malfunction.
 - Do not subject the camera to physical shock.
 - Do not apply wax to the camera.
 - Do not splash the camera with boiling water.
 - Do not disassemble the camera.

Reference lines on the screen

Reference lines and upper surface of the rear bumper (A) are displayed on the screen.

- Red line (B) indicates approximately 50 cm behind the rear bumper.
- Two Green lines (C) indicate approximately 20 cm outside of the vehicle body.
- Short transverse lines (1 to 3) indicate distance from the rear bumper.

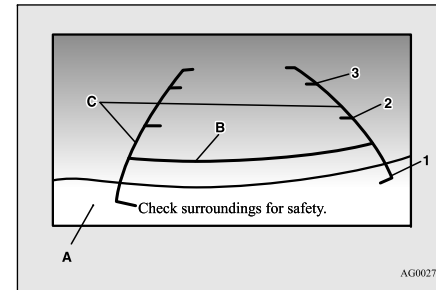

- 1: Approximately at the rear edge of the rear bumper
- 2: Approximately 100 cm
- 3: Approximately 200 cm

Rear-view camera*

NOTE

- It is possible to change the display language of the screen.
For details, please refer to the separated owner's manual for "Mitsubishi Multi Communication System (MMCS)".
- When the vehicle is tilting because of the number of people in the vehicle, the weight and positioning of luggage, and/or the condition of the road surface, the lines in the view from the rear-view camera may not be accurately positioned relative to the actual road. The reference lines for distance and vehicle width are based on a level, flat road surface. In the following cases, objects shown on the screen will appear to be farther off than they actually are.
- When the rear of the vehicle is weighed down with the weight of passengers and luggage in the vehicle.

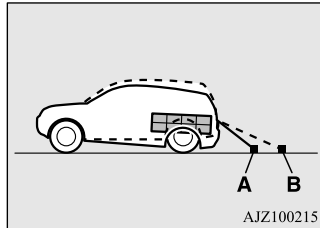

A: Actual objects
B: Objects shown on the screen

NOTE

- When there is an upward slope at the back.

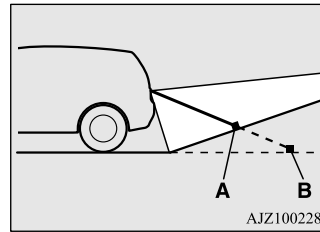

A: Actual objects
B: Objects shown on the screen

NOTE

- The reference lines for distance and vehicle width are intended to indicate the distance to a flat object such as a level, flat road surface. This may make the distance to a projecting object shown on the screen differ from the actual distance to the projecting object. Do not use them as a guide to distances to solid objects.
Example: On the screen the point B appears the nearest, then the point C and A in order of distance. The point A and B actually are the same distances from the vehicle, and the point C is farther off than the point A and B.

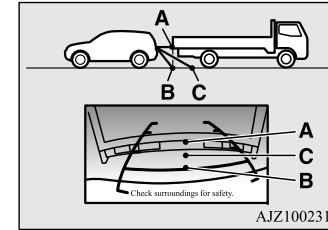

AJZ100231

Cargo loads

Cargo loads

E00609902566

Cargo loads precautions

CAUTION

- Do not load cargo or luggage higher than the top of the seatback. Be sure that your cargo or luggage cannot move once your vehicle is moving. Having the rear view blocked, and your cargo being thrown inside the cabin if you suddenly have to brake can cause a serious accident or injury.
- Load heavy cargo or luggage in the front of the vehicle. If the load in the back of the vehicle is too heavy, steering may become unstable.

Loading a roof carrier

CAUTION

- Use a roof carrier that properly fits your vehicle. Do not load luggage directly onto the roof.
For installation, refer to the instruction manual accompanying the roof carrier.

NOTE

- We recommend you to use a MITSUBISHI MOTORS GENUINE roof carrier, since the brackets to be used have a special shape. For details, we recommend you to consult a MITSUBISHI MOTORS Authorised Service Point.

Roof carrier precaution

CAUTION

- Make sure that the weight of the luggage does not exceed the allowable roof load. If the allowable roof load is exceeded, this may cause damage to the vehicle. The roof load is the total allowable load on the roof (the weight of the roof carrier plus the weight of luggage placed on the roof carrier).
For the specific value, refer to "Maximum roof load" on page 12-5.

CAUTION

- When luggage is loaded onto the vehicle, please make sure to drive slowly and avoid excessive maneuvers such as sudden braking or quick turning.
In addition, place the luggage on the carrier so that its weight is distributed evenly with the heaviest items on the bottom. Do not load items that are wider than the roof carrier. The additional weight on the roof could raise the vehicle's centre of gravity and affect vehicle handling characteristics.
As a result, driving errors or emergency maneuvers could lead to a loss of control and result in an accident.
- Before driving and after travelling a short distance, always check the load to make sure it is securely fastened to the roof carrier. Check periodically during your travel that the load remains secure.

NOTE

- To prevent wind noise or reduction in fuel economy, remove the roof carrier when not in use.
- Remove the roof carrier before using an automatic car wash.
- Be sure that adequate clearance is maintained for raising the sunroof (if so equipped) and/or the tailgate when installing a roof carrier.

Towing caravans and trailers

Towing caravans and trailers

E00610401405

Your vehicle has qualities which make it well suited for normal towing operations provided a few recommendations are observed. These are primarily concerned with the prevention of overloading of the vehicle and with the selection of the proper equipment. If these precautions are taken and driving habits are regulated accordingly, the effects of towing trailers and caravans can be minimized.

It should be noted that damage to the vehicle caused directly or indirectly by operating under conditions outside the limits set out on this page will void the warranty, relative to such damage.

⚠ WARNING

- **When connecting the trailer with Electric Trailer Brake (ETB), use MITSUBISHI MOTORS GENUINE ETB harness.**
- **If using an ETB harness other than MITSUBISHI MOTORS GENUINE parts, an unexpected reduction in drive force may occur when using the manual trailer brake override which could lead to instability and increase the risk of an accident.**

⚠ CAUTION

- MITSUBISHI MOTORS recommends the use of MITSUBISHI MOTORS towing equipment where it is available. No recommendation is made as to the make of equipment which may be used if MITSUBISHI MOTORS equipment is not available.
- The loads specified apply only if a MITSUBISHI MOTORS GENUINE Parts Tow Bar and other specified equipment is used.

State regulations

The legal authorities require that a trailer or caravan be fitted with stop, tail and turn signal lamps. An electrical kit can be fitted by your authorized MITSUBISHI MOTORS dealer which meets legal requirements and can be left on your vehicle permanently. It may be necessary to fit additional rear vision mirrors to both sides of your vehicle to give clear vision past your trailer or caravan. Ensure that your trailer or caravan complies with the regulations of the particular State in which you are travelling, e. g. lighting, safety chains, brakes, mass, etc. Check that your towbar tongue does not obscure your vehicle's number plate when the trailer or caravan is disconnected. If it does, remove the tongue ensuring that it is refitted securely when refitted.

Permissible towing load and requirements

The maximum payload of the towing vehicle does not exceed the requirements of each maximum mass described in the "Vehicle mass". See "Specifications" for the payload information.

⚠ CAUTION

- The trailer brake and towing hitch requirements as specified are minimum requirements only and MITSUBISHI MOTORS recommend that a trailer brake and a load distributing hitch is used whenever you are towing, to improve stopping distance and towing stability.
When using a load distributing hitch the load on the trailer tyres increases. Do not exceed the trailer tyre load rating.
With all towing operations it is important to limit the towing vehicle payload as noted. Failure to do so may result in exceeding the maximum load rating of the tyres. This rating is marked on the tyre placard and may also be displayed on the tyre sidewall.

7

Setting up for towing

Having established compliance with the State regulations for permissible towing loads and

Starting and driving 7-71

Towing caravans and trailers

brake/hitch requirements, adjust the position of the load in the trailer to achieve the specification requirements.

Select the appropriate hitch combination which is to be used in conjunction with the MITSUBISHI MOTORS approved parts tow-bar. If you use the load distributing hitch, it must be installed in accordance with the manufacturer's instructions.

7

It is recommended that two safety chains are used. The chains should be **crossed** under the trailer draw bar so that the draw bar is prevented from touching the ground if it becomes detached from the vehicle. The chains must not stop the trailer from turning freely. Correct load rated shackles must be used to attach the chains. In some states and territories, a single safety chain is permitted by regulation. Be sure it is attached with correct load rated shackles.

For further information about the selection and use of towing equipment, consult a MITSUBISHI MOTORS Authorised Service Point.

Example

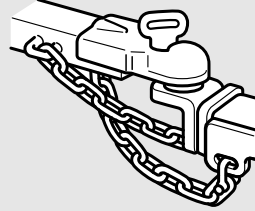

AA0007267

Operating hints

Vehicle preparation

Have your vehicle serviced prior to towing a heavy trailer or caravan, taking particular care of the state of Plug-in Hybrid EV System tune, the condition of brakes, steering and tyres.

Adjust tyre pressures to those quoted for a fully laden vehicle (see Tyre placard).

Check the tyres, wiring and brakes (if fitted) on the caravan / trailer.

Have the cooling system checked and ensure that the radiator intake is clear to allow maximum air flow through the radiator. Do not

place restrictions in front of the radiator (water bags, driving lamps, insect screens, non MITSUBISHI MOTORS approved bull-bars, etc.) as they restrict air flows.

Check that tow bar fixing bolts are tightened to specification.

After a loaded caravan has been connected to the vehicle, there may be a slight change in vehicle attitude which for your night driving safety may require the headlamps to be aimed.

Driver preparation

If you have never towed before, connect your trailer or caravan and take it for a run over familiar ground in your own district. Feel the difference in acceleration, handling and braking and you are less likely to be surprised if an emergency does occur, when you are away from home territory. The other driving members of your family should also become familiar with the vehicle in this condition.

Hill climbing

If particularly steep or long downgrades are encountered, avoid "riding" the brakes. Apply the brakes firmly to reduce speed and then remove your foot from the pedal to

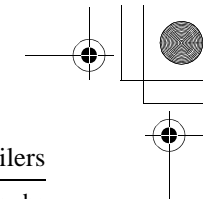
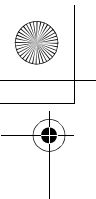

allow air to cool the brakes between applications.

Furthermore, it might be able to reduce the load of the brakes by using the regenerative brake force.

Normal cruising

Leave plenty of room between the front of your vehicle and the preceding vehicle.

If the caravan begins to sway or becomes difficult to handle, gently slow down or apply the independent trailer brakes (if fitted) NOT the vehicle brakes. Stop the vehicle and trailer in a safe location. Examine the tyres of the trailer closely for damage. If you find the damage of tyre, it is recommended that tyres be inspected by a MITSUBISHI MOTORS Authorised Service Point or a tyre retailer before proceeding further. Note that tread separation [separation of the tread band from the body of the tyre] of trailer tyres which are aged, and/or loaded near their load limit, can be difficult to detect, especially on caravans where tyres are covered.

One cause of swaying is poor trailer balance and until this has been overcome the swaying will recur. Relocate the load in your trailer or caravan and re-assess the problem.

If the wheels of your vehicle, the trailer or caravan leave the road surface and enter the

unsealed edge of the road, resist the urge to pull it back quickly. Wait for a section where the levels of the road and unsealed edge are comparable and then ease back onto the sealed section of the road with as little sway as possible.

Try to maximise the distance between your caravan and passing or overtaking semi-trailers or other heavy vehicles. This will reduce the suction forces between the two and minimise disturbance of the caravan.

Braking

Do not apply the brakes severely, be alert and anticipate trouble far enough ahead to enable you to apply the brakes smoothly and evenly.

Do not make any manoeuvres before ensuring that the road behind and in front of your vehicle is clear.

Overheating

This will normally occur as a result of some mechanical failure. If your vehicle should overheat, stop and check for a loose or broken water pump drive belt/ oil pump/cooling oil, a blocked radiator air intake or a low coolant level. If these items are satisfactory the overheating could be caused by a number of

Towing caravans and trailers

mechanical causes that would have to be checked at a MITSUBISHI MOTORS Authorised Service Point.

CAUTION

- If the engine overheats, reference should be made to “Engine overheating” section of “For emergencies” prior to taking any corrective action.

If your vehicle is in good mechanical condition and it overheats due to heavy traffic conditions or high air temperatures, additional cooling may be obtained by the following methods:

7

- Reduce your speed by 15 km/h if towing at high speeds.

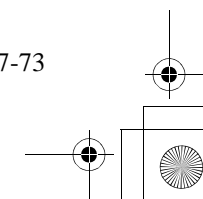
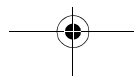
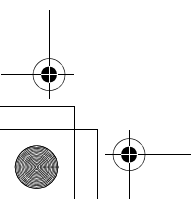
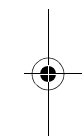
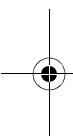

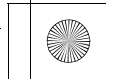
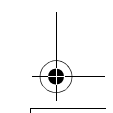
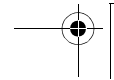
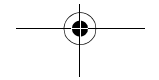
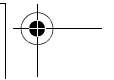
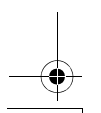
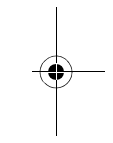
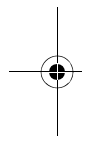
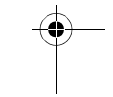
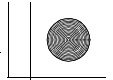
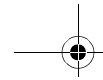
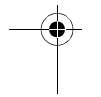
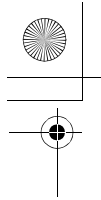

Handwriting practice area consisting of ten horizontal dashed lines.

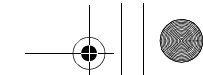

For pleasant driving

Ventilators	8-2	Ashtray	8-65
Automatic climate control air conditioner	8-4	Accessory socket	8-66
Important operation tips for the air conditioner	8-11	Interior lamps	8-66
Air purifier	8-12	Storage spaces	8-68
Remote Climate Control	8-12	Cup holder	8-70
Heating	8-12	Bottle holder	8-71
AM/FM radio/CD player *	8-12	Cargo area cover	8-71
Handling of Discs	8-15	Assist grips	8-72
Audio Files (MP3/WMA/AAC)	8-17	Coat hook	8-72
Important Points on Safety for the Customer	8-21	Luggage hooks	8-73
Operation Keys	8-22		
Listen to Radio	8-24		
Listen to CDs	8-26		
Listen to MP3s	8-26		
Listen to an iPod	8-28		
Listen to Audio Files on a USB Device	8-30		
Listen to Bluetooth Audio	8-32		
To listen to a disc in the rear-seat display (vehicles with rear-seat display)	8-34		
Display Indicator	8-34		
Audio Quality and Volume Balance Adjustment	8-35		
System Settings	8-36		
Troubleshooting	8-38		
Antenna	8-40		
Link System	8-40		
Bluetooth [®] 2.0 interface	8-41		
USB input terminal	8-61		
Sun visors	8-64		

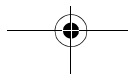
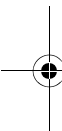

Ventilators

Ventilators

E00700100982

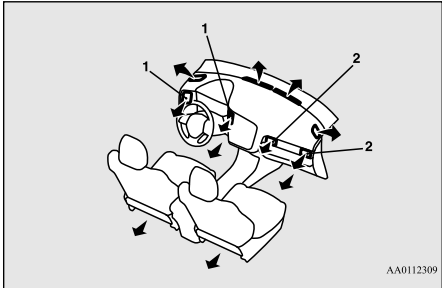

- 1- Driver's ventilators
- 2- Passenger's ventilators

8

NOTE

- Do not place beverages on top of the instrument panel. If they splash into the air conditioning ventilators, they could damage the system.

Air flow and direction adjustments

E00700200983

Driver's ventilators

Move the knob (A) to adjust the air flow direction.

8-2 For pleasant driving

To close the ventilator, fully move the knob (A) to the outer side.

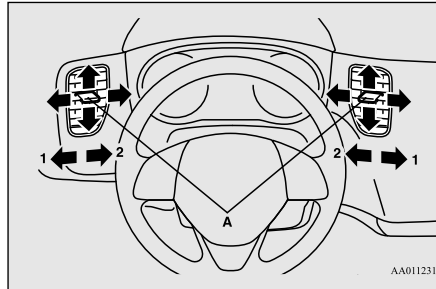

- 1- Close
- 2- Open

Passenger's ventilators

Move the knob (A) to adjust the air flow direction.

To close the ventilator, fully move the knob (A) to the left side.

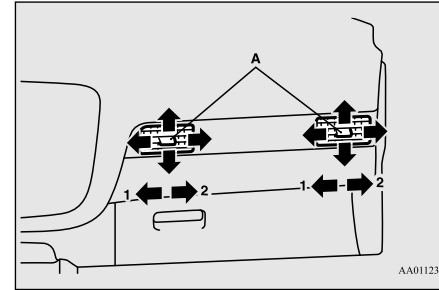

- 1- Close
- 2- Open

NOTE

- Be careful not to spill drinks, etc., into the ventilators. Doing so might cause the air conditioner not to function normally.

Mode selection

E00726501460

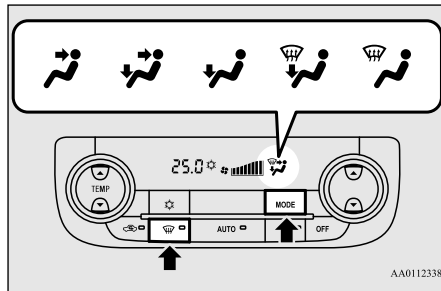

To change the amount of air flowing from the ventilators, press the MODE switch or demister switch. (Refer to "Mode switch" on page 8-9, "Demister switch" on page 8-9.)



 **Demister position**

Air flows mainly to the windscreen and the door windows.

 **NOTE**

- The foot/face air flow ratio can be adjusted with the mode selection in the “” position and the foot/demister air flow ratio can be adjusted with the mode selection in the “” position.

For further information, we recommend you to consult a MITSUBISHI MOTORS Authorised Service Point.

On vehicles equipped with Mitsubishi Multi-Communication System (MMCS), screen operations can be used to make the adjustment. Refer to the separate owner's manual for details.

 **Face position**

Air flows only to the upper part of the passenger compartment.

 **Foot/face position**

Air flows to the upper part of the passenger compartment, and flows to the leg area.

 **Foot position**

Air flows mainly to the leg area.

 **Foot/demister position**

Air flows to the leg area, the windscreen and the door windows.

Automatic climate control air conditioner

Automatic climate control air conditioner

E00702401436

Cooling or heating can only be performed when ready indicator is illuminating. When the operation mode is ON, only the blower is available.

NOTE

- If the drive battery level display indicates 0, the cooling performance cannot be obtained even the air conditioner is turned on. Refer to “Drive battery level display screen” on page 6-9.
- If the engine cannot be started due to fuel shortage, etc., the heating performance cannot be obtained even the air conditioner is turned on.

Control panel

8

E00702502476

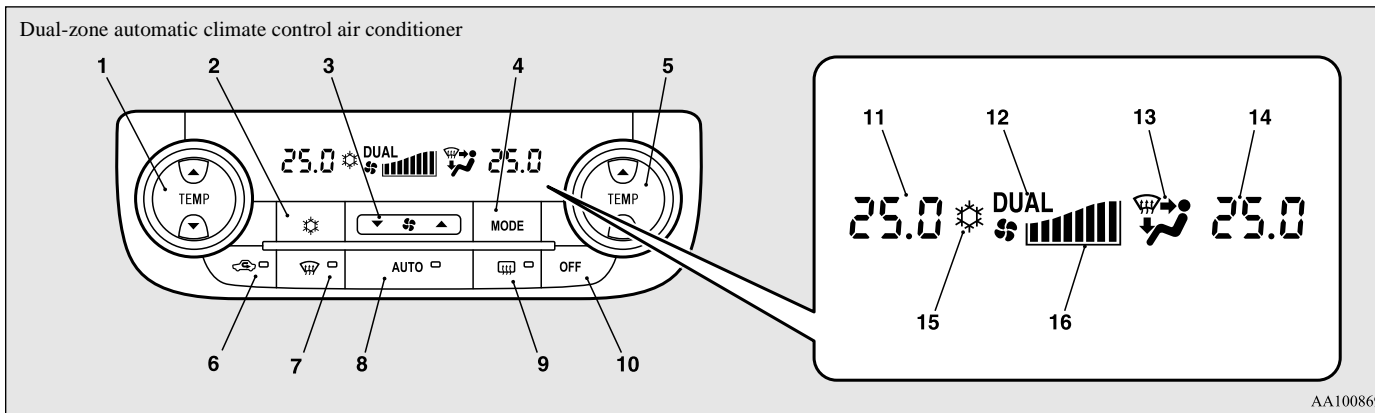

1- Passenger's side temperature control switch

3- Blower speed selection switch
4- MODE switch

5- Driver's side temperature control switch

2- Air conditioning switch

6- Air selection switch

8-4 For pleasant driving

- 7- Demister switch
- 8- AUTO switch
- 9- Rear window demister switch → P.6-53
- 10- OFF switch
- 11- Passenger's side temperature display → P.8-5
- 12- DUAL indicator
- 13- Mode selection display
- 14- Driver's side temperature display → P.8-5
- 15- Air conditioning indicator
- 16- Blower speed display

NOTE

- There is an interior air temperature sensor (A) in the illustrated position. Never place anything on top of the sensor, since doing so will prevent it from functioning properly.

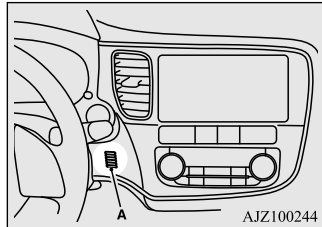

- Since the air conditioning operation is controlled while the ECO mode is operating, you may feel that effectiveness of the air conditioner is weak. → ECO mode switch P.6-46

NOTE

- Even if the ECO mode is operating, you can select normal operation of the air conditioner. On vehicles equipped with Mitsubishi Multi-Communication System (MMCS), screen operations can be used to change the setting. Refer to the separate owner's manual for details.
- In extreme cold, the air conditioning control panel screen may operate sluggishly. This does not indicate a problem. It will disappear when the vehicle interior temperature rises to a normal temperature.
- A sound will be made every time you push all the switches.

Blower speed selection switch

E00702801371

Press ▲ of the blower speed selection switch to increase the blower speed.
 Press ▼ of the blower speed selection switch to decrease the blower speed.
 The selected blower speed will be shown in the display (A).

Automatic climate control air conditioner

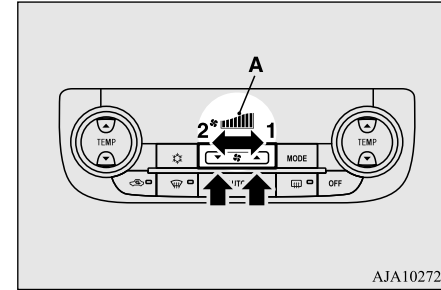

- 1- Increase
- 2- Decrease

8

Temperature control switch

E00703001673

Press ▲ or ▼ of the temperature control switch to the desired temperature.
 The selected temperature will be shown in the display (A).

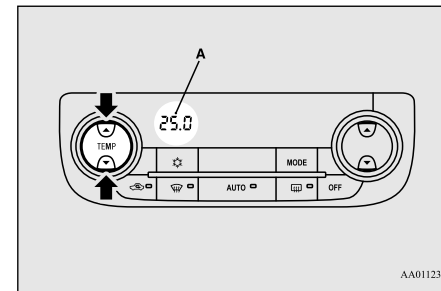

For pleasant driving 8-5

Automatic climate control air conditioner

NOTE

- The temperature value of air conditioner is switched in conjunction with outside temperature display unit of the multi information display.
Refer to “Changing the temperature unit” on page 6-17.
- While the engine coolant temperature is low, the temperature of the air from the heater will not change instantly, even if you have selected warm air with the switch.
To prevent the windscreen and windows from fogging up, the ventilator mode will be changed to “” and the blower speed will be reduced while the system is operating in the AUTO mode.
- When you feel that it is hot or cold to the setting temperature, it is possible to adjust so that you can feel more comfortable.
For further information, we recommend you to consult a MITSUBISHI MOTORS Authorised Service Point.
- When the temperature is set to the highest or the lowest, the air selection and the air conditioner will be automatically changed as follows.
Also, if the air selection is operated manually after an automatic changeover, manual operation will be selected.
- Quick Heating (When the temperature is set to the highest setting)
Outside air will be introduced and the air conditioner will stop.

8

NOTE

- Quick Cooling (When the temperature is set to the lowest setting)
Inside air will be recirculated and the air conditioner will operate.
- When the air conditioner is set to quick heating, the engine starts running (except vehicles with electric heater).

The settings described above are the factory settings.

The air selection and air conditioning switches can be customised (function setting changed), and the automatic switching of outside air and the air conditioner according to operating conditions can be changed as desired.

For further information, we recommend you to consult a MITSUBISHI MOTORS Authorised Service Point.

Refer to “Customising the air conditioning switch” on page 8-8.

Refer to “Customising the air selection” on page 8-7.

■ Synchronized mode and dual mode

The driver’s side and the passenger’s side temperature can be controlled independently. At this time, the “DUAL” indicator will be shown in the display (A).

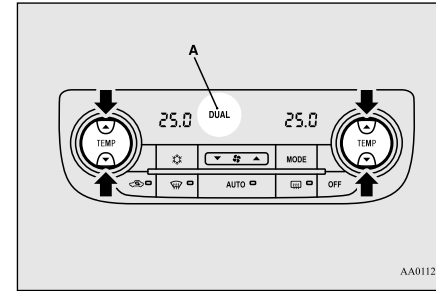

● Synchronized mode

If the driver’s side temperature control switch is pressed, the passenger’s side temperature will also be controlled to the same setting temperature as the driver’s side.

● Dual mode

If the passenger’s side temperature control switch is pressed under synchronized mode, the system will switch to dual mode. In dual mode, the driver’s side and the passenger’s side temperature can be set separately by using each temperature control switch.

Press the AUTO switch to return to synchronized mode.

Air selection switch

E00703401808

To change the air selection, simply press the air selection switch.

- Outside air: Indicator lamp (A) is OFF
Outside air is introduced into the passenger compartment.
- Recirculated air: Indicator lamp (A) is ON
Air is recirculated inside the passenger compartment.

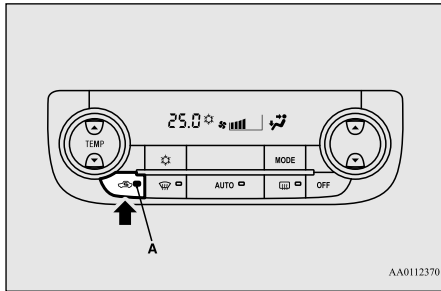

CAUTION

- Use of the recirculation position for an extended time may cause the windows to fog up.

NOTE

- Normally, use the outside position to keep the windscreen and side windows clear and quickly remove fog or frost from the windscreen.
If high cooling performance is desired, or if the outside air is dusty or otherwise contaminated use the recirculation position. Switch to the outside position periodically to increase ventilation so that the windows do not become fogged up.
- When the engine coolant temperature rises to a certain level, the air selection is automatically switched to the recirculation position and the indicator lamp (A) comes on. At this time, the system will not switch to the outside position even if the air selection switch is pushed.
- When the outside air temperature is high, the system will not switch to the outside position even the air selection switch is pushed if the air conditioner is operating. This is to protect the air conditioner compressor and is not a failure.

■ Customising the air selection

E00739600022

Functions can be changed as desired, as stated below.

Automatic climate control air conditioner

- Enable automatic air control
When the AUTO switch is pressed, the air selection switch is also controlled automatically.
- Disable automatic air control
Even when the AUTO switch is pressed, the air selection switch is not controlled automatically.
- Setting change method
Hold down the air selection switch for about 10 seconds or more.
 - When the setting is changed from enable to disable
3 sounds are emitted and the indicator lamp flashes 3 times.
 - When the setting is changed from disable to enable
2 sounds are emitted and the indicator lamp flashes 3 times.

8

On vehicles equipped with Mitsubishi Multi-Communication System (MMCS), screen operations can also be used to change the setting. Refer to the separate owner's manual for details.

NOTE

- The factory setting is "Enable automatic air control".

Automatic climate control air conditioner

NOTE

- When the demister switch is pressed, in order to prevent misting of the windows the ventilator automatically switches to outside air even if “Disable automatic air control” is set.

AUTO switch

E00702600037

When the AUTO switch is pressed, the indicator lamp (A) comes on and the mode selection (except for “”), blower speed adjustment, recirculated/outside air selection, temperature adjustment, and air conditioner ON/OFF status are all controlled automatically.

8

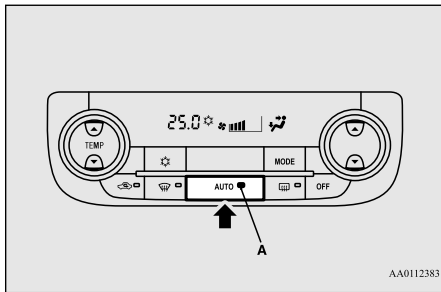

Air conditioning switch

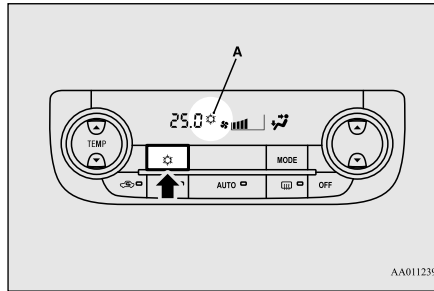

E00703502327

Push the switch to turn the air conditioner on, the “” indicator will be shown in the display (A).



Push the switch again to switch it off.



NOTE

- If a problem is detected in the air conditioning system, the “” indicator blinks. Press the air conditioning switch once to turn it off, then once more to turn it back on. If the “” indicator does not blink for a while, there is nothing wrong. If it starts to blink again, we recommend you to have it checked.

■ Customising the air conditioning switch

E00739700023

Functions can be changed as desired, as stated below.

- Enable automatic air conditioning control
When the AUTO switch is pressed, or the temperature control switch is set to the minimum temperature, the air conditioning switch is controlled automatically.
- Disable automatic air conditioning control
The air conditioning switch is not controlled automatically as long as the air conditioning switch is not operated.
- Setting change method
Hold down the air conditioning switch for about 10 seconds or more.
 - When the setting is changed from enable to disable
3 sounds are emitted and the “” indicator flashes 3 times.
 - When the setting is changed from disable to enable
2 sounds are emitted and the “” indicator flashes 3 times.

On vehicles equipped with Mitsubishi Multi-Communication System (MMCS), screen operations can also be used to change the setting. Refer to the separate owner's manual for details.

NOTE

- The factory setting is "Enable automatic air conditioning control".
- When the demister switch is pressed, in order to prevent misting of the windows the air conditioner operates automatically even if "Disable automatic air conditioning control" is set.

OFF switch

E00702700038

Push the switch to turn off the air conditioning system.

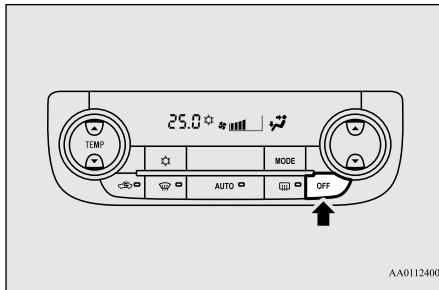

MODE switch

E00703300031

Each time the MODE switch is pressed, the mode changes to the next one in the following sequence: "OFF" → "FRESH AIR" → "AUTO" → "MODE" → "FRESH AIR" → "OFF". The selected mode is shown in the display (A). (Refer to "Mode selection" on page 8-2.)

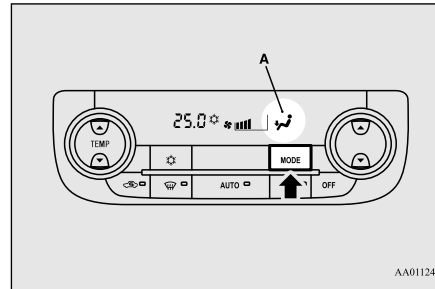

Demister switch

E00703901063

When this switch is pressed, the mode changes to the "FRESH AIR" mode. The indicator lamp (A) will come on. The selected mode is shown in the display (B). (Refer to "Mode selection" on page 8-2.)

Automatic climate control air conditioner

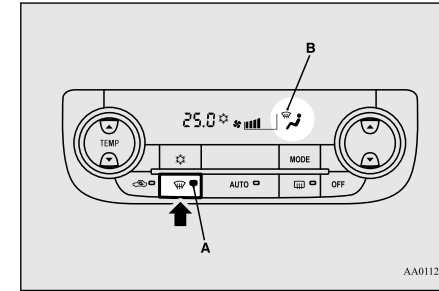

NOTE

- When the demister switch is pressed, the air conditioning system automatically operates and outside air (as opposed to recirculated air) is selected. This automatic switching control is carried out to prevent misting of the windows even if "Disable automatic air conditioning control" or "Disable automatic air control" is set. (Refer to "Customising the air conditioning switch" on page 8-8, "Customising the air selection" on page 8-7.)
- When the demister switch is pressed, the engine may start running (except vehicles with electric heater).

8

Automatic climate control air conditioner

Operating the system in automatic mode

E00704102131

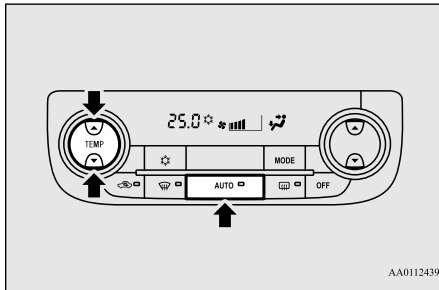

8

In normal conditions, use the system in the AUTO mode and follow these procedures:

1. Push the AUTO switch.
2. Set the temperature control switch to the desired temperature.

The mode selection (except for “”), blower speed adjustment, recirculated/outside air selection, temperature adjustment, and air conditioner ON/OFF status are all controlled automatically.

NOTE

- If the blower speed selection switch, air conditioning switch, Mode switch, or air selection switch is operated while the system is operating in the AUTO mode, the activated function overrides the corresponding function of automatic control. All other functions remain under automatic control.

Operating the system in manual mode

E00704200239

Blower speed and ventilator mode may be controlled manually by setting the blower speed selection switch and the MODE switch to the desired positions.
To return to automatic operation, press the AUTO switch.

Demisting of the windscreen and door windows

E00704301947

CAUTION

- For safety, make sure you have a clear view through all the windows.

For ordinary demisting

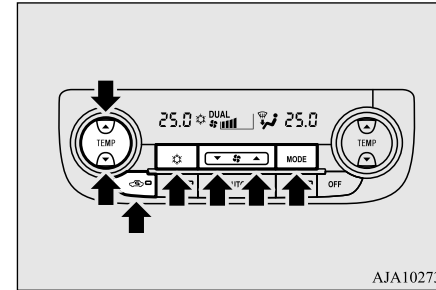

AJA102735

1. Set the air selection switch to the outside position.
2. Set the MODE switch to the “” position.
3. Select your desired blower speed by pressing the blower speed selection switch.
4. Select your desired temperature by pressing the temperature control switch.
5. Push the air conditioning switch.

■ For quick demisting

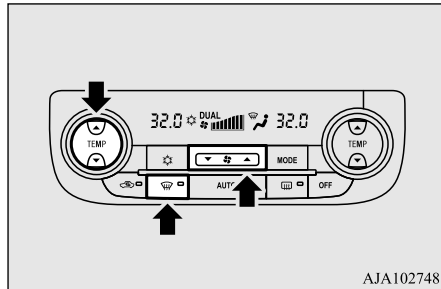

AJA102748

1. Push the demister switch to change to the “” position.
2. Set the blower to the maximum speed.
3. Set the temperature to the highest position.

NOTE

- To demist effectively, direct the air flow from the side ventilators towards the door windows.
- Do not set the temperature to the max. cool position. Cool air will blow against the window glasses and prevent demisting.

Driving in dusty conditions

E00704400127

When driving on a dirt road, adjust the ventilation controls as follows:

1. Set the air selection switch to the outside position.
2. Select the MODE switch to the desired position.
3. Select the temperature control switch to the desired position.
4. Select the desired blower speed (the higher the better).
5. Ensure all windows are closed (to pressurise the cabin).

If you are driving behind another vehicle on a dirt road and/or the outside air is dusty or contaminated, set the air selection switch to the recirculation position. During periods of extended driving, ventilate the vehicle's interior by occasionally setting the switch from the recirculation to the outside position.

Important operation tips for the air conditioner

E00708302102

- Park the vehicle in the shade.
Parking in the hot sun will make the vehicle inside extremely hot, and it will require more time to cool the interior. If it is necessary to park in the sun, open the windows for the first few minutes of air conditioning operation to expel the hot air.

Important operation tips for the air conditioner

- Close the windows when the air conditioner is in use. The entry of outside air through open windows will reduce the cooling efficiency.
- Too much cooling is not good for the health. The inside air temperature should only be 5 to 6 °C below the outside air temperature.
- When operating the system, make sure the air intake, which is located in front of the windscreen, is free of obstructions such as leaves and snow. Leaves collected in the air-intake plenum may reduce air flow and plug the plenum water drains.
- Too much cooling/heating can affect the EV cruising range, so maintain an appropriate temperature to extend the EV cruising range.

8

Air conditioning system refrigerant and lubricant recommendations

If the air conditioner seems less effective than usual, the cause might be a refrigerant leak. We recommend you to have the system inspected.

The air conditioning system in your vehicle must be charged with the refrigerant HFC-134a and the lubricant POE MA68EV.



Air purifier

Use of any other refrigerant or lubricant will cause severe damage which will result in the need to replace your vehicle's entire air conditioning system. New regulations in support of the Australian Government's Ozone Protection and Synthetic Greenhouse Gas Management Act 1989 became effective in January 2005. To ensure your vehicle servicing and repairs conform with requirements, the air conditioning system should be inspected and maintained by a MITSUBISHI MOTORS Authorised Service Point.

8

During a long period of disuse

The air conditioner should be operated for at least five minutes each week, even in cold weather. This is to prevent poor lubrication of the compressor internal parts and to maintain the air conditioner in the best operating condition.

Air purifier

E00708400718

An air filter has been incorporated into this air conditioner so that dirt and dust are cleaned from the air.

Replace the air filter periodically as its ability to clean the air will be reduced as it collects pollen and dirt. For the maintenance interval, refer to the "SERVICE BOOKLET".

8-12 For pleasant driving



NOTE

- Operation in certain conditions such as driving on a dusty road and frequent use of the air conditioner can lead to reduction of service life of the filter. When you feel that the airflow is lower than normal or when the windscreen or windows start to fog up easily, replace the air filter.
We recommend you to have it checked.

Remote Climate Control

E00735401045

You can run the air conditioner in advance of using the vehicle.

For details, refer to "Remote Climate Control" on page 3-17.

Heating

E00733901059

When heating, the engine starts running because the heating system uses the heat of engine coolant.

On vehicles with electric heater, it can decrease the number of times engine starting because electrical power stored in the drive battery is also used when heating.

AM/FM radio/CD player*

E00708503390

The audio system can only be used when the operation mode of the power switch is in ON or ACC.

NOTE

- To listen to the audio system while the Plug-in Hybrid EV system is not operating, put the operation mode of the power switch in ACC. If the operation mode of the power switch is left in ACC, the accessory power will automatically turn off after a certain period of time and you will no longer be able to use the audio system. The accessory power comes on again if the operation mode of the power switch is operated with is in the ACC. Refer to "ACC power auto-cutout function" on page 7-11.
- If a cellular phone is used inside the vehicle, it may create noise from the audio equipment. This does not mean that anything is wrong with your audio equipment. In such a case, use the cellular phone at a place as far away as possible from the audio equipment.
- If foreign objects or water get into the audio equipment, or if smoke or a strange odour comes from it, immediately turn off the audio system. We recommend you to have it checked. Never try to repair it by yourself. Avoid continuous usage without inspection by a qualified person.

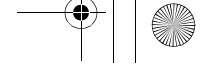
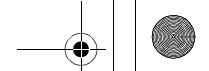

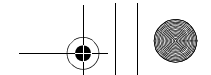

Important Points on Usage

E00735500023

iPod/iPhone Playback Function*

- This product supports audio playback from iPod/iPhone devices, however differing versions mean that playback cannot be guaranteed.
- Please be aware that depending on the iPod/iPhone model or version, operation may differ.

How to Clean

E00735700025

- If the product becomes dirty, wipe with a soft cloth.
- If very dirty, use a soft cloth dipped in neutral detergent diluted in water, and then wrung out. Do not use benzene, thinners, or other chemical wipes. This may harm the surface.

Trademarks

E00735801049

- Product names and other proper names are the trademarks or registered trademarks of their respective owners.

- Furthermore, even if there is no specific denotation of trademarks or registered trademarks, these are to be observed in their entirety.













“Made for iPod”, “Made for iPhone” mean that an electronic accessory has been designed to connect specifically to iPod or iPhone, respectively, and has been certified by the developer to meet Apple performance standards. iPhone, iPod, iPod classic, iPod nano, and iPod touch are trademarks of Apple Inc., registered in the U.S. and other countries. Apple is not responsible for the operation of this device or its compliance with safety and regulatory standards.

NOTE

- iPod and iTunes licensing allows individual users to privately reproduce and play back non-copyrighted material as well as material that may be legally copied and reproduced. Infringement of copyright is prohibited.
- Supported models for equipment by type will vary. For details, see the Johnson Controls, Inc. website.

AM/FM radio/CD player*

iPod		iPod classic		
				
iPod 5th generation (video) 60GB 80GB	iPod 5th generation (video) 30GB	iPod classic 160GB (2009)	iPod classic 160GB (2007)	iPod classic 80GB

iPod nano		
		
iPod nano 6th generation 8GB 16GB	iPod nano 5th generation (video camera) 8GB 16GB	iPod nano 4th generation (video) 8GB 16GB
		
iPod nano 3rd generation (video) 4GB 8GB	iPod nano 2nd generation (aluminum) 2GB 4GB 8GB	iPod nano 1st generation 1GB 2GB 4GB

AA5013326

8

Handling of Discs

iPod touch



iPod touch
4th generation
8GB 32GB 64GB



iPod touch
3rd generation
32GB 64GB



iPod touch
2nd generation
8GB 32GB 64GB

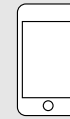

iPod touch
1st generation
8GB 32GB 64GB

iPhone



iPhone 4S
16GB 32GB 64GB



iPhone 4
16GB 32GB



iPhone 3GS
8GB 16GB 32GB



iPhone 3G
8GB 16GB

8

AJ5100128

Handling of Discs

E00735901040

This explains care that should be taken in the handling of discs.

For pleasant driving 8-15

Handling of Discs

Important Points on Handling

- Fingerprints or other marks on the read surface of the disc may result in its content being more difficult to read. When holding the disc, grip both edges, or one edge and the centre hole, in order that the read surface is not touched.
- Do not affix paper or stickers, or otherwise damage the disc.
- Do not forcefully insert a disc if another is already within the device. This can result in damage to discs, or malfunction.

8

Cleaning

- Periodically clean the read surface of the disc. When cleaning, do not wipe in a circular motion. Instead, wipe gently outwards from the centre of the disc to the outer edge.
- New discs may have burring around the outer edge or in the hole in the centre. Ensure you check for these. If there are burrs, these may lead to faulty operation, therefore ensure these are removed.

Important Points on Storage

- When not using discs, ensure these are kept in cases, and stored out of direct sunlight.

8-16 For pleasant driving

- If discs are not going to be used for a long period of time, remove these from the product.

Disc Playback Environment

In cold environments such as in mid-winter when the interior of the vehicle is cold, turning the heater on and immediately trying to use the product may cause condensation (water droplets) to form on the disc and internal optical components, and this may prevent the product from operating correctly. In these conditions, remove the disc, and wait a short time before use.





Copyright

Actions such as unauthorised reproduction, broadcast, public performance, or rental of discs that comprise other than personal use are prohibited by law.

Types of Disc That Can Be Played Back

E00736001035

The following marks are printed on the disc label, package, or jacket.

Type	Size	Maximum playback time	Comments
CD-DA 	12 cm	74 minutes	—
CD-TEXT 	12 cm	74 minutes	—
CD-R/RW  	12 cm	—	•Disc containing MP3 files

Discs That May Not Be Played Back

- Playback of discs other than those described in “Types of Disc That Can Be Played Back” is not guaranteed.
- 8 cm discs may not be used.
- Do not insert irregularly-shaped discs (for example, heart-shaped), as these may result in malfunction. Additionally, discs that have transparent portions may not be played back.

Audio Files (MP3/WMA/AAC)

- Discs that have not been finalized cannot be played back.
 - Even if recorded using the correct format on a recorder or computer, application software settings and environments; disc peculiarities, damage, or marking; or dirt or condensation on the lens inside the product may render the disc unplayable.
 - Depending on the disc, some functions may not be used, or the disc may not play back.
 - Do not use discs with cracks or warps.
 - If the disc has stickers affixed, remains from removed stickers, or affixed adhesive, then do not use the disc.
 - Discs that have decorative labels or stickers may not be used.
- There may be noise during playback.
 - There may be jumping in the audio.
 - The disc may not be recognized.
 - The first track may not be played back.
 - It may take longer than usual until start of playback of tracks.
 - Playback may start from within the track.
 - Some parts may not be played back.
 - Tracks may freeze during playback.
 - Tracks may be displayed erroneously.

Audio Files (MP3/WMA/AAC)

E00736100026

This product can play back MP3/WMA/AAC format audio files recorded on CD-ROM, CD-R/RW, and USB devices.

There are limitations on the files and media that can be used, therefore read the following prior to recording MP3/WMA/AAC format audio files on discs or USB devices.

Additionally, ensure you read the user manuals for your CD-R/RW drive and the writing software, and ensure these are used correctly. If the MP3/WMA/AAC format audio files includes title information or other data, then this can be displayed.

Nonstandard CDs

This product will play back audio CDs, however please be aware of the following points regarding CD standards.

- Ensure that you use discs with **disc** on the label surface.
- Playback of other than standard CDs is not guaranteed. Even if the audio can be played back, the audio quality cannot be guaranteed.
- When playing back other than standard CDs, the following may occur.

CAUTION

- CD-ROM and CD-R/RW media can only play back MP3 format audio files.
- Actions such as copying audio CDs or files and either distributing these to others for free or for charge, or uploading files via the Internet or other means to servers is an infringement of the law.
- Do not append the file extensions “.mp3”, “.wma”, or “.m4a”, to other than MP3/WMA/AAC format files. Playing back discs with these types of files recorded upon them may cause the files to be incorrectly identified for playback, which may lead to loud noise, resulting in speaker damage or accident.

NOTE

- Depending on the condition of the disc recorder or recording software used, correct playback may not be possible. In these cases, refer to the user manual for your product or software.
- Depending on your computer's operating system, version, software, or settings, files may not have a file extension appended. In these cases, append the file extensions “.mp3”, “.wma”, or “.m4a” when copying the files.
- Files larger than 2GB in size cannot be played back.

Audio Files (MP3/WMA/AAC)

Data Formats That Can Be Played Back

E00736200030

Data formats that can be played on discs (CD-ROM, CD-R/RW) and USB devices differ.

Data format	DISC	USB device
MP3	○	○
WMA	X	○
AAC	X	○

8

Folder Structure

E00736300031

Up to 8 folder levels can be recognized.
You can create a folder structure as in Genre - Artist - Album - Track (MP3/WMA/AAC format audio files) for management of tracks.

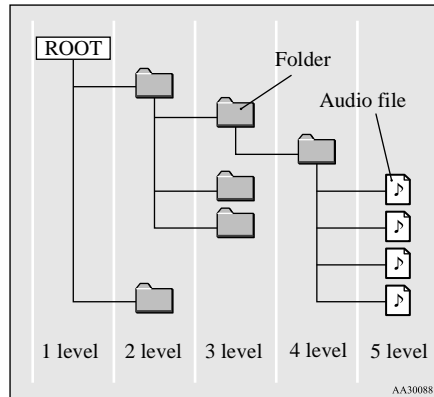

Name	Specification	Explanation	
Format specifications	ISO9660	Level 1	Maximum 8 character file name, and 3 character file extension. (single-byte alphanumeric capital letters, numerals, “_” may be used)
	ISO9660 extension	Joliet	Files names up to a maximum 64 characters can be used.
Multisession	Not supported (only first session supported)		
Maximum number of levels	8 levels (if the root is the 1st level)		
Maximum folder number	700 folders (including root)		
Maximum file number*1	65,535 files (total number on media. Other than MP3, WMA, and AAC files not included)		

Audio Files (MP3/WMA/AAC)

Name	Specification	Explanation
File name and folder name restrictions	Maximum 64 bytes (for Unicode, 32 characters), files/ folders with file/ folder names longer than this will not be displayed or played back.	
USB supported formats	The recommended file system is FAT32. 1 partition only	

*1. Do not include other than MP3/WMA/AAC files. However, if storing many tracks within the same folder, these may not be recognized even if less than the maximum number of tracks. In these cases, divide the tracks up into multiple folders.

NOTE

- The order in which folders and audio files are displayed on this product may be different to how they are displayed on a computer.

What Is MP3?

E00736400029

MP3 is an abbreviation of “MPEG-1 Audio Layer 3”. MPEG is an abbreviation of

“Motion Picture Experts Group”, and this is a video compression standard used in video CDs, etc.

MP3 is one of the audio compression methods contained in the MPEG audio standard, and reduces the quality of sounds that are beyond the auditory resolution of the human ear and that are hidden by louder sounds, thus creating high-quality data with a lower data size.

Because this can compress CD audio to approximately 1/10 its original data size without perceptible loss, approximately 10 CDs can be written to a single CD-R/RW disc.

CAUTION

- MP3 files different to the standards at right may not play back correctly, or file/folder names may not be displayed correctly.

Standards for MP3 Files That Can Be Played Back

Specifications for MP3 files that can be played are as below.

Item	Details
Specification	MPEG-1 AUDIO LAYER3
	MPEG-2 AUDIO LAYER3

Item	Details
Sampling frequency [kHz]	MPEG-1: 32/44.1/48
	MPEG-2: 16/22.05/24
Bit rate [kbps]	MPEG-1: 32 to 320
	MPEG-2: 8 to 160
VBR (variable bit rate)	Support
Channel mode	Stereo/ Joint stereo/ Dual channel/ Monaural
File extension	mp3
Supported tag information	ID3 tag Ver. 1.0, Ver. 1.1, Ver. 2.2, Ver. 2.3, Ver. 2.4 (ISO-8859-1, UTF-16 (Unicode)), Titles, Artist name, Album name
Maximum number of characters that can be indicated on the display	64 characters

8

What Is WMA?

E00736601031

WMA is an abbreviation of Windows Media Audio, and this is an audio compression format from Microsoft. This is a compression

For pleasant driving 8-19

Audio Files (MP3/WMA/AAC)

format that has a higher compression ratio than MP3.

NOTE

- Microsoft, Windows Media, and Windows are registered trademarks of Microsoft Corporation (USA) and in other countries.

CAUTION

- WMA supports digital rights management (DRM). This product cannot play back WMA files protected using this system.
- WMA files different to the standards at right may not play back correctly, or file/folder names may not be displayed correctly.
- “Pro”, “Lossless”, and “Voice” are not supported.

8

Standards for WMA Files That Can Be Played Back

Specifications for WMA files that can be played are as below.

Item	Details
Specification	Windows Media Audio Version7.0/8.0/9.0
Sampling frequency [kHz]	32/44.1/48

8-20 For pleasant driving

Item	Details
Bit rate [kbps]	48 to 320
VBR (variable bit rate)	Support
Channel mode	Stereo/Monaural
File extension	wma
Supported tag information	WMA tags Title name, Artist name, Album name
Maximum number of characters that can be indicated on the display	64 characters

What Is AAC?

E00736801033

AAC is an abbreviation of Advanced Audio Coding, and this is an audio compression standard used in “MPEG-2” and “MPEG-4”. This features 1.4x the compression of MP3, with comparable audio quality.

CAUTION

- AAC supports digital rights management (DRM). This product cannot play back AAC files protected using this system.

CAUTION

- AAC files different to the standards at right may not play back correctly, or file/folder names may not be displayed correctly.

Standards for AAC Files That Can Be Played Back

Specifications for AAC files that can be played are as below.

Item	Details	
Specification	Advanced Audio Coding MPEG4/AAC-LC MPEG2/AAC-LC	
Sampling frequency [kHz]	MPEG4	8/11.025/12/16/22.05/24/32/44.1/48
	MPEG2	8/11.025/12/16/22.05/24/32/44.1/48
Bit rate [kbps]	MPEG4	8 to 320
	MPEG2	8 to 320
VBR (variable bit rate)	Support	
Channel mode	Stereo/Monaural	
File extension	m4a	

Important Points on Safety for the Customer

Item	Details
Supported tag information	AAC tags or ID3 tags Title, Artist name, Album name
Maximum number of characters that can be indicated on the display	64 characters

Important Points on Safety for the Customer

E00737000035

This product features a number of pictorial indications as well as points concerning handling so that you can use the product correctly and in a safe manner, as well as prevent injury or damage to yourself, other users, or property.

WARNING

- The driver should not pay close attention to the display while driving. This may prevent the driver looking where they are going, and cause an accident.

WARNING

- The driver should not perform complicated operations while driving. Performing complicated operations while driving may prevent the driver looking where they are going, and cause an accident. Therefore stop the vehicle in a safe location before performing such operations.
- Do not use during malfunctions, such as when no sound is audible. This may lead to accident, fire, or electric shock.
- Ensure water or other foreign objects do not enter the product. This may lead to smoking, fire, electric shock, or malfunction.
- Do not insert foreign objects into the disc slot. This may lead to fire, electric shock, or malfunction.
- In the event of abnormalities occurring when foreign objects or water enter the product, resulting in smoke or a strange smell, immediately stop using the product, and consult a MITSUBISHI MOTORS Authorised Service Point. Continuing to use the product may result in accident, fire, or electric shock.
- Do not disassemble or modify the product. This may lead to malfunction, fire, or electric shock.

WARNING

- During thunderstorms, do not touch the antenna or the front panel. This may lead to electrical shock from lightning.

CAUTION

- Do not block ventilation holes or heat sinks on the product. Blocking ventilation holes or heat sinks may prevent heat from escaping from within the product, leading to fire or malfunction.
- Do not turn the volume up to the extent that you cannot hear sounds from outside the vehicle while driving. Driving without being able to hear sounds from outside the vehicle may result in an accident.
- Do not insert your hand or fingers into the disc slot. This may result in injury.

Operation Keys

Operation Keys

E00737100023

Turn the Power ON/ OFF

E00737200024

1. Press the PWR/VOL key.

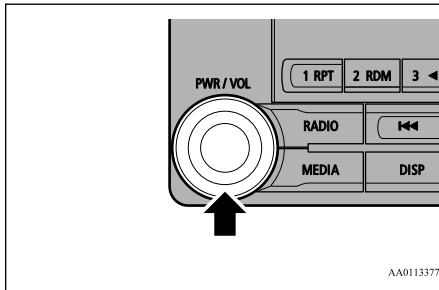

8

Turn the power on, and resume playback from the previous status.

2. Press the PWR/VOL key.
Turn the power OFF.

NOTE

- Hold down the steering MODE key to also turn the audio function ON/OFF.

Adjust Volume

E00737300025

1. Turn the PWR/VOL key to adjust the volume.

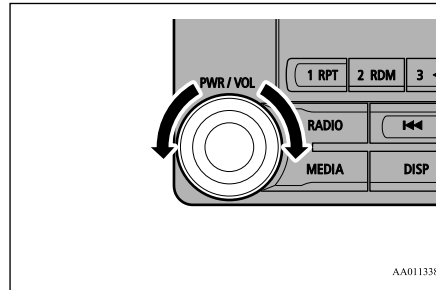

Turn the PWR/VOL key clockwise to increase, and counter-clockwise to decrease the volume.

NOTE

- The maximum value for volume is 45, and the minimum is 0.
- The initial setting for volume is "17".

Insert/Eject Discs

E00737400026

1. Insert the disc into the disc slot with the label surface up.

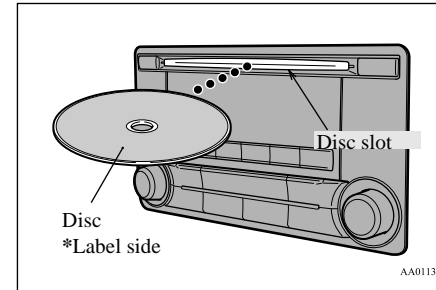

Push the disc in a certain amount, and the product will pull the disc in, and playback will start.

2. Press the ▲ key.
This will eject the disc from the product, so remove the disc.

CAUTION

- When replacing discs, first ensure that the vehicle is stopped in an area in which stopping is permitted.
- Do not insert your hand, fingers, or foreign objects into the disc slot. This may lead to injury, smoking, or fire.
- 8 cm CDs are not supported.

Explanation of Buttons

E00737501079

This explains names and functions of each part.

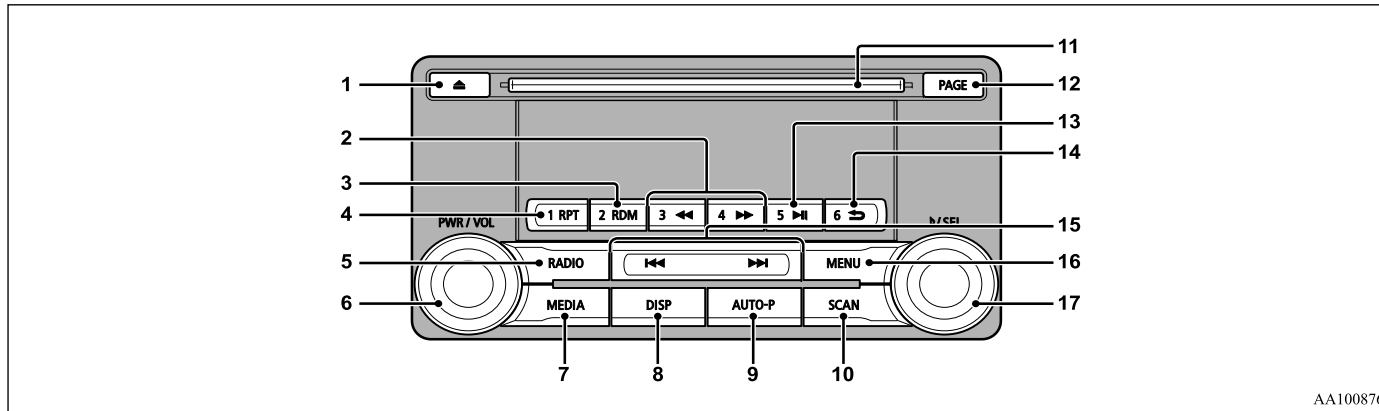

AA1008766

8

- | | | |
|---|---|--|
| <p>1- ▲ key
Use to eject a disc.</p> <p>2- 3◀◀ key/4▶▶ key
For audio, rewind/fast forward.
For radio, use as preset keys 3 and 4.</p> <p>3- 2RDM key
For audio, play random playback; for radio, use as preset key 2.</p> <p>4- 1RPT key
For audio, play repeat playback; for radio, use as preset key 1.</p> | <p>5- RADIO key
Switch the radio and the band.</p> <p>6- PWR/VOL key
Adjust the volume, and turn the power ON/OFF.</p> <p>7- MEDIA key
Switch between CD and other sources.
Hold down the key to switch to AUX.</p> <p>8- DISP key
Switch the content of the display.</p> <p>9- AUTO-P key
Auto preset the radio.</p> | <p>10- SCAN key
For audio, play scan playback; for radio, scan for stations.</p> <p>11- Disc slot</p> <p>12- PAGE key
Display indicator page advance.</p> <p>13- 5 ▶ key
Play/Pause Bluetooth Audio*, and use as preset key 5 for radio.</p> |
|---|---|--|

Listen to Radio

- 14- 6 ➡ key
Return during audio track search, and stop Bluetooth Audio*.
For radio, use as preset key 6.
 - 1-◀◀ key/▶▶▶ key
 - 15- For audio, select audio track/file; for radio, perform automatic station selection.
 - 16- MENU key
Switch to Menu mode.
 - 17- ▶/SEL key
Adjust audio quality and select items.
For radio, manually select stations.
- *: Requires a separately-purchased Bluetooth-capable audio device in equipment by type.

8

Steering wheel audio remote control switches

E00737601155

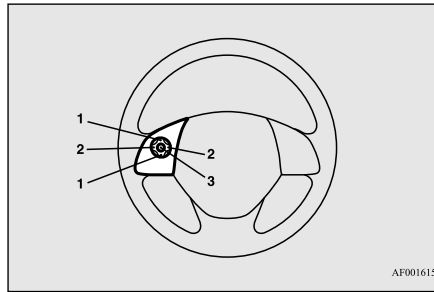

AF0016154

- 1- Vol + key, - key
Adjust audio functions and the mobile phone function volume.
- 2- CH ▼ key, ▲ key
Select CD and other audio source tracks and radio stations.
Hold down to skip up and down through tracks.
- 3- MODE key
Hold down to turn the audio function ON/OFF. Additionally, each time this is pressed, this switches the audio source. The order of switching is as shown below.
If devices are not connected, then these are to be skipped, and the next source selected.

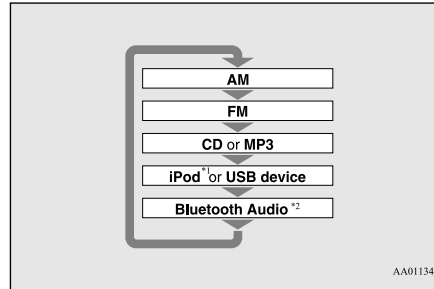

AA0113407

- *1: An iPod cable (available separately) is required.
- *2: Requires a separately-purchased Bluetooth-capable audio device.

Listen to Radio

E00737700029

This explains how to listen to AM and FM radio broadcasts.

To Listen to the Radio

Press the RADIO key to switch the band.

Switch between AM and FM bands.
The selected band is indicated on the display.

NOTE

- This switches between AM and FM.

Manual/Seek Station Selection

Turn the **▶/SEL** key to the frequency to listen to.

▶/SEL key (counter-clockwise)	Reduces the frequency being received.
▶/SEL key (clockwise)	Increases the frequency being received.
▶▶ key (hold down)	Release the button to start seek station selection, and when a station is received, scanning stops.
◀◀ key (hold down)	

Scan Station Selection

Collective search for stations that can be received.

Press the **SCAN** key.

When a station is received, this is played for 5 seconds, then the product searches for the next station.

NOTE

- Press this button again while receiving the station to return to normal reception.

Preset Memory

Register the broadcast station in advance, and select this at a later time.

1. Tune in to the frequency to register.
2. Hold down any of the keys from the **IRPT** key to the **6** key.

A “Beep” sounds, and the preset key is registered.

NOTE

- The preset memory can register a maximum of 6 stations for each band.
- If a preset key that already has a station registered is selected, then this is overwritten with the new preset.
- Pressing the preset key will select the previously registered frequency.

Auto Preset

The top 6 stations with a strong signal can be automatically registered in order with preset keys in the **AUTO-P** mode.

Hold down the **AUTO-P** key.

Switch to the **AUTO-P** mode, and start automatic station selection. After completion of operations, the product will receive the station registered in the preset key [1].

CAUTION

- Please be aware that the formerly-registered frequency in the memory will be overwritten.

NOTE

- Separate to normal reception preset keys, this registers in preset keys in the **AUTO-P** mode.
- Pressing the preset key will select the previously registered frequency.
- Each time the **AUTO-P** key is pressed, this switches between normal reception and **AUTO-P** mode.
- In the **AUTO-P** mode, manual/seek station selection, as well as scan operation is also possible.

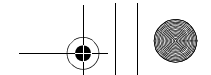

Listen to CDs

Listen to CDs

E00737800033

This explains how to listen to audio CDs (CD-DA/CD-TEXT).

Play CDs

Insert the disc.

Insert a disc to automatically start playback.
→ “Insert/Eject Discs” (P.8-22)

8

If a disc is already within the product, press the MEDIA key to switch to CD as the source.

Select the Track

Press the **1◀◀** key or **▶▶1** key to select the track.

This enables selection of the next or previous track.

Fast Forward or Rewind

Hold down the **3◀◀** key or the **4▶▶** key.

Fast forward/rewind is possible.

Switch Playback Mode

Repeat playback, random playback, and scan playback are possible.

Repeat Playback (RPT)

Press the 1RPT key.

Repeat playback of the track currently being played.

NOTE

- Pressing again will cancel.
- Selecting a track, ejecting, fast forwarding, or rewinding will cancel.

Random Playback (RDM)

Press the 2RDM key.

Play the tracks on the disc in a random order.

NOTE

- Pressing again will cancel.
- Ejecting will cancel this.

Scan Playback (SCAN)

Press the SCAN key.

Play the first 10 seconds of each of the tracks on the whole disc in order.

NOTE

- Press this button again during playback if you wish to hear that track, and that track will play normally.

Listen to MP3s

E00737900034

This explains how to listen to audio files on a disc.

CAUTION

- CD-ROM and CD-R/RW media can only play back MP3 format audio files.

To Listen to MP3s

Insert the disc.

Insert a disc to automatically start playback.
→ “Insert/Eject Discs” (P.8-22)



8

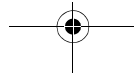

Listen to MP3s

If a disc is already within the product, press the MEDIA key to switch to CD as the source.

NOTE

- Depending on the file structure, it may take some time to read the contents of the disc.

Select the Track (File)

Press the ◀◀ key or ▶▶ key to select the track.

This enables selection of the next or previous track.

Fast Forward or Rewind

Hold down the 3 ◀◀ key or the 4 ▶▶ key.

Fast forward/rewind is possible.

Switch Playback Mode

Repeat playback, random playback, and scan playback are possible.

Repeat Playback (RPT)

Press the 1RPT key.

Repeat playback of the track currently being played.

NOTE

- Pressing again will cancel.
- Selecting a file, ejecting, fast forwarding, or rewinding will cancel.

Folder Repeat Playback

Hold down the 1RPT key.

Repeat playback of the tracks within the folder currently being played.

NOTE

- Pressing again will cancel.
- Even if the file is selected, folder repeat playback will not be cancelled.

Random Playback (RDM)

Press the 2RDM key.

Play the tracks in the folder in a random order.

NOTE

- Pressing again will cancel.

Folder Random Playback

Hold down the 2RDM key.

Play all tracks in folders on the disc in a random order.

NOTE

- Pressing again will cancel.

Scan Playback (SCAN)

Press the SCAN key.

Play the first 10 seconds of each of the tracks in the folder currently being played in order.

Search Tracks

Search folders and files, and select a track.

1. Turn the ▶/SEL key to select the folder.

Listen to an iPod

2. Press the **▶/SEL** key.

Files within the selected folder are displayed.

3. Turn the **▶/SEL** key to select the file.

4. Press the **▶/SEL** key.

This plays the selected file (track).

NOTE

- While the folder is selected, press the **6 ➡** key to cancel track search mode.
- If there is no operation for 10 seconds after selecting the folder, then track search mode will be cancelled.
- Select the folder, and hold down the **▶/SEL** key to start playback from the first track in that folder.
- While the file is selected, press the **6 ➡** key to return to the previous operation.
- While the file is selected, hold down the **6 ➡** key to cancel track search mode.
- If there is no operation for five seconds after selecting the file, that file is played back.
- Disc operations such as selecting a track will cancel track search mode.

8

Listen to an iPod

E00738001071

By connecting commercially-available iPod/iPhone devices to this product, you can play back tracks on these through the product.

CAUTION

- Do not leave the iPod/iPhone unattended in the vehicle.
- Never hold these devices in your hand to operate while driving, as this is dangerous.
- No indemnification for data loss resulting when the iPod/iPhone is connected to the product will be possible.
- Depending on how the devices are handled, audio files being damaged or lost, therefore it is recommended that data be backed up.

NOTE

- Depending on the generation, model, or software version of the iPod/iPhone, playback on this product may not be possible. (→P.8-13) Additionally, playback as explained in this document may not be possible.
- Regarding details such as types of iPod/iPhone that can be connected to equipment by type, and types of files that can be played back, refer to “Types of connectable devices and supported file specifications” on page 8-63.

NOTE

- Usage of iPod/iPhone hardware with the latest software version is recommended.
- Regarding how to connect the iPod/iPhone, refer to “How to connect an iPod” on page 8-62.
- When connecting the iPod/iPhone, use a commercially-available iPod connection cable.
- Set up the device in order that no unsafe actions, such as plugging in the connection cable are taken while driving.
- When inserting and removing the iPod/iPhone, for safety’s sake first stop the vehicle.
- Depending on the status of the iPod/iPhone, it may take some time until the device is recognized, or playback starts.
- Depending on the iPod/iPhone, the button functions on the product may not operate while the iPod/iPhone is connected.
- iPod/iPhone specifications and settings may mean that connection is not possible, or result in differences in operation or display.
- Depending on audio data in the iPod/iPhone, track information may not be displayed correctly.
- Depending on the status of the vehicle and device, the iPod/iPhone may not play back after starting the Plug-in Hybrid EV system.
- Data containing copyright information may not play back.
- It is recommended that the iPod/iPhone equaliser settings be set to flat.

Listen to an iPod

NOTE

- Operate the iPod/iPhone while connected to this product.
- If the iPod/iPhone is connected via Bluetooth as a Bluetooth-capable audio device, then do not connect the iPod/iPhone using an iPod cable. Connection using both methods will result in erroneous operation.
- If an iPod/iPhone does not operate correctly, then remove the iPod/iPhone from the product, reset, then reconnect.

Play iPod

Press the MEDIA key to set the iPod as the source.

The selected source is indicated on the display.

Select the Track (File)

Press the ◀ key or ▶ key to select the track.

This enables selection of the next or previous track.

Fast Forward or Rewind

Hold down the 3◀◀ key or the 4▶▶ key.

Fast forward/rewind is possible.

Switch Playback Mode

Repeat playback and shuffle playback are possible.

Repeat Playback (RPT)

Press the 1RPT key.

Repeat playback of the track currently being played.

NOTE

- Pressing again will cancel.

Shuffle Playback (RDM)

Press the 2RDM key.

Play tracks in the category currently being played in a random order.

NOTE

- Pressing again will cancel.

Album Shuffle Playback

Hold down the 2RDM key.

Play back the album in a random order (tracks in any order on the album).

NOTE

- Pressing again will cancel.

8

Search Tracks

Search categories or track names, and select a track.

1. Turn the ▶/SEL key to select the category.
2. Press the ▶/SEL key. Categories or tracks within the selected category are displayed.
3. Turn the ▶/SEL key to select the category or track.

Listen to Audio Files on a USB Device

4. Press the **▶/SEL** key.
Repeat steps 1 to 4, and search for tracks.
Select the track, and press the **▶/SEL** key to play.

NOTE

- While the category (1st level) is selected, press the **6 ➡** key to cancel track search mode.
- If there is no operation for 10 seconds after selecting the category, then track search mode will be cancelled.
- Select the category, and hold down the **▶/SEL** key to start playback from the first track in that category.
- While the track is selected, press the **6 ➡** key to return to the previous operation.
- While the track is selected, hold down the **6 ➡** key to cancel track search mode.
- If there is no operation for five seconds after selecting the track, that file is played back.
- iPod operations such as selecting a track will cancel track search mode.

Listen to Audio Files on a USB Device

E00736501102

By connecting commercially-available USB devices such as USB memory to this product,

8-30 For pleasant driving

you can play back audio files on these through the product.

CAUTION

- Do not leave the USB device unattended in the vehicle.
- Never hold these devices in your hand to operate while driving, as this is dangerous.
- Do not use hard discs, card readers, or memory readers, as damage may occur to these or to the data contained therein. If these are erroneously connected, then put the operation mode of the power switch in OFF, then remove.
- Because of the risk of data loss, it is recommended that files be backed up.
- No guarantee is made as regards damage to the USB device, nor regarding loss or damage to data contained therein.
- Depending on how the devices are handled, audio files being damaged or lost, therefore it is recommended that data be backed up.

NOTE

- Regarding details such as types of USB devices that can be connected, and USB input ports, refer to “Device types” on page 8-63.
- Regarding details of types of files that can be played back in equipment by type, refer to “File specifications” on page 8-64.

NOTE

- Regarding how to connect USB devices, refer to “How to connect a USB memory device” on page 8-61.
- When connecting a USB device, use a connection cable. Failure to use a connection cable when connecting may place undue load on, or damage the USB connector.
- Set up the device in order that no unsafe actions, such as plugging in the connection cable are taken while driving.
- When inserting and removing the USB device, for safety’s sake first stop the vehicle.
- Do not insert other than audio devices into the USB port. Damage to the device or equipment may result.
- Depending on the status of the USB device, it may take some time until the device is recognized, or playback starts.
- Depending on the USB device, the button functions on the product may not operate while the USB device is connected.
- USB device specifications and settings may mean that connection is not possible, or result in differences in operation or display.
- Depending on audio data in the USB device, track information may not be displayed correctly.
- Depending on the status of the vehicle and device, the iPod/iPhone may not play back after starting the Plug-in Hybrid EV system.
- Data containing copyright information may not play back.

NOTE

- This product can play back MP3, WMA, and AAC format audio files.
- Depending on the type of USB device, usage may not be possible, or functions that can be used may be restricted.
- The recommended file system for USB memory is FAT32.
- The maximum supported capacity for USB memory is 32GB.
- Operate the USB device containing recorded audio files while connected to this product.

Play Back of Audio Files on a USB Device

Press the MEDIA key to set

USB as the source. The selected source is indicated on the display.

Select the Track (File)

Press the **1**◀ key or ▶**1** key to select the track.

This enables selection of the next or previous track.

Fast Forward or Rewind

Hold down the **3**◀◀ key or the ▶▶**4** key.

Fast forward/rewind is possible.

Switch Playback Mode

Repeat playback, random playback, and scan playback are possible.

Repeat Playback (RPT)

Press the **1**RPT key.

Repeat playback of the track currently being played.

NOTE

- Pressing again will cancel.
- Selecting a file will cancel this.

Folder Repeat Playback

Hold down the **1**RPT key.

Repeat playback of the tracks within the folder currently being played.

Listen to Audio Files on a USB Device

NOTE

- Pressing again will cancel.
- Even if the file is selected, folder repeat playback will not be cancelled.

Folder Random Playback (RDM)

Press the **2**RDM key.

Play tracks in the folder currently being played in a random order.

NOTE

- Pressing again will cancel.
- Even if the file is selected, folder random playback will not be cancelled.

All Folder Random Playback

Hold down the **2**RDM key.

Play the tracks in all folders in a random order.

NOTE

- Pressing again will cancel.
- Even if the file is selected, all folder random playback will not be cancelled.

Listen to Bluetooth Audio

Scan Playback (SCAN)

Press the SCAN key. Play the first 10 seconds of each of the tracks on the whole USB device in order.

NOTE

- Press this button again during playback if you wish to hear that track, and that track will play normally.

8 Folder Scan Playback

Hold down the SCAN key.

Play the first 10 seconds of the first track in each folder on the USB device in order.

NOTE

- Press this button again during playback if you wish to hear that track, and that track will play normally.

Search Tracks



Search folders and files, and select a track.

1. Turn the  /SEL key to select the folder.

8-32 For pleasant driving





2. Press the  /SEL key.

Files within the selected folder are displayed.

3. Turn the  /SEL key to select the file.
4. Press the  /SEL key.

This plays the selected file (track).

NOTE

- While the folder is selected, press the 6  key to cancel track search mode.
- If there is no operation for 10 seconds after selecting the folder, then track search mode will be cancelled.
- Select the folder, and hold down the  /SEL key to start playback from the first track in that folder.
- While the file is selected, press the 6  key to return to the previous operation.
- While the file is selected, hold down the 6  key to cancel track search mode.
- If there is no operation for five seconds after selecting the file, that file is played back.
- Operations such as selecting a track will cancel track search mode.

Listen to Bluetooth Audio

E00736701104

This product can play back tracks on commercially-available Bluetooth-capable audio devices.

CAUTION

- Never hold these devices in your hand to operate while driving, as this is dangerous.
- Do not leave the Bluetooth audio device unattended in the vehicle.
- Depending on how the devices are handled, audio files being damaged or lost, therefore it is recommended that data be backed up.

NOTE

- Depending on the type of Bluetooth-capable audio devices, usage may not be possible, or functions that can be used may be restricted.
- Confirm together with the user manuals for the commercially-available Bluetooth-capable audio devices.
- Depending on the type of Bluetooth-capable audio devices, volume levels may differ. There is the danger of loud volumes, so prior to use, it is recommended that you turn the volume down.
→ “Adjust Volume” (P.8-22)
- Depending on the status of the Bluetooth audio device, it may take some time until the device is recognized, or playback starts.

Listen to Bluetooth Audio

NOTE

- Bluetooth audio device specifications and settings may mean that connection is not possible, or result in differences in operation or display.
- Depending on audio data in the Bluetooth audio device, track information may not be displayed correctly.
- Depending on the status of the vehicle and device, the iPod/iPhone may not play back after starting the Plug-in Hybrid EV system.

Connect a Bluetooth-capable Audio Device

Regarding how to connect your Bluetooth device, refer to “Connecting the Bluetooth® 2.0 interface and Bluetooth device” on page 8-47.

Operation methods below describe situations once connection has been completed.

NOTE

- If the iPod/iPhone is connected via Bluetooth as a Bluetooth-capable audio device, then do not connect the iPod/iPhone using an iPod cable. Connection using both methods will result in erroneous operation.



Play Bluetooth Audio

1. Press the MEDIA key to set Bluetooth Audio as the source.



The selected source is indicated on the display.

2. Press the 5  key. Bluetooth Audio playback starts.

NOTE

- Hold down the 5  key to pause.
- Press the 6  key to stop.

Select the Track (File)

Press the  key or  key to select the track.

This enables selection of the next or previous track.

Fast Forward or Rewind

Hold down the 3  key or the 4  key.

Fast forward/rewind is possible.

Switch Playback Mode

Repeat playback, random playback, and scan playback are possible.

Repeat Playback (RPT)

Press the 1RPT key.

Repeat playback of the track currently being played.

NOTE

- Each time the 1RPT key is pressed, this switches in the order Repeat OFF, 1 track repeat, All track repeat, and Repeat OFF.

Random Playback (RDM)

Press the 2RDM key.

Play the tracks in the Bluetooth Audio device in a random order.

NOTE

- Pressing again will cancel.

8

To listen to a disc in the rear-seat display (vehicles with rear-seat display)

Scan Playback (SCAN)

Press the SCAN key.

Play the first 10 seconds of each of the tracks on the whole Bluetooth Audio device in order.

NOTE

- Press this button again during playback if you wish to hear that track, and that track will play normally.

To listen to a disc in the rear-seat display (vehicles with rear-seat display)

E00755100168

It is possible to listen to the audio from the rear-seat display using the vehicle's speakers.

Hold down the MEDIA key.
Switch to the AUX mode, and "AUX" is displayed.

NOTE

- For more details about the rear-seat display, refer to the separate owner's manual.

8

Display Indicator

E00738100033

This explains content of the display indicator.



AA1008779

8-34 For pleasant driving

Audio Quality and Volume Balance Adjustment

Change the Display Mode

E00738501076

You can change the content of the display indicator.
Press the DISP key to switch the display content.

Each time the DISP key is pressed, the display content changes.

CAUTION

- The operation of changing display contents may impede safe driving, therefore check safety before operation.

NOTE

- Up to 11 characters may be displayed at one time. To display 12 or more characters, press the PAGE key, and subsequent characters will be displayed.

During CD-DA playback

This switches in the order “Disc title”, “Track title”, and “Operating status”.

NOTE

- If there is no text information to display, then “NO TITLE” is displayed.

During MP3/WMA/AAC Playback

This switches in the order “Folder title”, “File title”, and “Operating status”.

NOTE

- If there is no text information to display, then “NO TITLE” is displayed.

Display the ID3tag

Hold down the DISP key.

This switches the ID3tag display.
[DISP] Each time the key is pressed, this switches in the order “Album name”, “Track name”, “Artist name”, “Genre name”*, and “Operating status”.

*:Displayed when playing back audio files on a USB device.

NOTE

- During display of the ID3tag, hold down the DISP key to switch to the folder title display.
- The genre name display may not be possible.

During iPod Playback

E00738901038

This switches in the order “Albums”, “Track name”, “Artist name”, “Genre name”*, and “Operating status”.

NOTE

- If there is no text information to display, then “NO TITLE” is displayed.
- Displayed genre name in equipment by type.
- The genre name display may not be possible.

8

During Bluetooth® 2.0 Audio Playback

E00739001023

Operating details are the same as in “During iPod Playback” (P.8-35).

Audio Quality and Volume Balance Adjustment

E00738200021

Change audio quality settings.

System Settings

Adjust Audio Quality and Volume Balance

1. Press the **▶/SEL** key to select settings items.

Each time the **▶/SEL** key is pressed, this switches in the order BASS, TREBLE, FADER, BALANCE, SCV, and Cancel.

2. Turn the **▶/SEL** key to adjust.

8

Adjustment items	Turn counter-clockwise	Turn clockwise
BASS	-6 to 0 (low low-pass volume)	0 to +6 (high low-pass volume)
TREBLE	-6 to 0 (Low high-pass volume)	0 to +6 (High high-pass volume)
FADER	CENTER to REAR 11 (emphasise REAR)	FRONT 11 to CENTER (emphasise FRONT)
BALANCE	LEFT 11 to CENTER (emphasise LEFT)	CENTER to RIGHT 11 (emphasise RIGHT)

8-36 For pleasant driving

Adjustment items	Turn counter-clockwise	Turn clockwise
SCV	OFF, LOW (Low vehicle compensated volume effect)	MID, HIGH (High vehicle compensated volume effect)

System Settings

E00738301087

Change system settings such as product time.

1. Press the MENU key.
2. Press the **▶/SEL** key to select settings items.

Each time the **▶/SEL** key is pressed, this switches in the order Gracenote DB*, PHONE settings, Adjust time, and Cancel.

3. Turn the **▶/SEL** key to set.
4. Press the **▶/SEL** key to determine.

This completes settings, and displays the next settings item.

*:Displayed when playing back audio files.

Time Setting

Set the time manually.

1. Select “YES” at the “Adjust time” screen, and press the **▶/SEL** key.

The hour can be adjusted. Press the **▶/SEL** key again to adjust the minutes.

2. Turn the **▶/SEL** key to adjust the time.
3. Press the **▶/SEL** key.

This completes the adjustment.

NOTE

- In order to finish adjusting the time, hold down the **▶/SEL** key until the seconds are reset to “00”.

Gracenote DB

The version number can be confirmed.

1. Select “Gracenote DB” and press the **▶/SEL** key.
2. Turn the **▶/SEL** key and select “DB Version”.
3. Press the **▶/SEL** key.
The DB Version is displayed.

PHONE Settings

Change the mobile phone voice cut-in settings and the Bluetooth® 2.0 interface language.

Depending on the vehicle, PHONE settings may not be possible.

NOTE

- Cancel functions such as the mobile phone “dial lock”, and connect while on the standby screen.
- While connected, mobile phone (receiving calls, etc.) operations may not function correctly.
- Depending on the distance between the product and the mobile phone, the conditions within the vehicle, and types of screening, connection may not be possible. In these cases, situate the mobile phone as close as possible to the product.
- Even though a Bluetooth-capable mobile phone, characteristics and specifications may mean that correct operation may not be possible.
- For safety’s sake, do not operate the mobile phone while driving. When operating the mobile phone, first stop the vehicle in a safe location.

NOTE

- Even though a Bluetooth-capable mobile phone, phone specifications and settings may result in differences in display, or prevent correct operation.
- Some models may not be confirmed as connected, or may not connect.

Supported profiles

Hands-free	HFP(v1.5)
Phonebook transfer	OPP(v1.1), PBAP(v1.0)

(“Set value” bold typeface indicates factory default settings.)

Settings name	Settings value	Settings content
PHONE IN settings	PHONE IN-R	During mobile phone voice cut-in, output sound from the right front speaker.
	PHONE IN-L	During mobile phone voice cut-in, output sound from the left front speaker.

Settings name	Settings value	Settings content
HFM voice language settings	ENGLISH	Change the hands free module voice language.
	FRENCH	
	GERMAN	
	SPANISH	
	ITALIAN	
	DUTCH	
	PORTUGUESE	
	RUSSIAN	

NOTE

- Depending on the vehicle model, this may not display.

Troubleshooting

Troubleshooting

E00738401075

Please check these items if a message appears on the display, or if you think something is not working properly.

If This Message Appears...

A message is displayed on this product according to the situation.

8

Mode	Message	Cause	Response
CD	CHECK DISC	The disc is inserted upside down.	Insert with the label side up.
		The disc has condensation on it.	Wait a while before inserting again.
	DISC ERROR	The disc is damaged.	Clean the read surface of the disc.
		The disc is dirty.	
	INTERNAL E	The drive has malfunctioned for some reason.	Check that there is no problem with the disc, and insert the disc again. If the problem persists, consult a MITSUBISHI MOTORS Authorised Service Point.
HEAT ERROR	The temperature inside the product is high.	Remove the disc, and wait for the internal temperature to return to normal.	

Troubleshooting

Mode	Message	Cause	Response
USB	FILE ERROR	Files that cannot be played are selected.	Select files that can be played. → “Audio Files (MP3/WMA/AAC)” (P.8-17)
	USB BUS PWR	There is high or low electrical current or voltage.	Turn the power OFF and wait a short while. If the problem persists, consult a MITSUBISHI MOTORS Authorised Service Point.
	LSI ERROR	There is an internal malfunction for some reason.	
	UNSUPPORTED FORMAT	Unsupported audio files have been played.	Confirm audio files that can be played. → “Audio Files (MP3/WMA/AAC)” (P.8-17)
	UNSUPPORTED DEVICE	An unsupported USB device has been connected.	Please connect a USB memory device.
iPod	NO SONG	An iPod/iPhone not containing any tracks has been connected.	Connect an iPod/iPhone containing tracks.
	VER ERROR	This iPod/iPhone software version is not supported.	Please change to a supported software version.
Other	ERROR DC	An abnormal direct voltage has been sent to the speakers.	Turn the power OFF and wait a short while. If the problem persists, consult a MITSUBISHI MOTORS Authorised Service Point.

8

If You Think Something Is Not Working Properly...

Here is a list of symptoms, causes and responses if you think something is not working properly.

Symptoms	Cause	Response
There is no sound or quiet sound.	The volume is turned to its minimum.	Adjust the volume. → “Adjust Volume” (P.8-22)
	The balance or fader is turned to one side.	Adjust the balance or fader. → “Adjust Audio Quality and Volume Balance” (P.8-35)

Antenna

Symptoms	Cause	Response
The disc cannot be inserted.	A disc is already in the product.	Eject the disc. → “Insert/Eject Discs” (P.8-22)
	There is no disc in the product, but the product says it is loading.	Press the eject button once. → “Insert/Eject Discs” (P.8-22)
The disc cannot be played.	The disc is inserted upside down.	Insert with the label side up.
	The disc has condensation on it.	Wait a while before inserting.
	The disc is dirty.	Clean the read surface of the disc.
The sound skips in the same place.	The disc is damaged or dirty.	Check the disc.
There is no sound, even if the disc is inserted.	Damage to or dirt on the disc means that its data cannot be read.	Check the disc. Additionally, if using CD-R/RW discs, their characteristics may render them unable to be played.

8

Antenna

E00710500686

To remove

Turn the pole (A) anticlockwise.

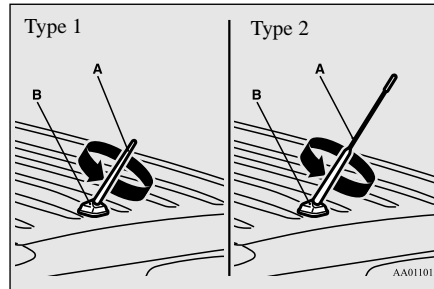

To install

Screw the pole (A) clockwise into the base (B) until it is securely retained.

NOTE

- Be sure to remove the roof antenna in the following cases:
 - When going into an automatic car wash.
 - When placing a car cover over the vehicle.
 - When driving into a structure that has a low ceiling.

Link System

E00764501279

The Link System takes overall control of the devices connected via the USB input terminal or the Bluetooth® 2.0 interface allowing the connected devices to be operated by using the switches in the vehicle or voice commands.

See the following section for details on how to operate.

Refer to “Bluetooth® 2.0 interface” on page 8-41.

Refer to “USB input terminal” on page 8-61.

Bluetooth® is a registered trademark of BLUETOOTH SIG, INC.

Link System End User License Agreement

E00764600013

You have acquired a device that includes software licensed by MITSUBISHI MOTORS CORPORATION from JOHNSON CONTROLS Inc (the automotive experience business unit), and their subsequent 3rd party suppliers. For a complete list of these 3rd party products and their end user license agreements, please go to the following website.

<http://www.jciblueconnect.com/faq/fulldisclosure.pdf>

Bluetooth® 2.0 interface

E00726001902

The Bluetooth® 2.0 interface allows for making/receiving hands-free calls in the vehicle using a Bluetooth® compatible cellular phone

based on the wireless communication technology commonly known as Bluetooth®. It also allows the user to play music, saved in a Bluetooth® music player, from the vehicle’s speakers.

The system is equipped with a voice recognition function, which allows you to make hands-free calls by simple switch operations and voice command operations using a defined voice tree.

The Bluetooth® 2.0 interface can be used when the operation mode is in ON or ACC.

Before you can use the Bluetooth® 2.0 interface, you must pair the Bluetooth® device and Bluetooth® 2.0 interface. Refer to “Connecting the Bluetooth® 2.0 interface and Bluetooth® device” on page 8-47.

Bluetooth® is a registered trademark of BLUETOOTH SIG, INC.

Bluetooth® 2.0 interface

WARNING

- Although the Bluetooth® 2.0 interface allows you to make hands-free calls, if you choose to use the cellular phone while driving, you must not allow yourself to be distracted from the safe operation of your vehicle. Anything, including cellular phone usage, that distracts you from the safe operation of your vehicle increases your risk of an accident.
- Refer to and comply with all state and local laws in your area regarding cellular phone usage while driving.

8

NOTE

- If the operation mode is left in ACC, the accessory power will automatically turn off after a certain period of time and you will no longer be able to use the Bluetooth® 2.0 interface. The accessory power comes on again if the power switch is operated. Refer to “ACC power auto-cutout function” on page 7-11.
- The Bluetooth® 2.0 interface cannot be used if the Bluetooth® device has a flat battery or the device power is turned off.
- Hands-free calls will not be possible if your phone does not have service available.
- If you place the Bluetooth® device in the luggage compartment, you may not be able to use the Bluetooth® 2.0 interface.

For pleasant driving 8-41

Bluetooth® 2.0 interface

NOTE

- Some Bluetooth® devices are not compatible with the Bluetooth® 2.0 interface.
- You can confirm the Link System software version by pressing the HANG-UP button 3 times (press and hold 2 times and then press briefly) within 10 seconds.
- For detail of the Bluetooth® 2.0 interface (hands-free/Link system), you can access via the MITSUBISHI MOTORS web site. Please read and agree to the “Warning about Links to the Web Sites of Other Companies” because it connects to an external link. <http://www.mitsubishi-motors.com/en/products/index.html>
- Software updates by cellular phone/digital audio device manufacturers may change/alter device connectivity.

8

Steering control switch and microphone
→ P.8-42

Voice recognition function → P.8-43

Useful voice commands → P.8-44

Speaker enrollment function → P.8-45

Connecting the Bluetooth® 2.0 interface and the Bluetooth® device → P.8-47

Operating a music player connected via Bluetooth® → P.8-51

How to make or receive hands-free calls
→ P.8-51

Phonebook function → P.8-54

Steering control switch and microphone

E00727200308

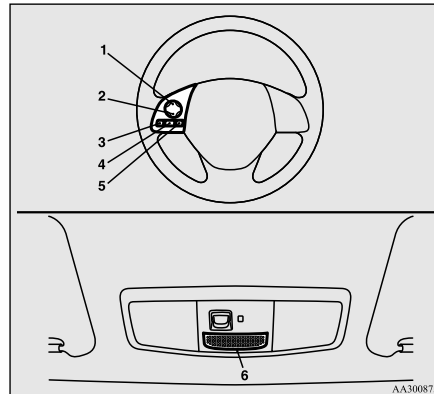

- 1- Volume up button
- 2- Volume down button
- 3- SPEECH button
- 4- PICK-UP button
- 5- HANG-UP button
- 6- Microphone

Volume up button

Press this button to increase the volume.

Volume down button

Press this button to decrease the volume.

SPEECH button

- Press this button to change to voice recognition mode. While the system is in voice recognition mode, “Listening” will appear on the audio display.
- If you press the button briefly while in voice recognition mode, it will interrupt prompting and allow voice command input. Pressing the button longer will deactivate the voice recognition mode.
- Pressing this button briefly during a call will enable voice recognition and allow voice command input.

PICK-UP button

- Press this button when an incoming call is received to answer the telephone.
- When another call is received during a call, press this button to put the first caller on hold and talk to the new caller.

8-42 For pleasant driving

- In such circumstances, you can press the button briefly to switch between callers. You will switch to the first caller and the other caller will be put on hold.
- To establish a three-way call in such situations, press the SPEECH button to enter voice recognition mode and then say “Join calls.”

HANG-UP button

- Press this button when an incoming call is received to refuse the call.
- Press this button during a call to end the current call.
When another call is on hold, you will switch to that call.
- If this button is pressed in the voice recognition mode, the voice recognition mode will be deactivated.

NOTE

- When you press the SPEECH button to enter voice recognition mode with a cellular phone paired to the system, current information on the cellular phone, such as “remaining battery life,” “signal strength” or “roaming,” will be displayed on the audio display.*
*: Some cellular phones will not send this information to the Bluetooth® 2.0 interface.

NOTE

- Call waiting and three-way calls can be used by the Bluetooth® 2.0 interface, only if it is possible to use those services with your cellular phone.

Microphone

Your voice will be recognized by a microphone in the overhead console, allowing you to make hands-free calls with voice commands.

NOTE

- If a cellular phone is brought close to the microphone, it may create noise in the voice on the phone. In such a case, take the cellular phone to a place as far as possible from the microphone.

Voice recognition function

E00727300514

The Bluetooth® 2.0 interface is equipped with a voice recognition function. Simply say voice commands and you can perform various operations and make or receive hands-free calls.

With the Bluetooth® 2.0 interface, voice recognition is possible for English, French,

Bluetooth® 2.0 interface

Spanish, Italian, German, Dutch, Portuguese and Russian. The factory setting is “English” or “Russian.”

NOTE

- If the voice command that you say differs from the predefined command or cannot be recognised due to ambient noise or some other reason, the Bluetooth® 2.0 interface will ask you for the voice command again up to 3 times.
- For best performance and further reduction of ambient noise, the vehicle windows should be closed, lower the blower speed and refrain from conversation with your passengers while engaging the voice recognition function.
- Some voice commands have alternative commands.
- Depending on the selected language, some functions may not be available.

8

Selecting the language

1. Press the SPEECH button.
2. Say “Setup.”
3. Say “Language.”
4. The voice guide will say “Select a language: English, French, Spanish, Italian, German, Dutch, Portuguese or Russian” Say the desired language. (Example: “English”)

Bluetooth® 2.0 interface

5. The voice guide will say “English (French, Spanish, Italian, German, Dutch, Portuguese or Russian) selected. Is this correct?” Say “Yes.”

If you say “No,” the system will return to Step 4.

NOTE

- The voice guide will repeat the same message twice. The first message is in the current language, and the second message is in the selected language.
- If many entries are registered in the vehicle phonebook, changing the language will take a longer time.
- Changing the language deletes the mobile phonebook imported to the Bluetooth® 2.0 interface. If you wish to use it, you will have to import it again.

8

6. When the voice guide says “English (French, Spanish, Italian, German, Dutch, Portuguese or Russian) selected,” the language change process will be completed and the system will return to the main menu.

Useful voice commands

E0076000019

Help function

E00760100010

The Bluetooth® 2.0 interface is equipped with a help function.

If you say “Help” when the system is waiting for a voice command input, the system will tell you a list of the commands that can be used under the circumstances.

Canceling

E00760200011

There are 2 cancel functions.

If you are at the main menu, say “Cancel” to exit from the Bluetooth® 2.0 interface.

If you are anywhere else within the system, say “Cancel” to return to the main menu.

Confirmation function setting

E00760400013

The Bluetooth® 2.0 interface is equipped with a confirmation function.

With the confirmation function activated, you are given more opportunities than normal to confirm a command when making various settings to the Bluetooth® 2.0 interface. This

allows you to decrease the possibility that a setting is accidentally changed.

The confirmation function can be turned on or off by following the steps below.

1. Press the SPEECH button.
2. Say “Setup.”
3. Say “Confirmation prompts.”
4. The voice guide will say “Confirmation prompts are <on/off>. Would you like to turn confirmation prompts <off/on>.” Answer “Yes” to change the setting or answer “No” to keep the current setting.
5. The voice guide will say “Confirmation prompts are <off/on>” and then the system will return to the main menu.

Security function

E00760501242

It is possible to use a password as a security function by setting a password of your choice for the Bluetooth® 2.0 interface.

When the security function is turned on, it is necessary to make a voice input of a 4-digit password in order to use all functions of the Bluetooth® 2.0 interface, except for reception.

Setting the password

Use the following procedure to turn on the security function by setting a password.

Bluetooth® 2.0 interface

1. Press the SPEECH button.
2. Say "Setup."
3. Say "Password."
4. The voice guide will say "Password is disabled. Would you like to enable it?" Answer "Yes."
Answer "No" to cancel the setting of the password and return to the main menu.
5. The voice guide will say "Please say a 4-digit password. Remember this password. It will be required to use this system."
Say a 4-digit number which you want to set as a password.
6. For confirmation purposes, the voice guide will say "Password <4-digit password>. Is this correct?" Answer "Yes."
Answer "No" to return to the password input in Step 5.
7. When the registration of the password is completed, the voice guide will say "Password is enabled" and the system will return to the main menu.

NOTE

- After activating Plug-in Hybrid EV system again and pressing SPEECH button, you are asked to tell your password.

NOTE

- The set password is actually recorded in the Link system after a while after the ready indicator goes out.
If you set the operation mode to ACC or ON or activate Plug-in Hybrid EV system soon after the ready indicator goes out, the set password may not be recorded in the Link system in some cases. In such a case, set your password again.

Entering the password

If a password has been set and the security function is enabled, the voice guide will say "Hands-free system is locked. State the password to continue" when the SPEECH button is pressed to enter voice recognition mode. Say the 4-digit password number to enter the password.

If the entered password is wrong, the voice guide will say "<4-digit password>, Incorrect password. Please try again." Enter the correct password.

NOTE

- You can reenter the password as many times as you want.
- If you have forgotten your password, say "Cancel" to quit the voice input mode and then check with a MITSUBISHI MOTORS Authorised Service Point.

Disabling the password

Use the following procedure to turn off the security function by disabling the password.

NOTE

- System must be unlocked to disable the password.

1. Press the SPEECH button.
2. Say "Setup."
3. Say "Password."
4. The voice guide will say "Password is enabled. Would you like to disable it?" Answer "Yes."
Answer "No" to cancel the disabling of the password and return to the main menu.
5. When the disabling of the password is completed, the voice guide will say "Password is disabled" and the system will return to the main menu.

8

Speaker enrollment function

E00727400209

The Bluetooth® 2.0 interface can use the speaker enrollment function to create a voice model for one person per language.



Bluetooth® 2.0 interface

This makes it easier for the Bluetooth® 2.0 interface to recognise voice commands said by you.

You can turn a voice model registered with the speaker enrollment function on and off whenever you want.

Speaker enrollment

E00727501294

It takes about 2 to 3 minutes to complete the speaker enrollment process.

8

To ensure the best results, run through the process while in the driver's seat, in an environment that is as quiet as possible (when there is no rain or strong winds and the vehicle windows are closed). Please turn off your phone while in speaker enrollment to prevent interruption of the process.

Use the following procedure for speaker enrollment.

1. Stop your vehicle in a safe area, firmly apply the parking brake and push the electrical parking switch.

NOTE

- Speaker enrollment is not possible unless the vehicle is parked. Make sure you park the vehicle in a safe area before attempting speaker enrollment.

2. Press the SPEECH button.

8-46 For pleasant driving



3. Say "Voice training."

4. The voice guide will say "This operation must be performed in a quiet environment while the vehicle is stopped. See the owner's manual for the list of required training phrases. Press and release the SPEECH button when you are ready to begin. Press the HANG-UP button to cancel at any time."

Press the SPEECH button to start the speaker enrollment process.

NOTE

- If you do not start the speaker enrollment process within 3 minutes after pressing the SPEECH button, the speaker enrollment function will time out.
The voice guide will say "Speaker enrollment has timed out." The system will then beep and the voice recognition mode will be deactivated.

5. The voice guide will prompt for phrase 1. Repeat the corresponding phrase listed in table "Enrollment commands" on page 8-61.

The system will register your voice and then move on to the registration of the next command. Continue the process until all phrases have been registered.

NOTE

- To repeat the most recent voice training command, press and release the SPEECH button.
- If you press the HANG-UP button anytime during the process, the system will beep and stop the speaker enrollment process.

6. When all enrollment commands have been read out, the voice guide will say "Speaker enrollment is complete." The system will then end the speaker enrollment process and return to the main menu.

NOTE

- Completing the speaker enrollment process will turn on the voice model automatically.
- The commands "Help" and "Cancel" will not work in this mode.



Enabling and disabling the voice model and retraining

E00727600096

You can turn a voice model registered with the speaker enrollment function on and off whenever you want.

You can also retrain the system.

Use the following procedure to perform these actions.

1. Press the SPEECH button.
2. Say "Voice training."
3. If you have completed a speaker enrollment process once already, the voice guide will say either "Enrollment is enabled. Would you like to disable or retrain?" or "Enrollment is disabled. Would you like to enable or retrain?"
4. When enrollment is "enabled," the voice model is on; when enrollment is "disabled," the voice model is off. Say the command that fits your needs. Say "Retrain" to start the speaker enrollment process and recreate a new voice model. (Refer to "Speaker enrollment" on page 8-46.)

Connecting the Bluetooth® 2.0 interface and Bluetooth® device

E00760601399

Before you can make or receive hands-free calls or play music using the Bluetooth® 2.0 interface function, you must pair the Bluetooth® device and Bluetooth® 2.0 interface.

NOTE

- Pairing is required only when the device is used for the first time. Once the device has been paired with the Bluetooth® 2.0 interface, all you need is to bring the device into the vehicle next time and the device will connect to the Bluetooth® 2.0 interface automatically (if supported by the device). The device must have Bluetooth® turned ON to connect.

Up to 7 Bluetooth® devices can be paired with the Bluetooth® 2.0 interface.

If multiple paired Bluetooth® devices are available in the vehicle, the cellular phone or music player most recently connected is automatically connected to the Bluetooth® 2.0 interface.

You can also change a Bluetooth® device to be connected.

To pair

To pair a Bluetooth® device with the Bluetooth® 2.0 interface, follow the steps below.

1. Stop your vehicle in a safe area, firmly apply the parking brake and push the electrical parking switch.

NOTE

- You cannot pair any Bluetooth® device with the Bluetooth® 2.0 interface unless the vehicle is parked. Before pairing a Bluetooth® device with the Bluetooth® 2.0 interface, confirm that the vehicle is parked in a safe location.

2. Press the SPEECH button.
3. Say "Setup."
4. Say "Pairing Options."

Bluetooth® 2.0 interface

5. The voice guide will say “Select one of the following: pair, edit, delete, or list.” Say “Pair.”

NOTE

- If 7 devices have already been paired, the voice guide will say “Maximum devices paired” and then the system will end the pairing process. To register a new device, delete one device and then repeat the pairing process. (Refer to “Selecting a device: Deleting a device” on page 8-49.)

8

6. The voice guide will say “Please say a 4-digit pairing code.” Say a 4-digit number. When the confirmation function is on, the system will confirm whether the number said is acceptable. Answer “Yes.” Answer “No” to return to pairing code selection.

NOTE

- Some Bluetooth® devices require a specific pairing code. Please refer to the device manual for pairing code requirements.

NOTE

- The pairing code entered here is only used for the Bluetooth® connection certification. It is any 4-digit number the user would like to select. Remember the pairing code as it needs to be keyed into the Bluetooth® device later in the pairing process. Depending on the connection settings of the Bluetooth® device, this code may have to be entered each time you connect the Bluetooth® device to the Bluetooth® 2.0 interface. For the default connection settings, refer to the instructions for the device.

7. The voice guide will say “Start pairing procedure on the device. See the device manual for instructions.” Enter in the Bluetooth® device the 4-digit number you have registered in Step 6.

NOTE

- According to the corresponding device to Bluetooth®, it might take a few minute to pair the Bluetooth® device with the Bluetooth® 2.0 interface.

NOTE

- If the Bluetooth® 2.0 interface cannot recognize the Bluetooth® device, the voice guide will say “Pairing has timed out” and the pairing process will be cancelled. Confirm that the device you are pairing supports Bluetooth®, and try pairing it again.
- If you enter the wrong number, the voice guide will say “Pairing failed” and the pairing process will be cancelled. Confirm the number is right, and try pairing it again.

8. The voice guide will say “Please say the name of the device after the beep.” You can assign a desired name for the Bluetooth® device and register it as a device tag. Say the name you want to register after the beep.

NOTE

- When the confirmation function is on, after repeating the device tag you have said, the voice guide will ask “Is this correct?” Answer “Yes.” To change the device tag, answer “No” and then say the device tag again.

9. The voice guide will say “Pairing complete,” after which a beep will be played and the pairing process will end.

Selecting a device

E00760700104

If multiple paired Bluetooth® devices are available in the vehicle, the cellular phone or music player most recently connected is automatically connected to the Bluetooth® 2.0 interface.

You can connect to the other paired cellular phone or music player by following setting change procedures.

To select a cellular phone

1. Press the SPEECH button.
2. Say "Setup."
3. Say "Select phone."

4. After the voice guide says "Please say," the numbers of the cellular phones and device tags of corresponding cellular phones will be read out in order, starting with the cellular phone that has been most recently connected.

Say the number of the cellular phone that you want to connect to.

When the confirmation function is on, the system will ask you again whether the phone that you want to connect to is correct. Answer "Yes" to continue and connect to the cellular phone.

Answer "No," and the voice guide will say "Please say." Say the number of the phone that you want to connect to.

NOTE

- You can connect to a phone at any time by pressing the SPEECH button and saying the number, even before all of the paired numbers and device tags of corresponding cellular phones are read out by the system.

5. The selected phone will be connected to the Bluetooth® 2.0 interface. The voice guide will say "<device tag> selected" and then the system will return to the main menu.

To select a music player

1. Press the SPEECH button.
 2. Say "Setup."
 3. Say "Select music player."
 4. After the voice guide says "Please say," the numbers of the music players and device tags of corresponding music players will be read out in order, starting with the music player that has been most recently connected.
- Say the number of the music player that you want to connect to.

When the confirmation function is on, the system will ask you again whether the music player that you want to connect to is correct. Answer "Yes" to continue and connect to the music player.

Answer "No," and the voice guide will say "Please say." Say the number of the music player that you want to connect to.

NOTE

- You can connect to a music player at any time by pressing the SPEECH button and saying the number, even before all of the paired numbers and device tags of corresponding music players are read out by the system.

Bluetooth® 2.0 interface

5. The selected music player will be connected to the Bluetooth® 2.0 interface. The voice guide will say “<device tag> selected” and then the system will return to the main menu.

Deleting a device

Use the following procedure to delete a paired Bluetooth® device from the Bluetooth® 2.0 interface.

8

1. Press the SPEECH button.
2. Say “Setup.”
3. Say “Pairing Options.”
4. The voice guide will say “Select one of the following: pair, edit, delete, or list.” Say “Delete.”
5. After the voice guide says “Please say,” the numbers of the devices and device tags of corresponding devices will be read out in order, starting with the device that has been most recently connected. After it completes reading all pairs, the voice guide will say “or all.” Say the number of the device that you want to delete from the system. If you want to delete all paired phones from the system, say “All.”

6. For confirmation purposes, the voice guide will say “Deleting <device tag> <number>. Is this correct?” or “Deleting all devices. Is this correct?”

Answer “Yes” to delete the phone(s).

Answer “No,” the system will return to Step 4.

7. The voice guide will say “Deleted,” and then the system will end the device deletion process.

NOTE

- If the device deletion process fails for some reason, the voice guide will say “Delete failed” and then the system will cancel deleting the device.

To check a paired Bluetooth® device

E00760800017

You can check a paired Bluetooth® device by following the steps below.

1. Press the SPEECH button.
2. Say “Setup.”
3. Say “Pairing Options.”
4. The voice guide will say “Select one of the following: pair, edit, delete, or list.” Say “List.”

5. The voice guide will read out device tags of corresponding devices in order, starting with the Bluetooth® device that has been most recently connected.

6. After the device tags of all paired Bluetooth® devices have been read, the system will say “End of list, would you like to start from the beginning?”

To hear the list again from the beginning, answer “Yes.”

When you are done, answer “No” to return to the main menu.

NOTE

- If you press and release the SPEECH button and say “Continue” or “Previous” while the list is being read, the system will advance or rewind the list. Say “Continue” to proceed to the device with the next highest number or “Previous” to return to the phone with the previous number.
- You can change the device tag by pressing and releasing the SPEECH button and then saying “Edit” while the list is being read.
- You can change the phone to be connected by pressing and releasing the SPEECH button and then saying “Select phone” while the list is being read.
- You can change the music player to be connected by pressing and releasing the SPEECH button and then saying “Select music player” while the list is being read.

Bluetooth® 2.0 interface

Changing a device tag

E00760900018

You can change the device tag of a paired cellular phone or music player. Follow the steps below to change a device tag.

1. Press the SPEECH button.
2. Say "Setup."
3. Say "Pairing Options."
4. The voice guide will say "Select one of the following: pair, edit, delete, or list." Say "Edit."
5. The voice guide will say "Please say," and read out the numbers of the Bluetooth® devices and device tags of corresponding devices in order, starting with the Bluetooth® that has been most recently connected. After all paired device tags have been read, the voice guide will say "Which device, please?" Say the number of the device tag you want to change.

NOTE

- You can press and release the SPEECH button while the list is being read, and immediately say the number of the device tag you want to change.

6. The voice guide will say "New name, please." Say the name you want to register as a new device tag.

When the confirmation function is on, the voice guide will say "<New device tag>. Is this correct?" Answer "Yes."

Answer "No," you can say the new device tag you want to register again.

7. The device tag is changed.

When the change is complete, the voice guide will say "New name saved" and then the system will return to the main menu.

Operating a music player connected via Bluetooth®

E00761001156

For the operation of a music player connected via Bluetooth®, refer to "Listen to Bluetooth Audio" on page 8-32. On vehicles equipped with Mitsubishi Multi-Communication System (MMCS) or DISPLAY AUDIO, refer to separate owner's manual.

How to make or receive hands-free calls

E00761100059

You can make or receive hands-free calls using a Bluetooth® compatible cellular phone connected to the Bluetooth® 2.0 interface.

You can also use the phonebooks in the Bluetooth® 2.0 interface to make calls without dialling telephone numbers.

To make a call P.8-51

Send function P.8-53

Receiving calls P.8-53

Mute function P.8-53

Switching between hands-free mode and private mode P.8-54

NOTE

- The hands-free calls might not be operated correctly when it makes calling or receiving by operating the cellular phone directly.

8

To make a call

E00761200148

You can make a call in the following 3 ways using the Bluetooth® 2.0 interface:

Making a call by saying a telephone number, making a call using the Bluetooth® 2.0 interface's phonebook, and making a call by redialing.

Making a call by using the telephone number

You can make a call by saying the telephone number.

For pleasant driving 8-51

Bluetooth® 2.0 interface

1. Press the SPEECH button.
2. Say "Dial."
3. After the voice guide says "Number please," say the telephone number.
4. The voice guide will say "Dialing <number recognized>."

The Bluetooth® 2.0 interface will then make the call.

When the confirmation function is on, the system will confirm the telephone number again. To continue with that number, answer "Yes."

To change the telephone number, answer "No." The system will say "Number please" then say the telephone number again.

8

NOTE

- In the case of English, the system will recognise both "zero" and "oh" (Letter "o") for the number "0."
- The Bluetooth® 2.0 interface supports numbers (0 to 9) and characters (+, # and *).
- The maximum supported telephone number length is as follows:
 - International telephone number: + and telephone numbers (to 18 digits).
 - Except for international telephone number: telephone numbers (to 19 digits).

Making a call using a phonebook

You can make calls using the vehicle phonebook or mobile phonebook of the Bluetooth® 2.0 interface.

For details on the phonebooks, refer to "Phonebook function" on page 8-54.

1. Press the SPEECH button.
2. Say "Call."

NOTE

- If you say "Call" when the vehicle phonebook and the mobile phonebook are empty, the voice guide will say "The vehicle phonebook is empty. Would you like to add a new entry now?"
Answer "Yes," and the voice guide will say "Entering the phonebook - new entry menu." You can now create data in the vehicle phonebook.
Answer "No," the system will return to the main menu.

3. After the voice guide says "Name please," say the name you want to call, from those registered in the phonebook.

4. If there is only 1 match, the system will proceed to Step 5.

If there are 2 or more matches, the voice guide will say "More than one match was found, would you like to call <returned name>." If that person is the one you want to call, answer "Yes."

Answer "No," the name of the next matching person will be uttered by the voice guide.

NOTE

- If you say "No" to all names read by the system, the voice guide will say "Name not found, returning to main menu" and the system will return to the main menu.

Bluetooth® 2.0 interface

5. If only 1 telephone number is registered under the name you just said, the voice guide will proceed to Step 6.

If 2 or more telephone numbers are registered that match the name you just said, the voice guide will say “Would you like to call <name> at [home], [work], [mobile], or [other]?” Select the location to call.

NOTE

- If the name you selected has matching data in the vehicle phonebook but no telephone number is registered under the selected location, the voice guide will say “{home/work/mobile/other} not found for <name>. Would you like to add location or try again?” Say “Try again,” and the system will return to Step 3. Say “Add location” and you can register an additional telephone number under the selected location.
- If the name you selected has matching data in the mobile phonebook but no telephone number is registered under the selected location, the voice guide will say “{home/work/mobile/other} not found for <name>. Would you like to try again?” Answer “Yes,” and the system will return to Step 3. Answer “No,” and the call will be cancelled. Start over again from Step 1.

6. The voice guide will say “Calling <name> <location>” and then the system will dial the telephone number.

NOTE

- When the confirmation function is on, the system will check if the name and location of the receiver are correct. If the name is correct, answer “Yes.” To change the name or location to call, answer “No.” The system will return to Step 3.

Redialing

You can redial the last number called, based on the history of dialed calls in the paired cellular phone.

Use the following procedure to redial.

1. Press the SPEECH button.
2. Say “Redial.”

Send function

During a call, press the SPEECH button to enter voice recognition mode, then say “<numbers> SEND” to generate DTMF tones.

For example, if during a call you need to simulate the pressing of a phone button as a response to an automated system, press the

SPEECH button and speak “1 2 3 4 pound send” and the 1234# will be sent via your cellular phone.

Receiving calls

E00761601064

If an incoming phone call is received while the operation mode is in ON or ACC, the audio system will be automatically turned on and switched to the incoming call, even when the audio system was originally off.

The voice guide announcement for the incoming call will be output from the front passenger’s seat speaker.

If the CD player or radio was playing when the incoming call was received, the audio system will mute the sound from the CD player or radio and output only the incoming call.

To receive the call, press the PICK-UP button on the steering wheel control switch.

When the call is over, the audio system will return to its previous state.

8

Mute function

E00760300041

At any time during a call, you can mute the vehicle microphone.

Pressing the SPEECH button and then saying “Mute” during a call will turn ON the mute function and mute the microphone.

Bluetooth® 2.0 interface

Saying “Mute off” in the same way will turn off the mute function and cancel the mute on the microphone.

Switching between hands-free mode and private mode

E00761400036

The Bluetooth® 2.0 interface can switch between hands-free mode (hands-free calls) and private mode (calls using cellular phone). If you press the SPEECH button and say “Transfer call” during a hands-free call, you can stop the hands-free mode and talk in private mode.

To return to hands-free mode, press the SPEECH button again and say “Transfer call.”

Phonebook function

E00763700017

The Bluetooth® 2.0 interface has 2 types of unique phonebooks that are different from the phonebook stored in the cellular phone. They are the vehicle phonebook and the mobile phonebook.

These phonebooks are used to register telephone numbers and make calls to desired numbers via voice recognition function.

8-54 For pleasant driving

NOTE

- Disconnecting the battery cable will not delete information registered in the phonebook.

Vehicle phonebook

E00763801262

This phonebook is used when making calls with the voice recognition function. Up to 32 names can be registered in the vehicle phonebook per language.

Also, each entry has 4 locations associated with: home, work, mobile and other. You can register one telephone number for each location.

You can register a desired name as a name for any phonebook entry registered in the vehicle phonebook.

Names and telephone numbers can be changed later on.

The vehicle phonebook can be used with all paired cellular phones.

■ To register a telephone number in the vehicle phonebook

You can register a telephone number in the vehicle phonebook in the following 2 ways: Reading out a telephone number, and select-

ing and transferring 1 phonebook entry from the phonebook of the cellular phone.

■ To register by reading out a telephone number

1. Press the SPEECH button.
2. Say “Phonebook.”
3. The voice guide will say “Select one of the following: new entry, edit number, edit name, list names, delete, erase all, or import contact.” Say “New entry.”
4. The voice guide will say “Name please.” Say your preferred name to register it.

NOTE

- If the maximum number of entries are already registered, the voice guide will say “The phonebook is full. Would you like to delete a name?” Say “Yes” if you want to delete a registered name. If you say “No,” the system will return to the main menu.

Bluetooth® 2.0 interface

5. When the name has been registered, the voice guide will say “home, work, mobile, or other?” Say the location for which you want to register a telephone number.

NOTE

- When the confirmation function is on, the voice guide will say “<Location>. Is this correct?” Answer “Yes.”
If a telephone number has been registered for the selected location, the voice guide will say “The current number is <telephone number>, number please.”
If you do not want to change the telephone number, say “cancel” or the original number to keep it registered.

6. The voice guide will say “Number please.” Say the telephone number to register it.

NOTE

- In the case of English, the system will recognise both “zero” and “oh” (Letter “o”) for the number “0.”

7. The voice guide will repeat the telephone number you have just read, and then register the number.

When the telephone number has been registered, the voice guide will say “Number saved. Would you like to add another number for this entry?”

To add another telephone number for a new location for the current entry, answer “Yes.” The system will return to location selection in Step 5.

Answer “No” to end the registration process and return to the main menu.

NOTE

- When the confirmation function is on, after repeating the telephone number you have read, the voice guide will ask “Is this correct?” Answer “Yes.”
Answer “No” to return to telephone number registration in step 6.

■ To select and transfer one phonebook entry from the phonebook of the cellular phone

You can select 1 phonebook entry from the phonebook of the cellular phone and register it in the vehicle phonebook.

NOTE

- Transfer is not permitted unless the vehicle is parked. Before transferring, make sure that the vehicle is parked in a safe location.
- All or part of data may not be transferred, even when the cellular phone supports Bluetooth®, depending on the compatibility of the device.
- The maximum supported telephone number length is 19 digits. Any telephone number of 20 digits or more will be truncated to the first 19 digits.
- If telephone numbers contain characters other than 0 to 9, *, # or +, these characters are deleted before the transfer.
- For the connection settings on the cellular phone side, refer to the instructions for the cellular phone.

1. Press the SPEECH button.
2. Say “Phonebook.”
3. The voice guide will say “Select one of the following: new entry, edit number, edit name, list names, delete, erase all, or import contact.” Say “Import contact.”

Bluetooth® 2.0 interface

4. The voice guide will say “Would you like to import a single entry or all contacts?”
Say “Single entry.”

The Bluetooth® 2.0 interface will become ready to receive transferred phonebook data.

NOTE

- If the maximum number of entries are already registered, the voice guide will say “The phonebook is full. Would you like to delete a name?” Say “Yes” if you want to delete a registered name.
If you say “No,” the system will return to the main menu.

8

5. After the voice guide says “Ready to receive a contact from the phone. Only a home, a work, and a mobile number can be imported,” the Bluetooth® 2.0 interface will receive the phonebook data from the Bluetooth® compatible cellular phone.

6. Operate the Bluetooth® compatible cellular phone to set it up so that the phonebook entry you want to register in the vehicle phonebook can be transferred to the Bluetooth® 2.0 interface.

NOTE

- If the Bluetooth® 2.0 interface cannot recognise the Bluetooth® compatible cellular phone or the connection takes too much time, the voice guide will say “Import contact has timed out” and then the system will cancel the registration. In such case, start over again from Step 1.
- Pressing the HANG-UP button or pressing and holding the SPEECH button will cancel the registration.

7. When the reception is complete, the voice guide will say “<Number of telephone numbers that had been registered in the import source> numbers have been imported. What name would you like to use for these numbers?”
Say the name you want to register for this phonebook entry.

NOTE

- If the entered name is already used for other phonebook entry or similar to a name used for other phonebook entry, that name cannot be registered.

8. The voice guide will say “Adding <name>.”

When the confirmation function is on, the system will ask if the name is correct.
Answer “Yes.”

Answer “No,” the voice guide will say “Name please.” Register a different name.

9. The voice guide will say “Numbers saved.”

10. The voice guide will say “Would you like to import another contact?”

Answer “Yes” if you want to continue with the registration. You can continue to register a new phonebook entry from Step 5.

Answer “No,” the system will return to the main menu.

■ To change the content registered in the vehicle phonebook

E00739800024

You can change or delete a name or telephone number registered in the vehicle phonebook. You can also listen to the list of names registered in the vehicle phonebook.

NOTE

- The system must have at least one entry.

◆ Editing a telephone number

1. Press the SPEECH button.
2. Say "Phonebook."
3. The voice guide will say "Select one of the following: new entry, edit number, edit name, list names, delete, erase all, or import contact". Say "Edit number."
4. The voice guide will say "Please say the name of the entry you would like to edit, or say list names." Say the name of the phonebook entry you want to edit.

NOTE

- Say "List names," and the names registered in the phonebook will be read out in order. Refer to "Vehicle phonebook: Listening to the list of registered names" on page 8-58.

5. The voice guide will say "Home, work, mobile or other?" Select and say the location where the telephone number you want to change or add is registered. When the confirmation function is on, the system will check the target name and location again. Answer "Yes" if you want to continue with the editing. Answer "No," the system will return to Step 3.

6. The voice guide will say "Number, please." Say the telephone number you want to register.

NOTE

- If the telephone number is already registered in the selected location, the voice guide will say "The current number is <current number>. New number, please." Say a new telephone number to change the current number.

7. The voice guide will repeat the telephone number. When the confirmation function is on, the system will ask if the number is correct. Answer "Yes." Answer "No," the system will return to the Step 3.
8. Once the telephone number is registered, the voice guide will say "Number saved" and then the system will return to the main menu.

NOTE

- If the location where a telephone number was already registered has been overwritten with a new number, the voice guide will say "Number changed" and then the system will return to the main menu.

◆ Editing a name

1. Press the SPEECH button.
2. Say "Phonebook."
3. The voice guide will say "Select one of the following: new entry, edit number, edit name, list names, delete, erase all, or import contact." Say "Edit name."
4. The voice guide will say "Please say the name of the entry you would like to edit, or say list names." Say the name you want to edit.

NOTE

- Say "List names," and the names registered in the phonebook are read out in order. Refer to "Vehicle phonebook: Listening to the list of registered names" on page 8-58.

5. The voice guide will say "Changing <name>." When the confirmation function is on, the system will check if the name is correct. Answer "Yes" if you want to continue with the editing based on this information. Answer "No," the system will return to Step 4.
6. The voice guide will say "Name please." Say the new name you want to register.
7. The registered name will be changed. When the change is complete, the system will return to the main menu.

Bluetooth® 2.0 interface

◆ Listening to the list of registered names

E00739900025

1. Press the SPEECH button.
2. Say "Phonebook."
3. The voice guide will say "Select one of the following: new entry, edit number, edit name, list names, delete, erase all, or import contact." Say "List names."
4. Bluetooth® 2.0 interface will read out the entries in the phonebook in order.
5. When the voice guide is done reading the list, it will say "End of list, would you like to start from the beginning?" When you want to check the list again from the beginning, answer "Yes."
When you are done, answer "No" to return to the previous or main menu.

8

NOTE

- You can call, edit or delete a name that is being read out.
Press the SPEECH button and say "Call" to call the name, "Edit name" to edit it, or "Delete" to delete it.
The system will beep and then execute your command.
- If you press the SPEECH button and say "Continue" or "Previous" while the list is being read, the system will advance or rewind the list. Say "Continue" to proceed to the next entry or "Previous" to return to the previous entry.

◆ Deleting a telephone number

E00740000026

1. Press the SPEECH button.
2. Say "Phonebook."
3. The voice guide will say "Select one of the following: new entry, edit number, edit name, list names, delete, erase all, or import contact." Say "Delete."
4. The voice guide will say "Please say the name of the entry you would like to delete, or say list names." Say the name of the phonebook entry in which the telephone number you want to delete is registered.

NOTE

- Say "List names," and the names registered in the phonebook are read out in order. Refer to "Vehicle phonebook: Listening to the list of registered names" on page 8-58.

5. If only one telephone number is registered in the selected phonebook entry, the voice guide will say "Deleting <name> <location>."

If multiple telephone numbers are registered in the selected phonebook entry, the voice guide will say "Would you like to delete [home], [work], [mobile], [other], or all?"

Select the location to delete, and the voice guide will say "Deleting <name> <location>."

NOTE

- To delete the telephone numbers from all locations, say "All."

6. The system will ask if you really want to delete the selected telephone number(s) to go ahead with the deletion, answer "Yes." Answer "No," the system will cancel deleting the telephone number(s) and then return to Step 4.

Bluetooth® 2.0 interface

7. When the telephone number deletion is complete, the voice guide will say “<name> <location> deleted” and then the system will return to the main menu. If all locations are deleted, the system will say “<name> and all locations deleted” and the name will be removed from the phonebook. If numbers still remain under the entry, the name will retain the other associated numbers.

■ Erasing the phonebook

E00740100027

You can delete all registered information from the vehicle phonebook.

1. Press the SPEECH button.
2. Say “Phonebook.”
3. The voice guide will say “Select one of the following: new entry, edit number, edit name, list names, delete, erase all, or import contact.” Say “Erase all.”
4. For confirmation purposes, the voice guide will ask “Are you sure you want to erase everything from your hands-free system phonebook?” Answer “Yes.” Answer “No” to cancel the deletion of all registered information in the phonebook and return to the main menu.

5. The voice guide will say “You are about to delete everything from your hands-free system phonebook. Do you want to continue?” Answer “Yes” to continue. Answer “No” to cancel the deletion of all registered information in the phonebook and return to the main menu.
6. The voice guide will say “Please wait, erasing the hands-free system phonebook” and then the system will delete all data in the phonebook. When the deletion is complete, the voice guide will say “Hands-free system phonebook erased” and then the system will return to the main menu.

Mobile phonebook

E00763900080

All entries in the phonebook stored in the cellular phone can be transferred in a batch and registered in the mobile phonebook. Up to 7 mobile phonebooks, each containing up to 1,000 names, can be registered.

The Bluetooth® 2.0 interface automatically converts from text to voice the names registered in the transferred phonebook entries, and creates names.

NOTE

- Only the mobile phonebook transferred from the connected cellular phone can be used with that cellular phone.
- You cannot change the names and telephone numbers in the phonebook entries registered in the mobile phonebook. You cannot select and delete specific phonebook entries, either. To change or delete any of the above, change the applicable information in the source phonebook of the cellular phone and then transfer the phonebook again.

To import a devices phonebook

8

Follow the steps below to transfer to the mobile phonebook the phonebook stored in the cellular phone.

NOTE

- Transfer should be completed while the vehicle is parked. Before transferring, make sure that the vehicle is parked in a safe location.
- The already stored phonebook in the mobile phonebook is overwritten by the stored phonebook in the cellular phone.
- All or part of data may not be transferred, even when the cellular phone supports Bluetooth®, depending on the compatibility of the device.
- Only a home, a work, and a mobile number can be imported.

Bluetooth® 2.0 interface

NOTE

- The maximum supported telephone number length is 19 digits. Any telephone number of 20 digits or more will be truncated to the first 19 digits.
- If telephone numbers contain characters other than 0 to 9, *, # or +, these characters are deleted before the transfer.
- For the connection settings on the cellular phone side, refer to the instructions for the cellular phone.

8

1. Press the SPEECH button.
2. Say "Phonebook."
3. The voice guide will say "Select one of the following: new entry, edit number, edit name, list names, delete, erase all, or import contact." Say "Import contact."
4. The voice guide will say "Would you like to import a single entry or all contacts?" Say "All contacts."

5. The voice guide will say "Importing the contact list from the mobile phonebook. This may take several minutes to complete. Would you like to continue?" Answer "Yes," transferring to the mobile phonebook the phonebook stored in the cellular phone will start. Answer "No," the system will return to the main menu.

NOTE

- The transfer may take some time to complete depending on the number of contacts.
- If the Bluetooth® 2.0 interface could not be connected to the Bluetooth® compatible cellular phone, the voice guide will say "Unable to transfer contact list from phone" and then the system will return to the main menu.
- If you press the HANG-UP button or press and hold the SPEECH button during the data transfer, the transfer will be cancelled and the system will return to the main menu.
- If an error occurs during the data transfer, all transfer will be cancelled and the voice guide will say "Unable to complete the phonebook import" and then the system will return to the main menu.
- If there are no contacts in the phonebook, the voice guide will say "There are no contacts on the connected phone."

6. When the transfer is complete, the voice guide will say "Import complete" and then the system will return to the main menu.

USB input terminal

Enrollment commands

E00732400249

Phrase	English	French	Spanish	Italian	German	Dutch	Portuguese	Russian
1	123456789	123456789	123456789	123456789	123456789	123456789	123456789	123456789
2	888 555 1212	888 555 1212	888 555 1212	888 555 1212	888 555 1212	888 555 1212	888 555 1212	888 555 1212
3	Call	Appeler	Llamar	Chiama	Anrufen	Bellen	Ligar	Вызов
4	Dial	Composer	Marcar	Componi	Wählen	Nummer keuze	Marcar	Набор
5	Setup	Configurer	Configuración	Configura	Einrichtung	Setup	Configurar	Настройка
6	Cancel	Annuler	Cancelar	Annulla	Abbrechen	Annuleren	Cancelar	Отмена
7	Continue	Continuer	Continuar	Continua	Weiter	Doorgaan	Continuar	Продолжить
8	Help	Aide	Ayuda	Aiuto	Hilfe	Help	Ajuda	Справка

8**USB input terminal**

E00761901126

You can connect your USB memory device or iPod* to play music files stored in the USB memory device or iPod.

The following explains how to connect and remove a USB memory device or iPod.

*: "iPod" is a registered trademark of Apple Inc. in the United States and other countries.

How to connect a USB memory device

E00762001401

1. Park your vehicle in a safe place and put the operation mode in OFF.

2. Open the USB input terminal cover (A) in the floor console box.

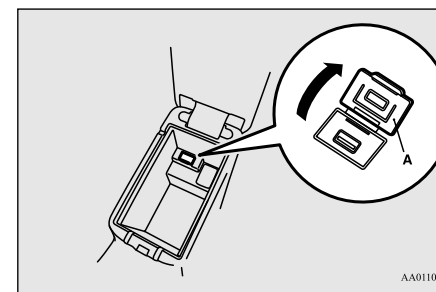

AA0110493

For pleasant driving 8-61

USB input terminal

3. Connect a commercially available USB connector cable (C) to the USB memory device (B).

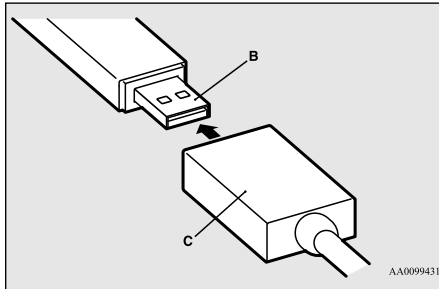

8

4. Connect the USB connector cable (C) to the USB input terminal (D).

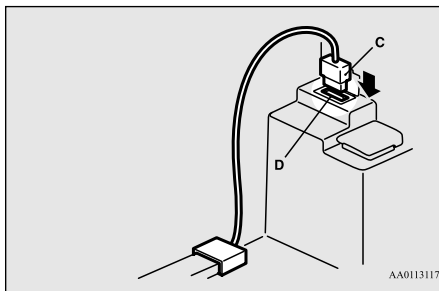

CAUTION

- Keep the lid of the floor console box closed while driving the vehicle. A lid or the contents of the floor console box could otherwise cause injuries.

NOTE

- Do not connect the USB memory device to the USB input terminal directly. The USB memory device may be damaged.
- When closing the floor console box, be careful not to trap the USB connector cable.

5. To remove the USB connector cable, put the operation mode in OFF first and perform the installation steps in reverse.

How to connect an iPod

E00762101301

1. Park your vehicle in a safe place and put the operation mode in OFF.

2. Open the USB input terminal cover (A) in the floor console box.

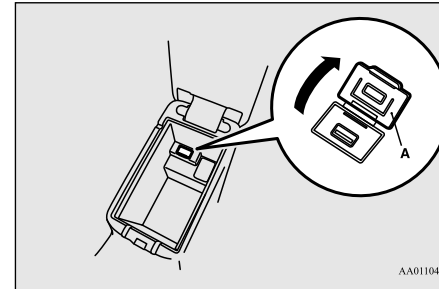

3. Connect the Dock connector (C) to the iPod (B).

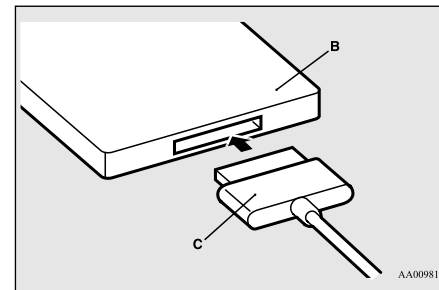

NOTE

- Use a genuine Dock connector from Apple Inc.

4. Connect the Dock connector (C) to the USB input terminal (D).

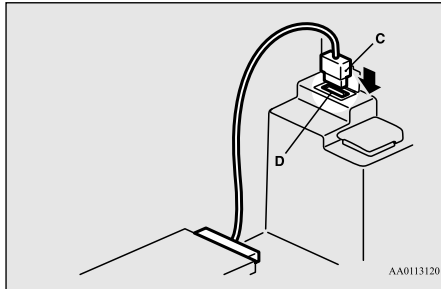

CAUTION

- Keep the lid of the floor console box closed while driving the vehicle. A lid or the contents of the floor console box could otherwise cause injuries.

NOTE

- When closing the floor console box, be careful not to trap the connector cable.

5. To remove the Dock connector, put the operation mode in OFF first and perform the installation steps in reverse.

Types of connectable devices and supported file specifications

E00762200015

Device types

E00762301361

Devices of the following types can be connected.

Model name		Condition
USB memory device		Storage capacity of 256 Mbytes or more
iPod*	fifth generation	F/W Ver.1.3 or later
iPod classic*	80GB/180GB	F/W Ver.1.1.2 or later
	120GB	F/W Ver.2.0.1 or later
	160GB (late 2009)	F/W Ver.2.0.4 or later

USB input terminal

Model name		Condition
iPod nano*	first generation	F/W Ver.1.3.1 or later
	second generation	F/W Ver.1.1.3 or later
	third generation	F/W Ver.1.1.3 or later
	fourth generation	F/W Ver.1.0.4 or later
	fifth generation	F/W Ver.1.0.2 or later
	sixth generation	F/W Ver.1.0 or later
iPod touch*	first generation	F/W Ver.3.1.3 or later
	second generation	F/W Ver.4.2.1 or later
	third generation	F/W Ver.4.3.1 or later
	fourth generation	F/W Ver.4.3.1 or later

8

Sun visors

Model name	Condition	
iPhone*	iPhone	F/W Ver.3.1.3 or later
	iPhone 3G	F/W Ver.4.2.1 or later
	iPhone 3GS	F/W Ver.4.3.1 or later
	iPhone 4	F/W Ver.4.3.1 or later
	iPhone 4S	F/W Ver.5.0.1 or later
Models other than USB memory devices and iPods	Digital audio player supporting mass storage class	

8

*: "iPod," "iPod classic," "iPod nano," "iPod touch" and "iPhone" are registered trademarks of Apple Inc. in the United States and other countries.

NOTE

- Depending on the type of the USB memory device or other device connected, the connected device may not function properly or the available functions may be limited.
- It is recommended to use an iPod with firmware updated to the latest version.
- You can charge your iPod by connecting it to the USB input terminal when the operation mode is in ON or ACC.

NOTE

- Do not keep your USB memory device or iPod in your vehicle.
- It is recommended that you back up the files in case of data damage.
- Do not connect to the USB input terminal any device (hard disk, card reader, memory reader, etc.) other than the connectable devices specified in the previous section. The device and/or data may be damaged. If any of these devices was connected by mistake, remove it after putting the operation mode in OFF.

File specifications

E00762400033

You can play music files of the following specifications that are saved in a USB memory device or other device supporting mass storage class. When you connect your iPod, playable file specifications depend on the connected iPod.

Item	Condition
File format	MP3, WMA, AAC
Maximum number of levels (including the root)	Level 8
Number of folders	700
Number of files	65,535

Sun visors

E00711202277

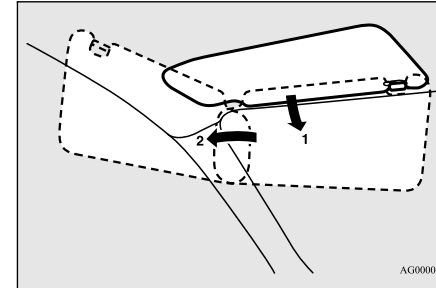

- 1- To eliminate front glare
- 2- To eliminate side glare

AG0000309

Vanity mirror

A vanity mirror is fitted to the back of the sun visor.

Operating the lid of the vanity mirror will automatically turn on the mirror lamp (A).

Ashtray

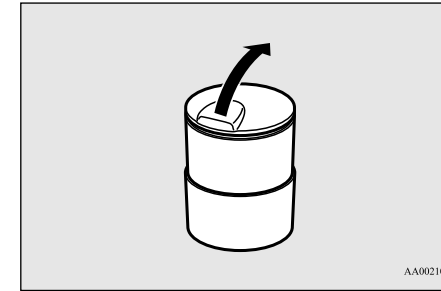
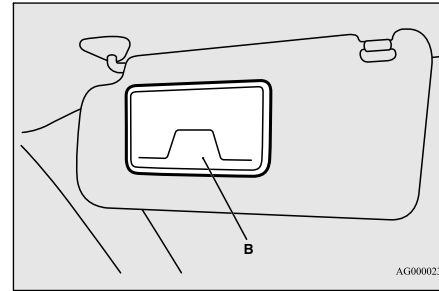
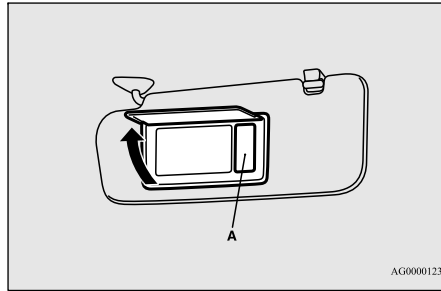

CAUTION

- If the lid of vanity mirror with lamp is kept open for prolonged periods of time, the auxiliary battery will be discharged.

Card holder

Cards can be slipped into the holder (B) on the back of the sunvisor.

Ashtray

E00711402165

CAUTION

- Put out matches and cigarettes before they are placed in the ashtray.
- Don't put papers and other things that burn into your ashtrays. If you do, cigarettes or other smoking materials could set them on fire, causing damage.
- Always close the ashtray. If left open, other cigarette butts in the ashtray may be rekindled.

To use the ashtray, open the lid.

Mounting position for moveable ashtray

8

The moveable ashtray can be fitted at the indicated position.

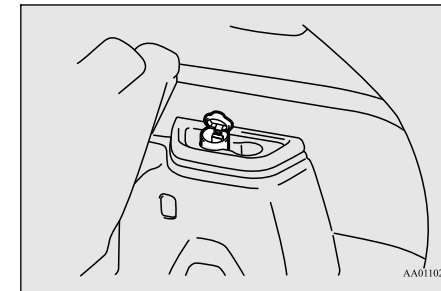

Accessory socket

Accessory socket

E00711602516

CAUTION

- Be sure to use a “plug-in” type accessory operating at 12 V and at 120 W or less. When using more than one socket at the same time, make sure that the electrical accessories are 12 V accessories and that the total power consumption does not exceed 120 W.
- Long use of the electric appliance when the ready indicator is not illuminated may run down the auxiliary battery.
- When the accessory socket is not in use, be sure to close the lid or install the cap, because the socket might become clogged by foreign material and be short-circuited.

8

To use a plug-in type accessory, open the lid or remove the cap, and insert the plug in the accessory socket.

NOTE

- Accessory sockets in 2 locations can be used at the same time.

The accessory socket can be used while the operation mode is in ON or ACC.

Floor console

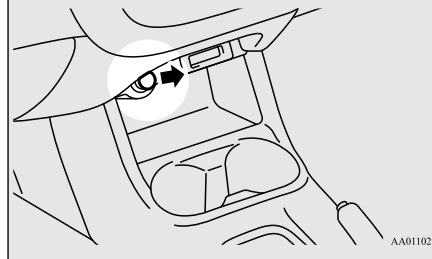

Floor console box

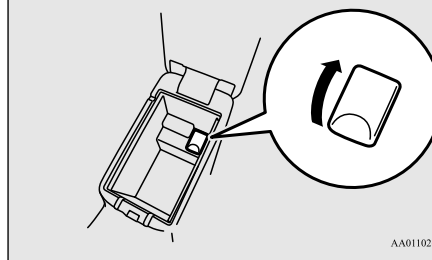

Interior lamps

E00712002328

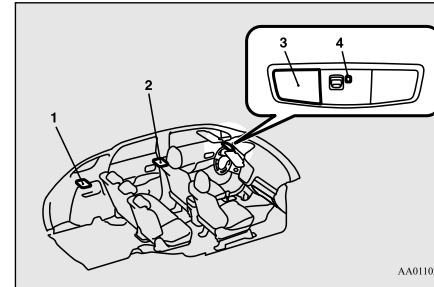

- 1- Luggage room lamp
- 2- Room lamp (rear)
- 3- Map & room lamps (front)
- 4- Downlight → P.6-40

NOTE

- If you leave the lamps on when the ready indicator is not illuminated, you will run down the auxiliary battery. Before you leave the vehicle, make sure the lamps are turned off.



Interior lamps

Room lamps

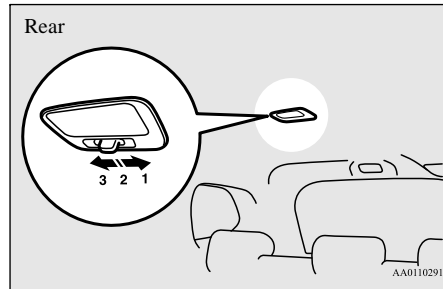
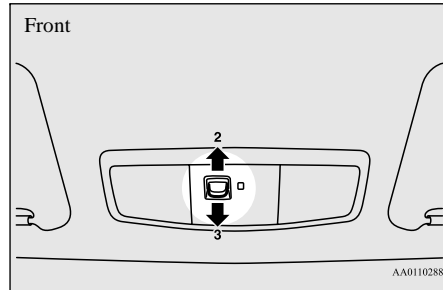
E00712102404



Position of lamp switch	On/off control
1-ON ()	The lamp illuminates regardless of whether a door or the tailgate is open or closed.

Position of lamp switch	On/off control
2-DOOR ()	The lamp illuminates when a door or the tailgate is opened. It goes off about 15 seconds after all doors and the tailgate are closed. However, the lamp goes off immediately with all doors and the tailgate closed in the following cases:
	• When the operation mode is put in ON.
	• When the central door lock function is used to lock the vehicle.
	• When the keyless operation key is used to lock the vehicle.
3-OFF ()	• When the keyless operation function is used to lock the vehicle.
	The lamp goes off regardless of whether a door or the tailgate is open or closed.

NOTE

- When the operation mode is put in OFF while the doors and tailgate are closed, the lamp illuminates and after about 15 seconds it goes off.
- The time until the lamp goes off can be adjusted. For details, please consult a MITSUBISHI MOTORS Authorised Service Point. On vehicles equipped with Mitsubishi Multi-Communication System (MMCS), screen operations can be used to make the adjustment. Refer to the separate owner's manual for details.

8

Map lamps

E00712400168

Push the lens (A) to turn on the lamp. Push it again to turn it off.

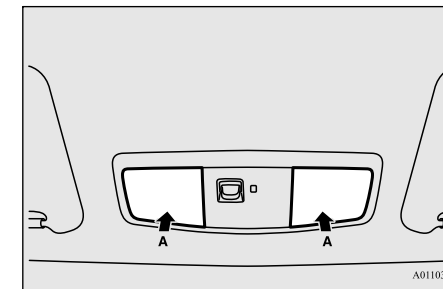

Storage spaces

Luggage room lamp

E00712700709

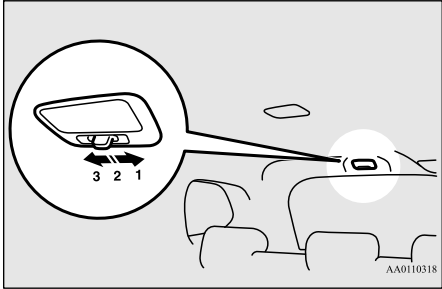

8

1- (☒)

The lamp illuminates regardless of whether the tailgate is open or closed.

2- (●)

The lamp illuminates when the tailgate is opened, and goes off when the tailgate is closed.

3- (○)

The lamp goes off regardless of whether the tailgate is open or closed.

Lamps (room lamps, etc.) auto-cutout function

E00712902385

If any of the interior lamps are left switched on with the operation mode in OFF, it goes

off automatically after approximately 30 minutes.

The lamps will illuminate again after they automatically go off if the power switch is operated, if one of the doors or the tailgate is opened or closed, or if the keyless entry system or keyless operation system is operated.

NOTE

- The interior lamp auto-cut function can be deactivated. The time until the lamps automatically go off can be adjusted. For details and support, consult your nearest MITSUBISHI MOTORS Authorised Service Point. On vehicles equipped with Mitsubishi Multi-Communication System (MMCS), screen operations can be used to make the adjustment. Refer to the separate owner's manual for details.

Storage spaces

E00713103046

WARNING

- Do not carry fuel-filled containers or spray cans inside your vehicle. Leaving fuel-filled containers or spray cans in your vehicle could cause the containers to burst or an explosion of evaporated gas.

CAUTION

- Never leave lighters, canned carbonated beverage, and spectacles in the cabin when parking the vehicle in hot sunshine. The cabin will become extremely hot, so lighters and other flammable items may catch fire and unopened drink cans may rupture. Also, spectacles with plastic lenses or materials could deform or crack.
- Keep the lids on storage spaces closed while driving the vehicle. A lid or the contents of a storage space could otherwise cause injuries.

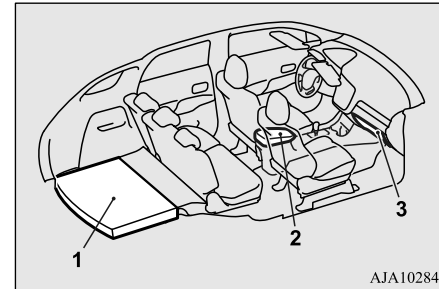

- 1- Luggage floor box
- 2- Floor console box
- 3- Glove box

Glove box

E00726200268

To open, pull the lever (A).

Storage spaces

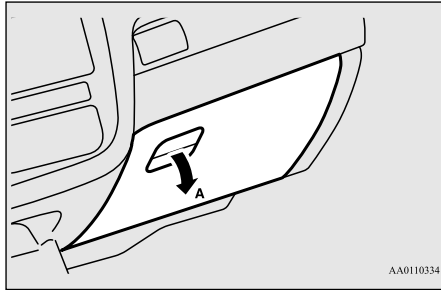

AA0110334

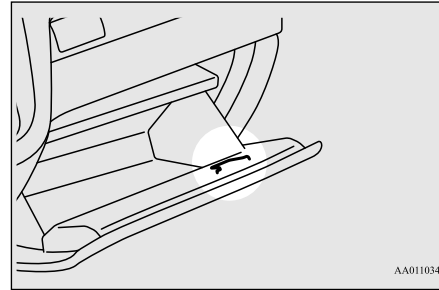

AA0110347

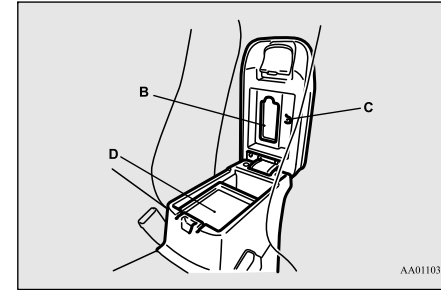

AA0110363

- B- Tissue holder
- C- Pen holder
- D- Tray

NOTE

- When the lamps are illuminated with the lamp switch in the “”, “”, or “AUTO” position (vehicles with automatic lamp control), the glove box lamp illuminates.

Floor console box

E00723302031

To open the console box, lift the release lever (A) and raise the lid.
The floor console box can also be used as an armrest.

NOTE

- The USB input terminal is located in the floor console box. For details, refer to “USB input terminal” on page 8-61.

8

Card holder

There is a card holder inside the glove box.

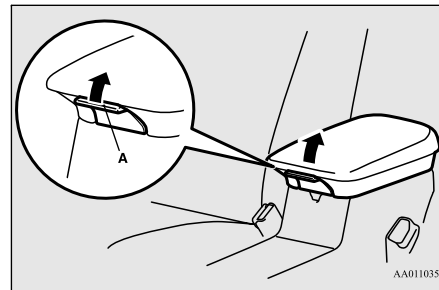

AA0110350

Luggage floor box

E00718701795

The box for storing articles is located inside the luggage compartment.
To use the box, raise the luggage floor board (A).

Cup holder

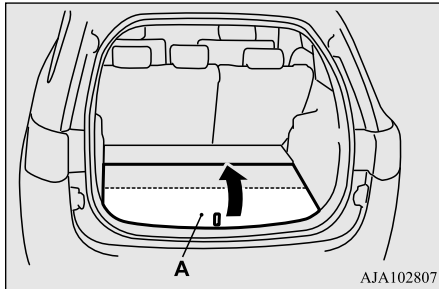

8

To use the luggage floor box in the rear seat side, insert your hand in the gap (B) and raise the board (A) to the seat side.

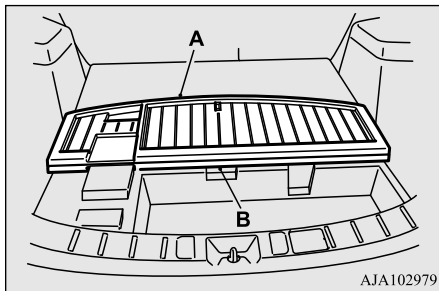

⚠ WARNING

- Do not place any object around the “” mark, since there is the auxiliary battery under the luggage floor box. If the battery cover is broken, a battery fluid may leak. If it adheres to your skin or gets in your eyes, serious injury may result.

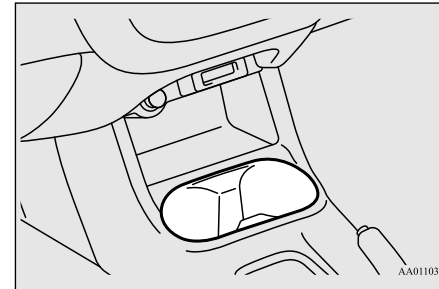
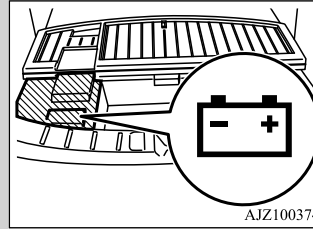

For the rear seat

E00716901562

In order to use the cup holder, allow the armrest to drop down.

Cup holder

E00714501043

⚠ CAUTION

- Do not drink beverages while driving. This is distracting and could cause an accident.

For the front seat

The cup holder is located in front of the floor console.

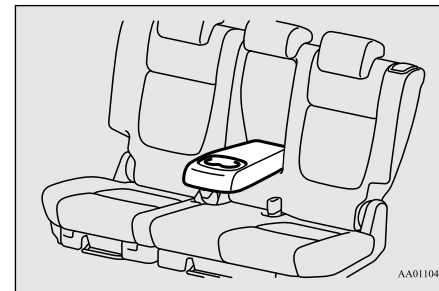

Bottle holder

Bottle holder

E00718200360

CAUTION

- Do not drink beverages while driving. This is distracting and could cause an accident.
- Drinks could be spilled by the vibration and jolts while driving. If the spilt drink is very hot, you could be burnt.

There are bottle holders located on both sides of front and rear doors.

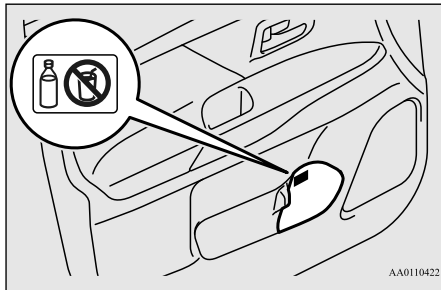

NOTE

- Do not store cup or drink can in the bottle holder.
- Tightly close the cap on drink bottles before storing them.
- Some bottles may be too big or the wrong shape to fit in the holder.

Cargo area cover

E00733601085

To use

1. Draw out the cover retracted by spring and insert it in the mounting grooves (A).

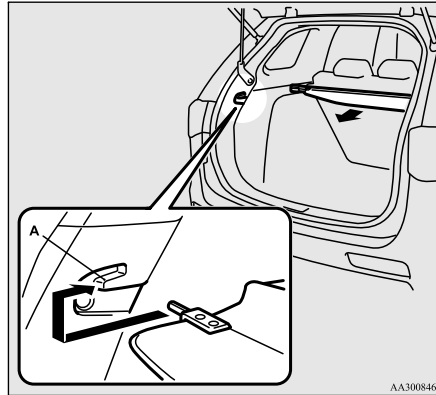

2. Remove the cover from the mounting grooves, and the cover will be rolled back into the retracted position.

NOTE

- Do not put luggage on the cover.

To change position

There are two installation holes (B) for the cover.

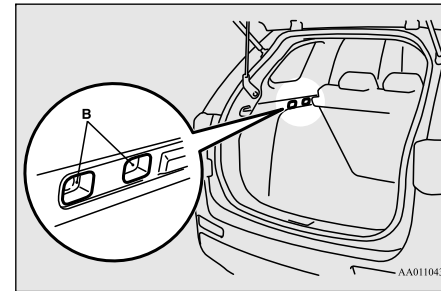

1. Move one of the sliders (C) toward the inside of the vehicle, and fit the tab (D) into the installation hole that is to be used. Move the opposite slider in the same fashion.

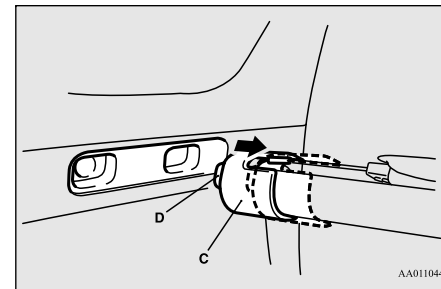

8

Assist grips

2. After changing the position, gently shake the entire cover to make sure it is securely retained.

NOTE

- If the rear seatback touches the cover, move the cover rearward. The cover could break if it supports the seatback of the rear seat.

To remove

8

1. Roll the cover into the retracted position.
2. Move one of the sliders (C) toward the inside of the vehicle and lift it to remove the cover.

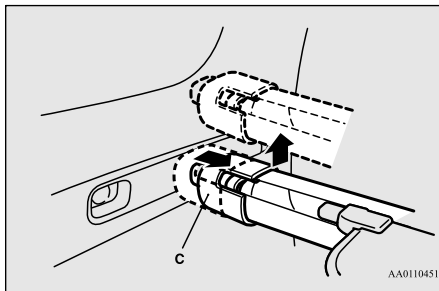

To refit

Refit the cover by performing the removal steps in reverse. Gently shake the entire cover after fitting it to make sure it is securely retained.

Assist grips

E00732800298

The assist grips (located above the doors on the headliner) are not designed to support body weight. They are intended for use only while seated in the vehicle.

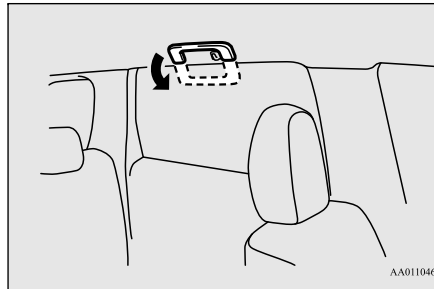

CAUTION

- Do not use the assist grips when getting into or out of the vehicle. The assist grips could detach causing you to fall.

Coat hook

E00725601640

There is a coat hook on the rear seat assist grip of the driver's side.

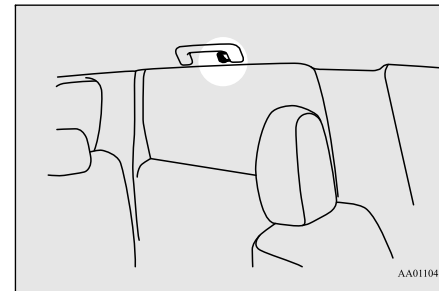

WARNING

- Do not put a hanger or any heavy or pointed object on the coat hook. If the curtain airbag was activated, any such item could be propelled away with great force and could prevent the curtain airbag from inflating correctly. Hang clothes directly on the coat hook (without using a hanger). Make sure there are no heavy or sharp objects in the pockets of clothes that you hang on the coat hook.

Luggage hooks

E00715700579

There are 4 hooks located on the side walls of the luggage compartment. Use the hooks for securing the luggage.

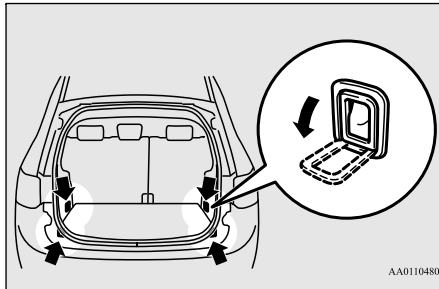

⚠ CAUTION

- Do not pile up the luggage beyond the seat-back height. Also, firmly secure the luggage. Otherwise, serious accidents could result due to hindered rearward view or flying objects during sudden braking.

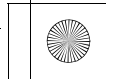
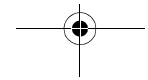
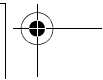
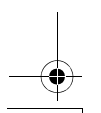
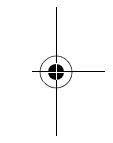
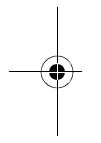
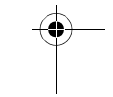
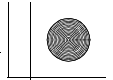
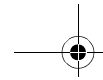
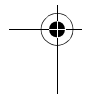
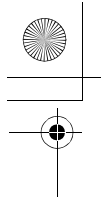



For emergencies

If the vehicle breaks down.....	9-2
Emergency starting	9-2
Engine overheating	9-4
Tools and jack	9-6
Tyre repair kit	9-7
How to change a tyre	9-14
Towing	9-19
Operation under adverse driving conditions.....	9-22

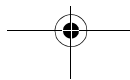
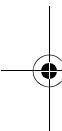

If the vehicle breaks down

If the vehicle breaks down

E00800102378

If the vehicle breaks down on the road, move it to the shoulder and use the hazard warning flashers and/or the warning triangle etc. Refer to “Hazard warning flasher switch” on page 6-45.

WARNING

- If you are unable to safely assess the vehicle due to vehicle damage, do not touch the vehicle. Leave the vehicle and contact emergency services. Advise emergency responders that this is a Plug-in Hybrid Electric vehicle.

9

If the ready indicator goes out while driving

Vehicle operation and control are affected if the ready indicator goes out while driving. Before moving the vehicle to a safe area, be aware of the following:

- The brake booster may become inoperative and the pedal effort will increase. Press down the brake pedal harder than usual.

9-2 For emergencies

- The power steering system may not operate, the steering wheel feels heavy when turning it.

Emergency starting

E00800503920

If the Plug-in Hybrid EV system cannot be started because the auxiliary battery is weak or dead, the battery from another vehicle can be used with jumper cables to start the Plug-in Hybrid EV system.

WARNING

- To start the Plug-in Hybrid EV system using jumper cables from another vehicle, perform the correct procedures according to the instruction below. Incorrect procedures could result in a fire, explosion, electric shock or damage to the vehicles.
- Keep sparks, cigarettes and flames away from the battery because the battery may produce an explosion.

CAUTION

- The Plug-in Hybrid EV system cannot be started by pulling or pushing the vehicle.
- Check the other vehicle. It must have a 12-volt battery. If the other system isn't 12-volt, shorting can damage both vehicles.
- Use the proper cables suitable for the battery size to prevent overheating of the cables.

CAUTION

- Check the jumper cables for damage and corrosion before use.
- Always wear protective eye goggles when working near the battery.
- Keep the battery out of the reach of children.
- Do not attempt jump starting the auxiliary battery while the drive battery is being charged. Doing so could damage the vehicle or charging equipment.

NOTE

- If the auxiliary battery is disconnected, the operation mode of the power switch is memorized. When a booster battery is connected by jumper cables, the operation mode returns to the state before the auxiliary battery run down. Pay due attention if you do not know the operation mode before the auxiliary battery was fully discharged.
- If the auxiliary battery is fully discharged with the select position in the “P” (PARK) position, the select position cannot be changed to other position from the “P” (PARK) position in some cases. In such a case, the front wheels have been locked. Therefore, the vehicle cannot be moved.

1. Get the vehicles close enough so the jumper cables can reach, but be sure the vehicles aren't touching each other.

Emergency starting

- Turn off all lamps, heater and other electrical loads.
- Set the parking brake firmly on each vehicle. Set the gear of another vehicle in "P" (PARK) position (with A/T) or in "N" (Neutral) position (with M/T) and stop the engine.

⚠ WARNING

- When connecting the jumper cable, stop the engine in another vehicle. Otherwise, the cables or your clothes may be caught by the fan or drive belt and personal injury could result.
- The cooling fan turns on and off depending on the coolant temperature. Do not bring your hands close to the fan while the engine is running or Plug-in Hybrid EV System is operating.

- Open the bonnet, remove the fuse cover of the main fuse block.
Refer to "Bonnet" on page 11-3 and "Fuses: Engine compartment" on page 11-16.

- Open the cover of the jumper cable terminal in the main fuse block.

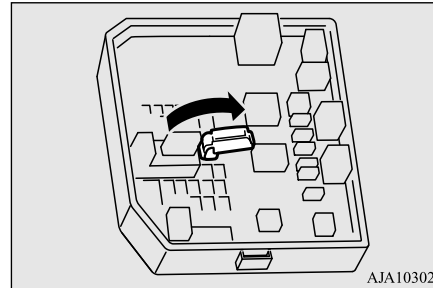

📖 NOTE

- You cannot rescue other vehicle's discharged battery by connecting jumper cables using this jumper cable terminal.

- Connect one end of one jumper cable ① to the jumper cable terminal (A) of your vehicle, and the other end ② to the positive (+) terminal of the booster battery (B).
- Connect one end of the other jumper cable ③ to the negative (-) terminal of the booster battery, and the other end ④ to the designated ground location of your vehicle.

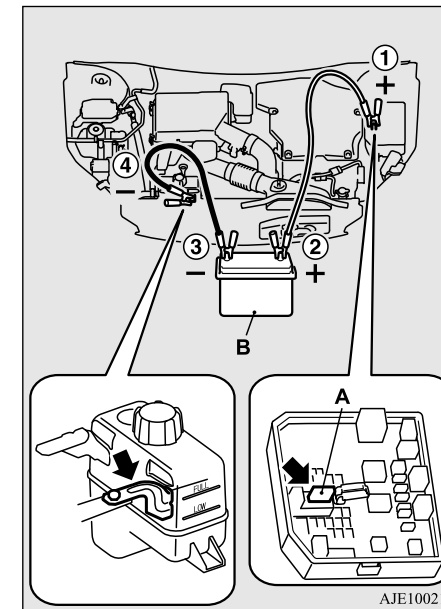

Engine overheating

WARNING

- When connecting the jumper cables, do not connect the positive (+) cable to the negative (-) terminal. Otherwise sparks might cause explosion of the battery.

CAUTION

- Use care not to get the jumper cable caught in the cooling fan or other rotating part in the engine compartment.

NOTE

- If the jumper cable is connected to the any position other than appointed position, it may could cause damage to the vehicle.

- 9
7. Start the engine in the vehicle which has the booster battery, let the engine idle a few minutes, then start the Plug-in Hybrid EV system in your vehicle.
 8. Check that the ready indicator illuminates. If the ready indicator does not illuminate, contact a MITSUBISHI MOTORS Authorised Service Point.
 9. When the ready indicator illuminates, disconnect the jumper cables in the reverse order of connection.

9-4 For emergencies

10. Check that the select position can be shifted to all positions other than the “P” (PARK) position.
11. Have the auxiliary battery inspected by your nearest MITSUBISHI MOTORS Authorised Service Point.

CAUTION

- Your vehicle is equipped with an exclusive auxiliary battery. Even if the battery type is the same, the battery may not be correctly installed in your vehicle. When replacing the auxiliary battery, request a MITSUBISHI MOTORS Authorised Service Point to do so.

Engine overheating

E00800603745

When the engine is overheating, the information screen in the multi information display will be interrupted and the engine coolant temperature warning display will appear.

If this occurs, take the following corrective measures:

1. Stop the vehicle in a safe place.

2. Check whether steam is coming from the engine compartment.

[If steam does not come from the engine compartment]
With the Plug-in Hybrid EV system still starting, raise the bonnet to ventilate the engine compartment.

[If steam is coming from the engine compartment]
Stop the Plug-in Hybrid EV system, and when the steam stops, raise the bonnet to ventilate the engine compartment. Restart the Plug-in Hybrid EV system.

WARNING

- Do not open the bonnet while steam is coming from the engine compartment. It could cause steam or hot water to spurt out, causing burns. Hot water could spurt out even when there is no steam coming out, and some parts will be very hot. Be very careful when opening the bonnet.
- Be careful of hot steam, which could be blowing off the reserve tank cap.
- Do not attempt to remove the radiator cap while the engine is hot.

Engine overheating

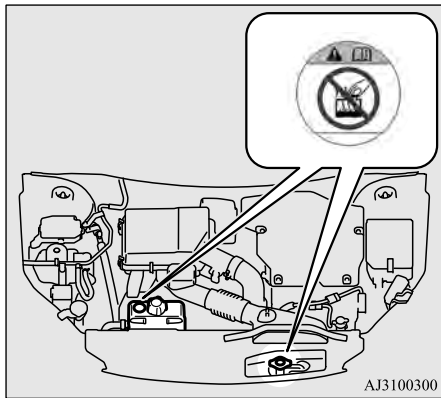

3. Confirm that the cooling fans (A) are turning.

[If the cooling fans are turning]

After the high coolant temperature warning has gone off, stop the Plug-in Hybrid EV system.

[If the cooling fans are not turning]

Stop the Plug-in Hybrid EV SYSTEM immediately and contact a MITSUBISHI MOTORS Authorised Service Point for assistance.

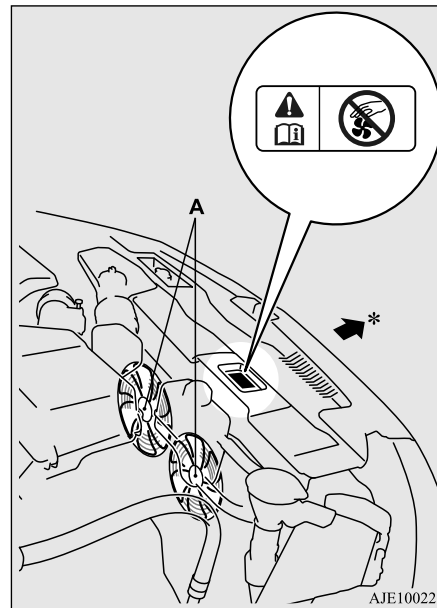

*: Front of the vehicle

WARNING

- Be careful not to get your hands or clothes caught in the cooling fan.

4. Check the coolant level in the reserve tank (B and C).

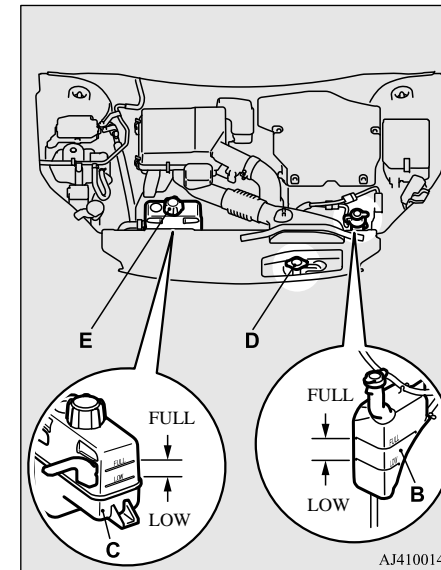

B: Reserve tank for engine cooling

C: Reserve tank for EV cooling system

Tools and jack

5. Add coolant to the radiator and/or reserve tank if necessary. (Refer to the “Maintenance” section.)

⚠ WARNING

- Make sure that the engine and the Plug-in Hybrid EV system have cooled down before removing the radiator cap (D) and the reserve tank cap (E), because hot steam or boiling water otherwise will gush from the filler port and may scald you.

⚠ CAUTION

- Do not add coolant while the engine is hot. Suddenly adding cold coolant could damage the engine. Wait for the engine to cool down, then add coolant a little at a time.

9

6. Examine the radiator hoses for coolant leakage and the drive belt for looseness or damage.
If there is anything wrong with the cooling system or drive belt, we recommend you to have it checked and repaired.

Tools and jack

E00800902507

Storage

The tools are stowed on the right side of the luggage area.
The jack is stowed in the luggage floor box.
The storage location of the tools and jack should be remembered in case of an emergency.

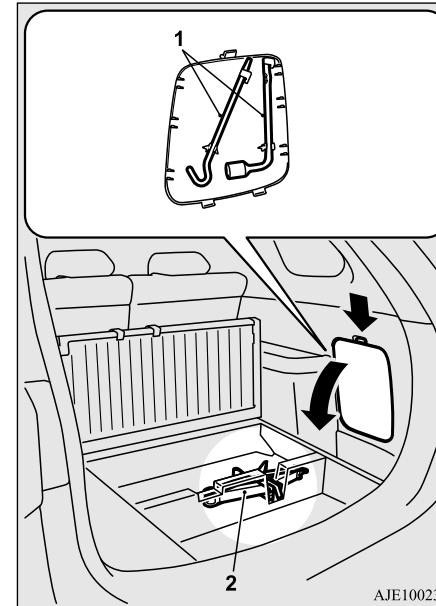

- 1- Tools
- 2- Jack

Tyre repair kit

Tools

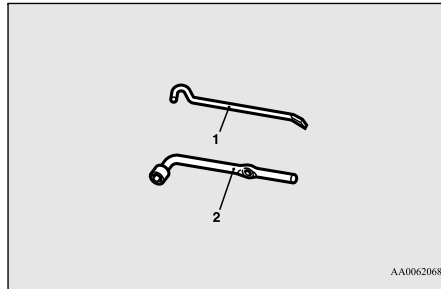

- 1- Jack bar
- 2- Wheel nut wrench

AA0062068

2. Remove the band (A) and take out the jack.

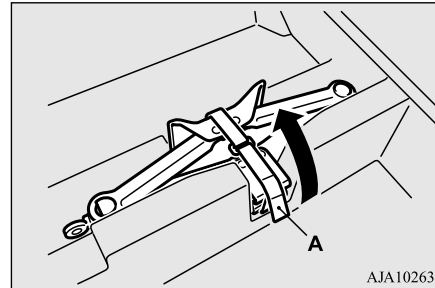

AJA102634

To store

Perform the removal steps in reverse.

Tyre repair kit

E00804501038

This kit enables emergency repair of a small puncture in the tread area of a tyre that has run over a nail, screw, or similar object.

Storage

The tyre repair kit is stored beneath the luggage floor board of the luggage compartment.

The storage location of the tyre repair kit should be remembered in case of an emergency.

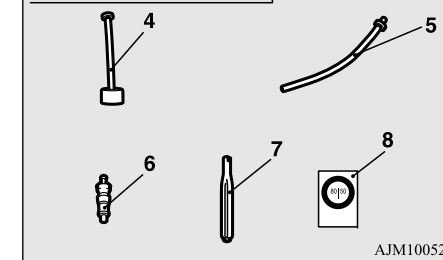
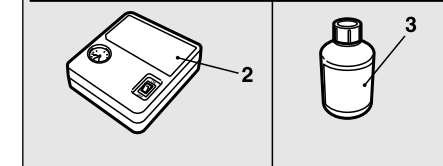
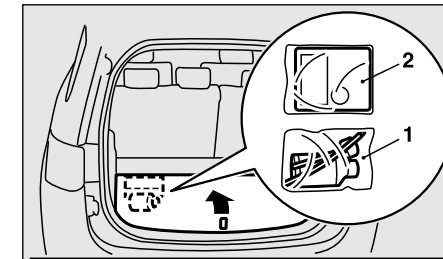

AJM100520

- 1- Tyre repair set
- 2- Tyre compressor
- 3- Tyre sealant bottle
- 4- Filler hose

For emergencies 9-7

Tyre repair kit

- 5- Extension hose (This hose is used for removal of sealant. It is not used in emergency puncture repair.)
- 6- Valve insert (spare)
- 7- Valve remover
- 8- Speed restriction sticker

How to use the tyre repair kit

E00804601026

CAUTION

- The tyre sealant can cause health damage if swallowed. If you accidentally swallow it, drink as much water as possible and immediately have yourself examined by a doctor.
- If the tyre sealant gets in your eyes or on your skin, rinse it away with lots of water. If you still sense an abnormality, have yourself examined by a doctor.
- Consult a doctor immediately if any allergic reactions occur.
- Be careful not to allow children to touch the tyre sealant.
- Do not breathe in the vapours of tyre sealant.
- Be sure to use a MITSUBISHI MOTORS GENUINE tyre sealant.

9

9-8 For emergencies

NOTE

- The tyre sealant cannot be used in any of the situations listed below. If any of these situations occurs, please contact a MITSUBISHI MOTORS Authorised Service Point or another specialist.
- The tyre sealant's expiry date has passed. (The expiry date is shown on the bottle label.)

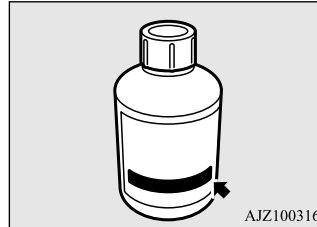

- More than one tyre is punctured.
- The puncture hole has a length or width of 4 mm or more.
- The tyre is punctured in the side wall (A), not in the tread (B).

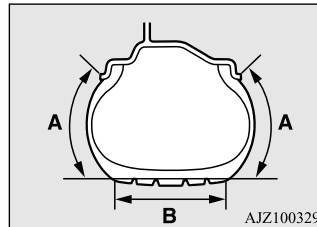

- The vehicle has been driven with the tyre almost completely flat.

NOTE

- The tyre has completely slipped over the wheel rim and come off the wheel.
- The wheel is damaged.
- Use the tyre sealant only at ambient temperatures of -30 °C to + 60 °C.
- Effect an emergency repair without pulling out the object (nail, screw, etc.) that is stuck in the tyre.
- Do not use the tyre sealant if the tyre has been damaged by being driven when insufficiently inflated (e.g. bumps, cuts, cracks etc. on the tyre).
- Wipe tyre sealant off the paintwork immediately with a damp cloth.
- Immediately wash clothes contaminated with tyre sealant.

Before repairing a tyre, first stop your vehicle in a safe, flat location.

1. Park the vehicle on level and stable ground.
2. Set the parking brake firmly.
3. Put the select position in "P" (PARK) position and stop the Plug-in Hybrid EV system.
4. Turn on the hazard flashers and set up a warning triangle, flashing signal lamp, etc., at an adequate distance from the vehicle, and have all your passengers leave the vehicle.
5. Take out the tyre repair kit.

Tyre repair kit

6. Shake the tyre sealant bottle well.

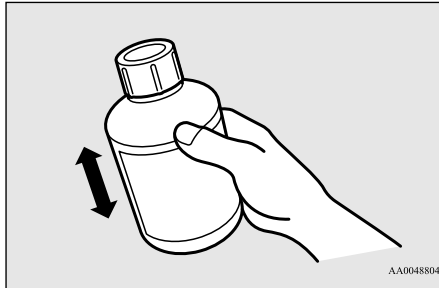

NOTE

- In cold conditions (when the ambient temperature is 0 °C or lower), thickening of the tyre sealant can make the tyre sealant hard to squeeze out of the bottle. Warm the bottle inside the vehicle.

7. Take the cap (C) off the tyre sealant bottle (D). Do not remove the seal (E). Screw the filler hose (F) onto the bottle (D). As you screw the filler hose onto the bottle, the seal will break, allowing the sealant to be used.

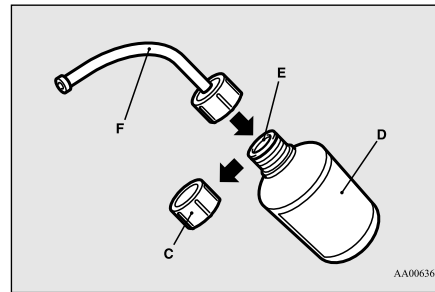

CAUTION

- If you shake the bottle after screwing on the hose, sealant may spray out of the hose.

8. Take the valve cap (G) off the tyre valve (H), then press the valve remover (I) onto the valve as illustrated. Allow all of the air in the tyre to escape.

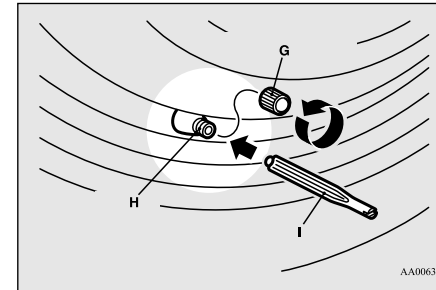

9. Remove the valve insert (J) by turning it anticlockwise using the valve remover (I). Put the removed valve insert in a clean place so it does not get dirty.

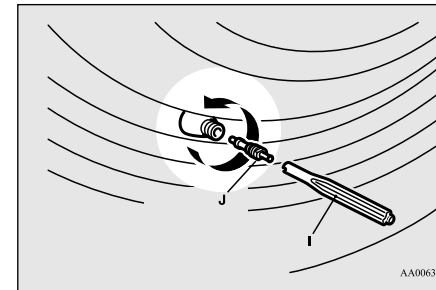

Tyre repair kit

⚠ CAUTION

- If there is any air left in the tyre when you remove the valve insert, the valve insert may fly out and injure you. Make sure the tyre contains no air before removing the valve insert.

10. Remove the plug (K) from the free end of the hose (L). Press the hose onto the valve (H).

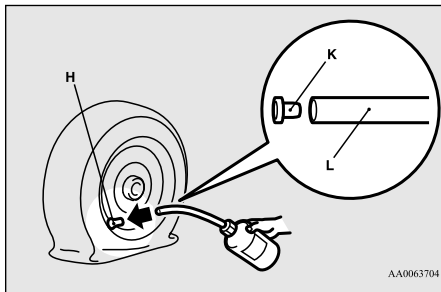

11. Holding the sealant bottle upside-down, squeeze it again and again to inject all of the sealant into the tyre.

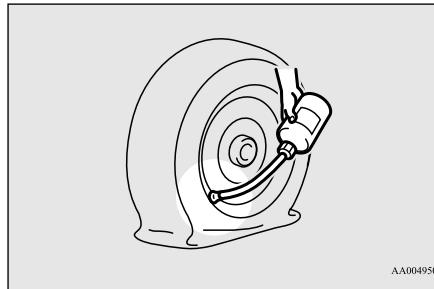

📖 NOTE

- When injecting the sealant, position the valve away from the bottom, i.e., away from the point where the tyre touches the ground. If the valve is near the point where the tyre touches the ground, the sealant may not go into the tyre easily.

12. After injecting the sealant, pull the hose off the valve, remove any residual sealant from the valve, rim and/or tyre. Fit the valve insert (J) into the valve (H), and screw the valve insert securely into place using the valve remover (I).

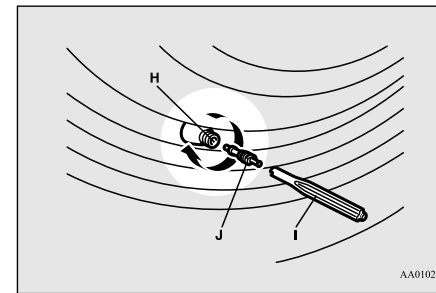

📖 NOTE

- When removing and screwing in the valve insert using the valve remover, turn the valve remover by hand. Using a tool to turn the valve remover could damage it.

13. Pull out the compressor hose (M) from the side of the tyre compressor, and then securely attach the hose to the tyre valve (H).

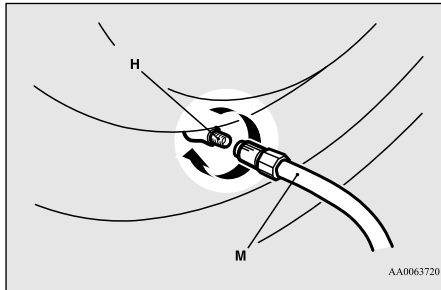

14. Place the compressor (N) with its air pressure gauge (O) on top.

Pull out the compressor's power cord (P), insert the plug on the cord into the accessory socket (Q), and then put the operation mode of the power switch in ACC. (Refer to "Accessory socket" on page 8-66.)

Turn ON the compressor switch (R) and inflate the tyre to the specified pressure. (Refer to "Tyre inflation pressures" on page 11-10.)

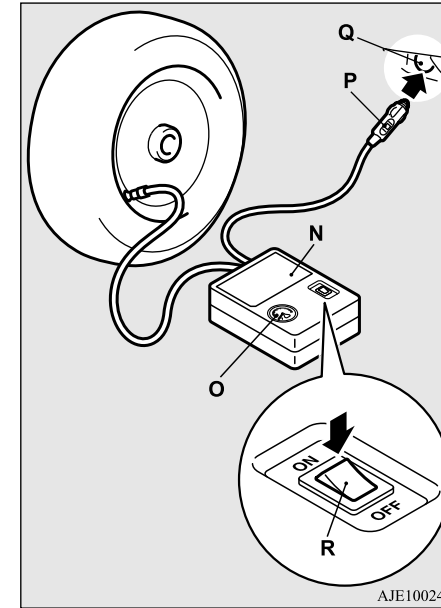

Tyre repair kit

9

CAUTION

- The supplied compressor is designed only for inflation of your vehicle tyres.
- The compressor is designed to run on a vehicle's 12 V power supply. Do not connect it to any other power source.
- The compressor is not waterproof. If you use it in rain, make sure water does not get on it.

For emergencies 9-11

Tyre repair kit

⚠ CAUTION

- Any sand or dust sucked into the compressor could make the compressor break down. Do not place the compressor directly on any sandy or dusty surface when using it.
- Do not disassemble or modify the compressor. Also, do not subject the air pressure gauge to shock. It could malfunction.

15. Check and adjust the tyre pressure with reference to the air pressure gauge on the compressor. If you overinflate the tyre, release air by loosening the hose's end fitting.

9

If there is a gap between the tyre and wheel because the tyre has moved inward from the wheel rim, press the periphery of the tyre towards the wheel to close the gap before running the compressor. (With no gaps, the tyre pressure will rise.)

⚠ CAUTION

- Be careful not to get your fingers trapped between the tyre and wheel as the tyre inflates.
- The surface of the compressor will get hot while the compressor is running. Do not keep the compressor running continuously for more than 10 minutes. After using the compressor, wait for the compressor to cool before using it again.

⚠ CAUTION

- If the compressor becomes sluggish or hot while operating, it is overheating. Immediately place the switch in the OFF position and let the compressor cool down for at least 30 minutes.

📖 NOTE

- If the tyre pressure does not rise to the specified level within 10 minutes, the tyre may be so severely damaged that the tyre sealant cannot be used to effect an emergency repair. Please contact a MITSUBISHI MOTORS Authorised Service Point or another specialist in this event.

16. Turn OFF the compressor switch, then pull the power cord plug out of the socket.

📖 NOTE

- Simply putting sealant and air into the tyre using the tyre repair kit does not seal the puncture hole. Air will leak through the puncture hole until the emergency repair procedure is completed (through step 19 or step 20 of these instructions).

17. Affix the speed restriction sticker (R) to the three-diamond mark on the steering wheel.

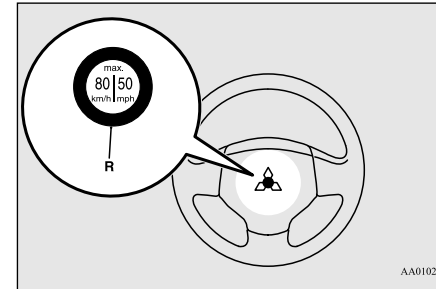

⚠ CAUTION

- Do not affix the sticker anywhere except the specified position on the pad of the steering wheel. Affixing the sticker in an incorrect position could prevent the SRS airbag from working normally.

Tyre repair kit

18. When you have inflated the tyre to the specified pressure, stow the compressor, bottle, and other items in the vehicle and promptly start driving the vehicle so that the tyre sealant can spread evenly in the tyre. Drive with great care. Do not exceed a speed of 80 km/h. Observe local speed limits.

CAUTION

- If you sense any abnormality while driving, stop the vehicle and contact a MITSUBISHI MOTORS Authorised Service Point or another specialist. Otherwise the tyre pressure may drop before the emergency repair procedure is completed, rendering the vehicle unsafe.

NOTE

- Driving faster than 80 km/h can make the vehicle vibrate.

19. After driving for 10 minutes or 5 km, check the tyre pressure using the air pressure gauge on the compressor. If the tyre pressure has apparently not dropped, the emergency repair procedure is complete. Continue the process from step 21. If the tyre pressure is not sufficient, inflate the tyre to the specified pressure again and drive the vehicle carefully without exceeding a speed of 80 km/h.

CAUTION

- If the tyre pressure is lower than the minimum permitted pressure (1.3 bar {130 kPa}), the tyre cannot successfully be repaired with the tyre sealant. Do not drive the vehicle any further. Contact a MITSUBISHI MOTORS Authorised Service Point or another specialist.

20. After driving for 10 minutes or 5 km, check the tyre pressure using the air pressure gauge on the compressor. If the tyre pressure has apparently not dropped, the emergency repair procedure is complete. You must still not exceed a speed of 80 km/h. Observe local speed limits.

NOTE

- If the tyre pressure has dropped below the specified level when you check it at the end of the repair procedure, do not drive the vehicle any further. Contact a MITSUBISHI MOTORS Authorised Service Point or another specialist.
- In cold conditions (when the ambient temperature is 0 °C or lower), the time and driving distance necessary until completion of the repair can be longer than in warmer conditions, meaning that the tyre pressure can drop below the specified level even when you have inflated the tyre a second time and subsequently driven the vehicle. If this happens, inflate the tyre to the specified pressure once more, drive for about 10 minutes or 5 km, then check the tyre pressure again. If the tyre pressure has again dropped below the specified level, stop driving the vehicle and contact a MITSUBISHI MOTORS Authorised Service Point or another specialist.

How to change a tyre

21. Immediately drive with great care to a MITSUBISHI MOTORS Authorised Service Point or another specialist and have tyre repair/replacement performed.

CAUTION

- Be sure to check the tyre pressure for confirmation that the emergency repair procedure is complete.

NOTE

- Please give the empty sealant bottle to your MITSUBISHI MOTORS Authorised Service Point when you purchase new sealant or dispose of the sealant bottle according to national regulations for the disposal of chemical waste.
- A tyre in which puncture sealant has been used should ideally be replaced with a new one. If you wish to have such a tyre properly repaired for reuse, please contact a MITSUBISHI MOTORS Authorised Service Point or another specialist. Note that a proper repair is impossible following an emergency repair if the puncture hole cannot be located.
- The manufacturer is unable to guarantee that all tyre punctures can be repaired with the tyre repair kit, in particular cuts or perforations with a diameter of more than 4 mm or away from the tyre's tread. The manufacturer is not liable for damage sustained through improper use of the tyre repair kit.

9

NOTE

- The manufacturer is not liable for damage sustained through re-use of any tyre in which tyre sealant has been used.

How to change a tyre

E00801203924

Before changing a tyre, first stop your vehicle in a safe, flat location.

1. Park the vehicle on level and stable ground, free of loose pebbles, etc.
2. Set the parking brake firmly.
3. Put the select position in "P" (PARK) position and stop the Plug-in Hybrid EV system.
4. Have all your passengers get out of the vehicle.

5. To prevent the vehicle from rolling when jacking up the vehicle, place chocks or blocks (A) at the tyre that is diagonally opposite from the tyre (B) you are changing.

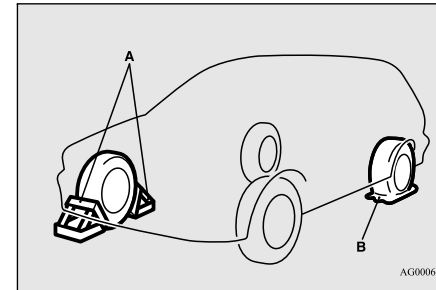

AG0006822

WARNING

- Be sure to apply chocks or blocks to the correct tyre when jacking up the vehicle. If the vehicle moves while jacked up, the jack could slip out of position, leading to an accident.

NOTE

- The chocks shown in the illustration do not come with your vehicle. It is recommended that you keep ones in the vehicle for use if needed.
- If chocks are not available, use stones or any other objects that are large enough to hold the wheel in position.

How to change a tyre

6. Get the jack, jack bar and wheel nut wrench ready.
Refer to “Tools and jack” on page 9-6.

To change a tyre

E00803201894

1. On vehicles with wheel covers, first remove the covers (refer to “Wheel covers” on page 9-18).
Then loosen the wheel nuts a quarter turn with the wheel nut wrench. Do not remove the wheel nuts yet.

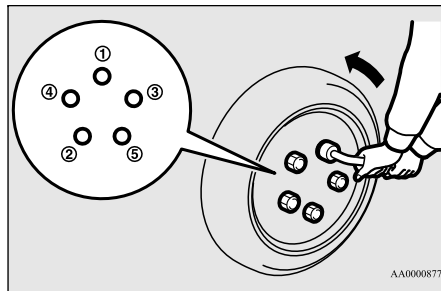

2. Place the jack under one of the jacking points (A) shown in the illustration. Use the jacking point closest to the tyre you wish to change.

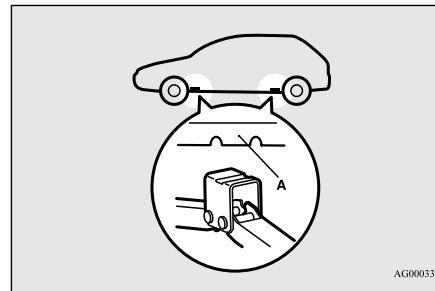

WARNING

- Set the jack only at the positions shown here. If the jack is set at a wrong position, it could dent your vehicle or the jack might fall over and cause personal injury.
- Do not use the jack on a tilted or soft surface. Otherwise, the jack might slip and cause personal injury. Always use the jack on a flat, hard surface. Before setting the jack, make sure there are no sand or pebbles under the jack base.

3. Rotate the jack by hand until the flange portion (B) fits in the groove (C) at the top of the jack.

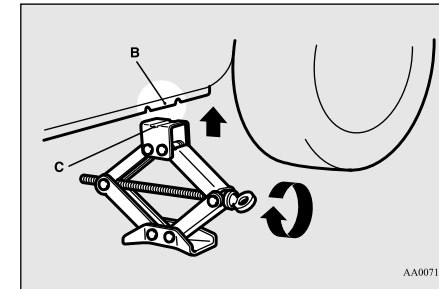

4. Insert the jack bar (D) into the wheel nut wrench (E). Then put the end of the jack bar into the shaft's jack end, as shown in the illustration.
- Slowly rotate the wheel nut wrench until the tyre is raised slightly off the ground surface.

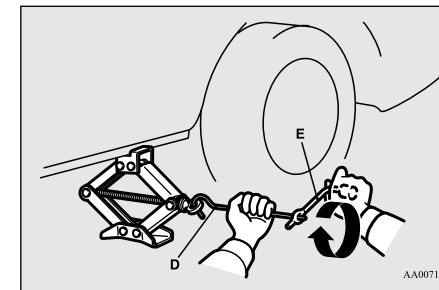

How to change a tyre

⚠ WARNING

- Stop jacking up the vehicle as soon as the tyre is raised off the ground. It is dangerous to raise the vehicle any higher.
- Do not get under a vehicle that is supported by a jack.
- Do not bump the raised vehicle or leave it sitting on the jack for a long time. Both are very dangerous.
- Do not use a jack except the one that came with your vehicle.
- The jack should not be used for any purpose other than to change a tyre.
- No one should be in your vehicle when using the jack.
- Do not start the Plug-in Hybrid EV system while your vehicle is on the jack.
- Do not turn the raised wheel. The tyres still on the ground could turn and make your vehicle fall off the jack.

5. Remove the wheel nuts with the wheel nut wrench, then take the wheel off.

⚠ CAUTION

- Handle the wheel carefully when changing the tyre, to avoid scratching the wheel surface.

6. Clean out any mud, etc. on the hub surface (F), hub bolts (G) or in the installation holes (H) in the wheel, and then mount the tyre.

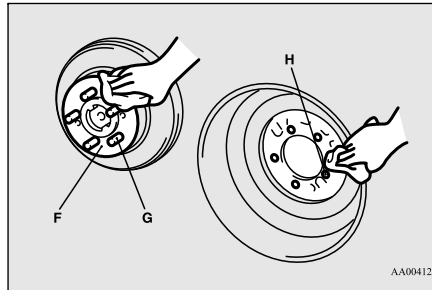

⚠ WARNING

- Mount the wheel with the valve stem (I) facing outboard. If you cannot see the valve stem (I), you have installed the wheel backwards. Operating the vehicle with the wheel installed backwards can cause vehicle damage and result in an accident.

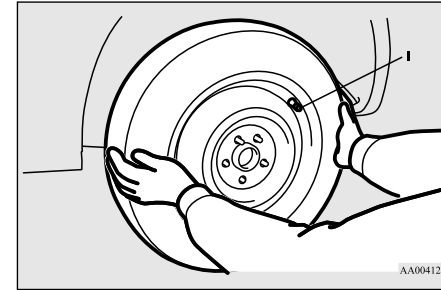

7. Turn the wheel nuts clockwise by hand to initially tighten them.

[Type 1: On vehicles with steel wheels]

Temporarily tighten the wheel nuts by hand until the tapered parts of the wheel nuts make light contact with the seats of the wheel holes and the wheel is not loose.

[Type 2: On vehicles with aluminium wheels]

Temporarily tighten the wheel nuts by hand until the flange parts of the wheel nuts make light contact with the wheel and the wheel is not loose.

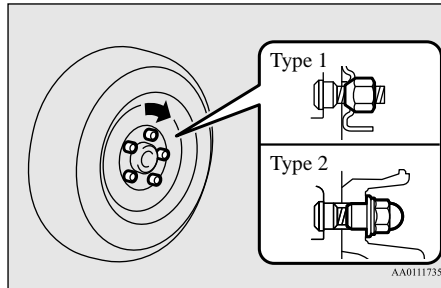

⚠ CAUTION

- Never apply oil to either the wheel bolts or the nuts or they will tighten too much.

NOTE

- On vehicles with aluminium wheels, if all 4 aluminium wheels are changed to steel wheels. e. g. when fitting winter tyres, use tapered nuts.

8. Lower the vehicle slowly by rotating the wheel nut wrench anticlockwise until the tyre touches the ground.

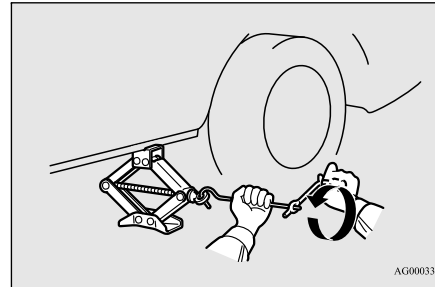

How to change a tyre

9. Tighten the nuts in the order shown in the illustration until each nut has been tightened to the torque listed here.

Tightening torque 88 to 108 N•m

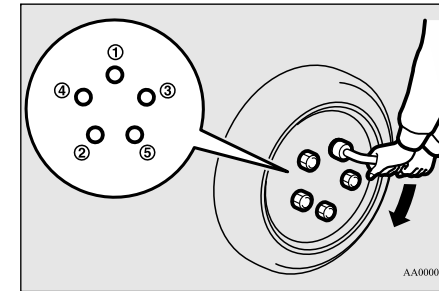

9

⚠ CAUTION

- Never use your foot or a pipe extension for extra force in the wheel nut wrench. If you do so, you will tighten the nut too much.

10. On vehicles with wheel covers, install the covers (refer to “Wheel covers” on page 9-18).

11. Lower and remove the jack, then store the jack, flat tyre, and chocks. Have your damaged tyre repaired as soon as possible.

For emergencies 9-17

How to change a tyre

12. Check your tyre inflation pressure at the next gas station. The correct tyre pressures are shown on the driver's door label. See the illustration.

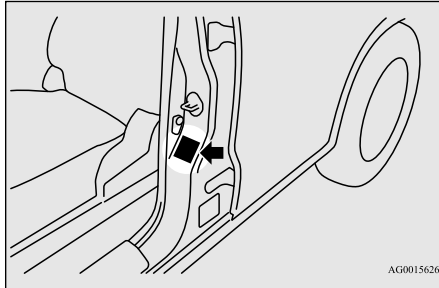

Refer to "Tools and jack" on page 9-6.

Wheel covers*

E00801300735

To remove

Wrap the tip of the jack bar with a cloth, insert it into the notch provided in the wheel cover, and pry the cover away from the wheel. Using the same procedure at the other wheel cover notches, work the wheel cover away from the wheel to remove it completely.

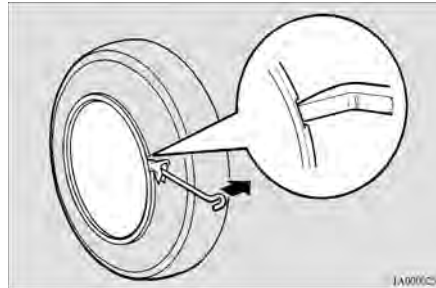

CAUTION

- Removing the cover with your hands may cause injury to the fingers.

NOTE

- The wheel cover is made of plastic. Pry it loose carefully.

To install

1. Make sure the tabs (A) of the back of the wheel cover are not broken and correctly fitted on the rings (B). If in doubt, do not install the wheel cover and consult your MITSUBISHI MOTORS Authorised Service Point.

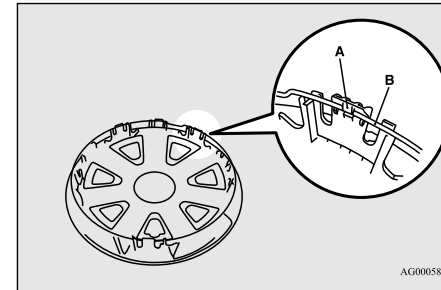

9

CAUTION

- After changing the tyre and driving the vehicle about 1000 km, retighten the wheel nuts to make sure that they have not come loose.
- If the steering wheel vibrates when driving after changing the tyre, we recommend you to have the tyres checked for balance.
- Do not mix one type of tyre with another or use a different size from the one listed. This would cause early wear and poor handling.

To store the tools and jack

E00803800037

Reverse the removing procedure when storing the jack, jack bar and wheel nut wrench.

9-18 For emergencies

Towing

2. Align the air valve (C) of the tyre with the notch (D) in the wheel cover.

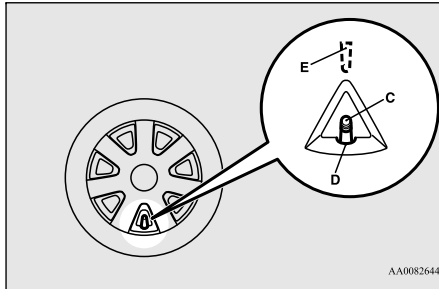

NOTE

- Full wheel covers have a symbol mark (E) provided on the reverse side to show the air valve location. Before installing the wheel cover to the wheel, make sure that the opening with the symbol mark is correctly aligned with the air valve.

3. Push the underside (F) of the wheel cover into the wheel.
4. Gently push both sides (G) of the wheel cover and hold it in place with both knees.

5. Gently tap around the circumference of the wheel cover at the top (H), then press the wheel cover into place.

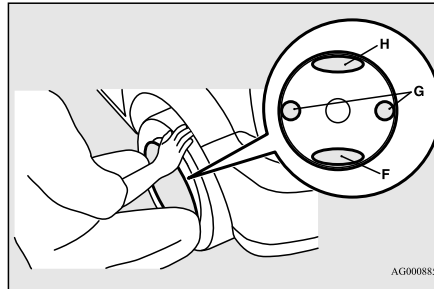

Towing

E00801504940

If your vehicle needs to be towed

If you need to tow your vehicle, contact a MITSUBISHI MOTORS Authorised Service Point or a commercial tow truck service. Transport the vehicle on a flatbed truck or tow the vehicle with all wheels off the ground.

Flat bed type

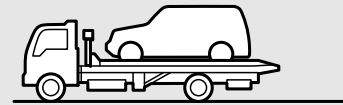

Dolly type

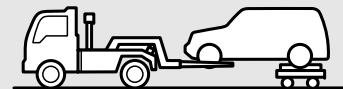

In the following cases, contact a MITSUBISHI MOTORS Authorised Service Point and transport the vehicle with the all wheels on a carriage.

- The ready indicator illuminates but the vehicle does not move, or an abnormal noise is produced.
- Some warning lamp in the meter illuminates.
- Inspection of the vehicle's underside reveals that oil or some other fluid is leaking.
- Your vehicle body is severely damaged or deformed in the event of an accident.

If a wheel gets stuck in a ditch, do not try to tow the vehicle.

For emergencies 9-19

Towing

Please contact your MITSUBISHI MOTORS Authorised Service Point or a commercial tow truck service for assistance.

Your vehicle may be temporarily towed by another vehicle with a rope in emergency situations such as running out of fuel.

If your vehicle is to be towed by another vehicle, tow your vehicle in a short distance as much as possible and carefully in accordance with the instructions given in "Emergency towing" in this part.

There may be local regulations concerning towing in your area. It is recommended that you obey the regulations of the area where you are driving your vehicle.

9

CAUTION

- If the drive-train or suspension has a problem, do not tow the vehicle with only the rear wheels or front wheels placed on a dolly.

Towing the vehicle by a tow truck

WARNING

- Never get under your vehicle after it has been lifted by a tow truck.
- Never ride in a vehicle that is being towed.

WARNING

- Never tow the vehicle with front wheels and/or rear wheels on the ground. This may cause damage to the electric motors and transaxle.

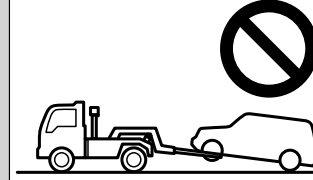
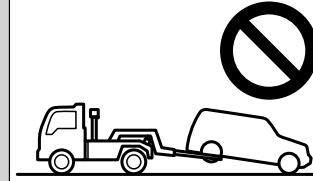
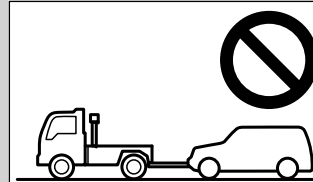

AJM100911

CAUTION

- Never tow the vehicle using a sling type truck. Doing so will damage the bumper and/or body.

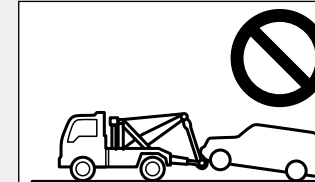

AJZ100332

Emergency towing

If your vehicle is temporarily towed by another vehicle with a rope in emergency situations such as running out of fuel, the towing distance shall be as short as possible and tow carefully in accordance with the following procedure.

If your vehicle is to be towed by another vehicle

⚠ WARNING

- **Never tow your vehicle in this method except in emergency situations such as running out of fuel. If the vehicle is towed in this method when a problem occurs in the vehicle such as when some warning lamp illuminates, the motor, transaxle, etc. may be damaged**

1. The front towing hooks are located as shown in illustration. Secure the tow rope to the front towing hook.

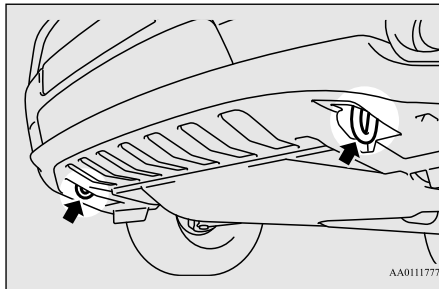

📖 NOTE

- Using any part other than the designated towing hook could result in damage to vehicle body.

📖 NOTE

- Using a wire rope or metal chain can result in damage to the vehicle body. It is best to use a non-metallic rope. If you use a wire rope or metal chain, wrap it with cloth at any point where it touches the vehicle body.
- Use care that the tow rope is kept as horizontal as possible. An angled tow rope can damage the vehicle body.
- Secure the tow rope to the same side towing hook, to keep the tow rope as straight as possible.

2. Start the Plug-in Hybrid EV system.
If the Plug-in Hybrid EV System cannot be started, put the operation mode of the power switch in "ON".

⚠ WARNING

- **If the vehicle is towed with the operation mode in "ON" without starting the Plug-in Hybrid EV System, the auxiliary battery may be fully discharged during towing. In this case, the brake performance becomes very poor and the steering wheel becomes very heavy.**

⚠ CAUTION

- For vehicle equipped with the Adaptive Cruise Control system (ACC) and Forward Collision Mitigation system (FCM), stop these systems to prevent an unexpected accident or unexpected operation during towing. Refer to "Adaptive Cruise Control system (ACC)" on page 7-43 and "Forward Collision Mitigation system (FCM)" on page 7-55.

3. Put the select position in "N" (NEUTRAL) position.
4. Turn on the hazard warning lamps if required by law. (Follow the local driving laws and regulations)
5. During towing make sure that close contact is maintained between the drivers of both vehicles, and that the vehicles travel at low speed.

⚠ WARNING

- **Avoid sudden braking, acceleration and steering wheel movements; such driving operation could cause damage to the towing hook or towing rope. People in the vicinity could be injured as a result.**
- **When going down a long slope, the brakes may overheat, reducing effectiveness. Have your vehicle transport by a tow truck.**

Operation under adverse driving conditions

CAUTION

- The person in the vehicle being towed must pay attention to the brake lamps of the towing vehicle and make sure the rope never becomes slack.
- When the vehicle is to be towed by another vehicle with the all wheels on the ground, make sure that the towing speed and distance given below are never exceeded, avoiding damage to the transaxle.

Towing speed: 30 km/h
Towing distance: 30 km

For the towing speed and the towing distance, follow the local driving laws and regulations.

9

If your vehicle tows another vehicle

Only use the rear towing hook as shown in the illustration.

Secure the tow rope to the rear towing hook. Otherwise, the instructions are the same as for “When being towed by another vehicle”.

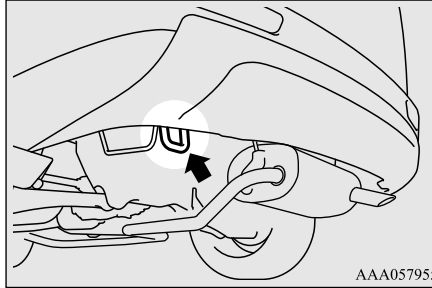

NOTE

- Using any part other than the designated towing hook could result in damage to vehicle body.

NOTE

- Do not tow a vehicle heavier than your own vehicle.

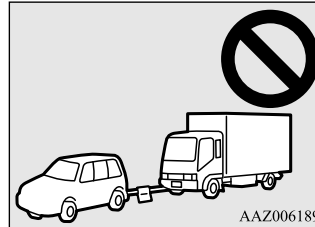

Operation under adverse driving conditions

E00801703828

If your vehicle becomes stuck in sand, mud or snow

If your vehicle becomes stuck in snow, sand, or mud, it can often be moved by a rocking motion. Rock your vehicle back and forth to free it.

Do not spin the wheels. Constant efforts to free a stuck vehicle can cause transaxle failure.

If your vehicle is still stuck after several rocking attempts, call for a commercial tow truck service.

WARNING

- When trying to rock your vehicle out of a stuck position, make sure that there are no people nearby. The rocking motion can make your vehicle suddenly lurch forward or backward, and injure any bystanders.

On a flooded road

- Do not drive on a flooded road. If you drive on a flooded road, not only the Plug-in Hybrid EV System stops but also a failure like electric leakage or short circuit may occur.

If you inevitably had to run on a flooded road and the vehicle was exposed to water, be sure to have your vehicle inspected by a MITSUBISHI MOTORS Authorised Service Point.

- If there is water on the brakes after driving through puddles or washing the vehicle, resulting in temporarily ineffective brakes. In such cases, lightly depress the brake pedal to see if the brakes operate properly. If they do not, lightly depress the pedal several times while driving in order to dry the brake pads.
- When driving in rain or on a road with many puddles a layer of water may form between the tyres and the road surface. This reduces a tyre's frictional resistance on the road, resulting in loss of steering stability and braking capability.

To cope with this, observe the following items:

- (a) Drive your vehicle at a slow speed.
- (b) Do not drive on worn tyres.

- (c) Always maintain the specified tyre inflation pressures.

On a snow-covered or frozen road

- When driving on a snow-covered or frozen road, it is recommended that you use snow tyres or snow traction device (tyre chains).

Refer to the "Snow tyres" and "Snow traction device (tyre chains)" sections.

- Avoid high-speed operation, sudden acceleration, abrupt brake application and sharp cornering.
- Depressing the brake pedal during travel on snowy or icy roads may cause tyre slippage and skidding. When traction between the tyres and the road is reduced the wheels may skid and the vehicle cannot readily be brought to a stop by conventional braking techniques. Braking will differ, depending upon whether you have anti-lock brake system (ABS). As your vehicle is equipped with ABS, brake by pressing the brake pedal hard, and keeping it pressed.
- Allow extra distance between your vehicle and the vehicle in front of you, and avoid sudden braking.

Operation under adverse driving conditions

- Accumulation of ice on the braking system can cause the wheels to lock. Pull away from a standstill slowly after confirming safety around the vehicle.

⚠ CAUTION

- Do not press the accelerator pedal rapidly. If the wheels break free of the ice, the vehicle could suddenly start moving and possibly cause an accident.

On a bumpy or rutted road

Drive as slow as possible when driving on bumpy or rutted roads.

⚠ CAUTION

- The impact on tyres and/or wheels when driving on a bumpy or rutted road can damage the tyre and/or wheel.

This vehicle is intended for driving mainly on roads with firm surface.

4WD system makes possible driving on roads without special coverage, on flat and firm surface. Please, remember that off-road ability of your vehicle is limited. Your vehicle is not intended for driving in heavy off-road, overcoming the rugged terrain, deep ruts, etc.

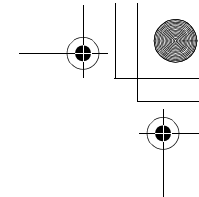
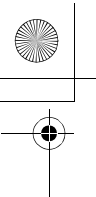

Operation under adverse driving conditions

Manufacturer of the vehicle is proceeding from the following assumption:
taking the decision to keep driving under conditions mentioned above, driver takes all actions at own risk, aware of possible consequences.

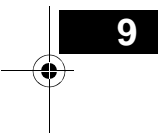

9

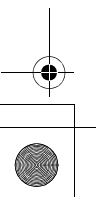
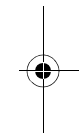

9-24 For emergencies

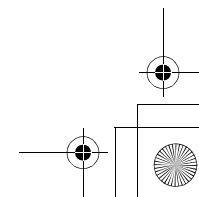
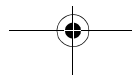

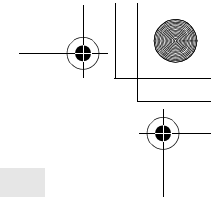
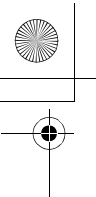

Vehicle care

Vehicle care precautions	10-2
Cleaning the interior of your vehicle	10-2
Cleaning the exterior of your vehicle	10-3

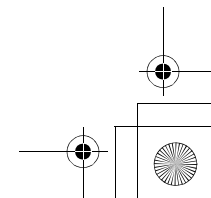
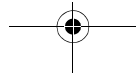
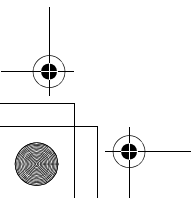
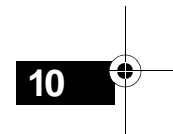
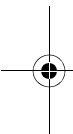

Vehicle care precautions

Vehicle care precautions

E00900100548

In order to maintain the value of your vehicle, it is necessary to perform regular maintenance using the proper procedures.

Always maintain your vehicle in compliance with any environmental pollution control regulations.

Carefully select the materials used for washing, etc., to be sure that they do not contain corrosives.

If in doubt, we recommend you to consult a specialist for the selection of these materials.

10

CAUTION

- Cleaning products can be dangerous. Always follow the instructions of the cleaning product supplier.
- To avoid damage, never use the following to clean your vehicle.
 - Petrol
 - Paint Thinner
 - Benzine
 - Kerosene
 - Turpentine
 - Naphtha
 - Lacquer Thinner
 - Carbon Tetrachloride
 - Nail Polish Remover
 - Acetone

Cleaning the interior of your vehicle

E00900200611

After cleaning the interior of your vehicle with water, cleaner or similar, wipe and dry in a shady, well-ventilated area.

NOTE

- To clean the inside of the tailgate window, always use a soft cloth and wipe the window glass along the demister heater element so as not to cause damage.

CAUTION

- Do not use organic substances (solvents, benzine, kerosene, alcohol, petrol, etc.) or alkaline or acidic solutions. These chemicals can cause discolouring, staining or cracking of the surface. If you use cleaners or polishing agents, make sure their ingredients do not include the substances mentioned above.

Plastic, vinyl leather, fabric and flocked parts

E00900301459

1. Lightly wipe these off with a soft cloth soaked in a mild soap and water solution.

2. Dip cloth in fresh water and wring it out well. Using this cloth, wipe off the detergent thoroughly.

NOTE

- Do not use cleaners, conditioners, and protectants containing silicones or wax. Such products can cause discolouring and, when applied to the instrument panels or other parts, may cause reflections on the windscreen and obscure vision. Also, if such products get on the switches of the electrical accessories, it may lead to failure of these accessories.
- Do not use synthetic fiber or dry cloth. They can cause discolouring or damaging the surface.
- Do not place a deodorizer on the instrument panel or near lamps and instruments. The ingredients for deodorizer can cause discolouring or cracking.

Upholstery

E00900500207

1. To maintain the value of your new vehicle, handle the upholstery carefully and keep the interior clean.
Use a vacuum cleaner and brush to clean the seats. If stained, vinyl and synthetic leather should be cleaned with an appropriate cleaner. Cloth fabrics can be cleaned with either upholstery cleaner or a mild soap and water solution.
2. Clean the carpeting with a vacuum cleaner and remove any stains with carpet cleaner. Oil and grease can be removed by lightly dabbing with a clean colourfast cloth and stain remover.

Genuine leather*

E00900600950

1. To clean, lightly wipe the leather with a soft cloth soaked in a mild soap and water solution.
2. Dip cloth in fresh water and wring it out well. Using this cloth, wipe off the detergent thoroughly.
3. Apply leather protecting agent to the genuine leather surface.

NOTE

- If genuine leather is wet with water or is washed in water, wipe off water as quickly as possible with a dry, soft cloth.
If left damp, mildew may grow.
- Organic solvents such as benzine, kerosene, alcohol and petrol, acid or alkaline solvents may discolour the genuine leather surface. Be sure to use neutral detergents.
- Remove dirty patches or oil substances quickly as they can stain genuine leather.
- The genuine leather surface may harden and shrink if it is exposed to direct rays of the sun for long hours. When your vehicle is parked, place it in the shade as much as possible.
- When the temperature of the vehicle interior rises in summer, vinyl products left on the genuine leather seat may deteriorate and stick to the seat.

Cleaning the exterior of your vehicle

E00900700108

If the following is left on your vehicle, it may cause corrosion, discolouration and stains, wash the vehicle as soon as possible.

- Seawater, road deicing products.

Cleaning the exterior of your vehicle

- Soot and dust, iron powder from factories, chemical substance (acids, alkalis, coal-tar, etc.).
- Droppings from birds, carcasses of insects, tree sap, etc.

Washing

E00900903547

Chemicals contained in the dirt and dust picked up from the road surface can damage the paint coat and body of your vehicle if left in prolonged contact.

Frequent washing and waxing is the best way to protect your vehicle from this damage. This will also be effective in protecting it from environmental elements such as rain, snow, salt air, etc.

Do not wash the vehicle in direct sunlight. Park the vehicle in the shade and spray it with water to remove dust. Next, using an ample amount of clean water and a car washing brush or sponge, wash the vehicle from top to bottom.

Use a mild car washing soap if necessary. Rinse thoroughly and wipe dry with a soft cloth. After washing the vehicle, carefully clean the joints and flanges of the doors, bonnet and other sections where dirt is likely to remain.

Cleaning the exterior of your vehicle

Sea water spray in coastal conditions

Sea water contains salt, which generally accelerates corrosion of both ferrous and non-ferrous materials. Wind born spray from the sea can distribute salt for a distance of up to 20 km from the shore line with prevailing on-shore winds, although the effect is generally worse within 2 km of the shore. Salt spray covers roads, and may be passed to your vehicle as dust, or as salt spray after rain. For this reason it is important to wash all the vehicle including the underside (not forgetting the plug-in hybrid EV system bay and plug-in hybrid EV system bay components). See section entitled "Engine compartment" for recommended cleaning practices.

Ensure you request a MITSUBISHI MOTORS Authorised Service Point to conduct the scheduled Preventative Maintenance corrosion inspection if you live within 20 km of the sea.

⚠ WARNING

- Do not wash the vehicle while charging the traction battery. Doing so could cause a fire or an electric shock.

⚠ WARNING

- Before washing the vehicle, make sure that the charging lid and the inner lid are completely closed. If the lid is open, the charging unit is exposed to water, resulting in a fire or an electric shock.

⚠ CAUTION

- When washing the under side of your vehicle or wheel, be careful not to injure your hands.
- If your vehicle has rain sensor wipers, place the wiper switch lever in the "OFF" position to deactivate the rain sensor before washing the vehicle. Otherwise, the wipers will operate in the presence of water spray on the windscreen and may get damaged as a result.
- Refrain from excessively using a car wash as its brushes may scratch the paint surface, causing it to lose its gloss. Scratches will be especially visible on darker coloured vehicles.
- Never spray or splash water on the electrical components in the engine compartment. Doing so could have an adverse effect on the plug-in hybrid EV system startability. Exercise caution also when washing the underbody; be careful not to spray water into the engine compartment.

⚠ CAUTION

- Some types of hot water washing equipment apply high pressure and heat to the vehicle. They may cause heat distortion and damage to the vehicle resin parts and may result in flooding of the vehicle interior. Therefore;
 - Maintain a distance of approx. 70 cm or more between the vehicle body and the washing nozzle.
 - When washing around the door glass, hold the nozzle at a distance of more than 70 cm and at right angles to the glass surface.
- After washing the vehicle, drive the vehicle slowly while lightly depressing the brake pedal several times in order to dry out the brakes. Leaving the brakes wet could result in reduced braking performance. Also, there is a possibility that they could freeze up or become inoperative due to rust, rendering the vehicle unable to move.
- Using an automatic car wash, pay attention to the following items, referring to the operation manual or consulting a car wash operator. If the following procedure is not followed, it could result in damage to your vehicle.
 - The outside rear-view mirrors are retracted.
 - The antenna is removed.
 - The wiper arms are secured in place with tape.

CAUTION

- If your vehicle is equipped with a roof rails, consult a car wash operator before using the car washer.
- If your vehicle has rain sensor wipers, place the wiper switch lever in the "OFF" position to deactivate the rain sensor.

During cold weather

The salt and other chemicals spread on the roads in some areas in winter can have a harmful effect on the vehicle body. You should therefore wash the vehicle as often as possible in accordance with our care-instructions. It is recommended to have a preservative applied and the underfloor protection checked before and after the cold weather season.

After washing your vehicle, wipe off all waterdrops from the rubber parts around the doors to prevent the doors from freezing.

NOTE

- To prevent freezing of the weatherstripping on the doors, bonnet, etc., they should be treated with silicone spray.

Waxing

E00901000919

Waxing the vehicle will help prevent the adherence of dust and road chemicals to the paintwork. Apply a wax solution after washing the vehicle, or at least once every three months to assist displacing of water.

Do not wax your vehicle in direct sunlight. You should wax after the surfaces have cooled.

For information on how to use wax refer to the instruction manual of the wax.

CAUTION

- Waxes containing high abrasive compounds should not be used.
- On vehicles with the sunroof, be careful when waxing the area around the sunroof opening, not to put any wax on the weatherstrip (black rubber). If stained with wax, the weatherstrip cannot maintain a weatherproof seal with the sunroof.

Polishing

E00901100066

The vehicle should only be polished if the paintwork has become stained or lost its lustre. Do not polish parts with a mat coating and the plastic bumpers. Doing so could cause stains or damage the finish.

Cleaning the exterior of your vehicle**Cleaning plastic parts**

E00901300808

Use a sponge or chamois leather.

If a car wax adheres on a grey or black rough surface of the bumper, moulding or lamps, the surface becomes white. In such a case, wipe it off using lukewarm water and soft cloth or chamois leather.

CAUTION

- Do not use a scrubbing brush or other hard tools as they may damage the plastic part surface.
- Do not bring the plastic parts into contact with petrol, light oil, brake fluids, engine oils, greases, paint thinners, and sulphuric acid (battery electrolyte) which may crack, stain or discolour the plastic parts. If they touch the plastic parts, wipe them off with soft cloth, chamois or the like and an aqueous solution of neutral detergent then immediately rinse the affected parts with water.

10

Chrome parts

E00901400098

In order to prevent spots and corrosion of chrome parts, wash with water, dry thoroughly, and apply a special protective coating. This should be done more frequently in winter.

Cleaning the exterior of your vehicle

Aluminium wheels*

E00901500347

1. Remove dirt using a sponge while sprinkling water on the vehicle.
2. Use neutral detergent on any dirt that cannot be removed easily with water.
Rinse off the neutral detergent after washing the vehicle.
3. Dry the vehicle thoroughly using a chamois leather or a soft cloth.

CAUTION

- Do not use a brush or other hard implement on the wheels.
Doing so could scratch the wheels.
- Do not use any cleaner that contains an abrasive substance or is acidic or alkaline. Doing so could cause the coating on the wheels to peel or become discoloured or stained.
- Do not directly apply hot water using a steam cleaner or by any other means.
- Contact with seawater and road deicer can cause corrosion. Rinse off such substances as soon as possible.

Window glass

E00901600117

The window glass can normally be cleaned using only a sponge and water.

Glass cleaner can be used to remove oil, grease, insect carcasses, etc. After washing

the glass, wipe it dry with a clean, dry, soft cloth. Never use a cloth that is used for cleaning a painted surface to clean a window. Wax from the painted surface could get on the glass and lower glass transparency and visibility.

NOTE

- To clean the inside of the rear window, always use a soft cloth and wipe the window glass along the demister heater element so as not to cause damage.

Wiper blades

E00901700062

Use a soft cloth and glass cleaner to remove grease, dead insects, etc., from the wiper blades. Replace the wiper blades when they no longer wipe properly. (Refer to page 11-12.)

Cleaning the sunroof*

E00902200051

Use a soft cloth to clean the inner side of the sunroof. Hard deposits should be wiped away with a cloth dipped in warm, neutral detergent solution. Wipe away the solution with a sponge dipped in fresh water.

NOTE

- The surface treatment on the inside of the glass may be removed if hard cloth or organic solvent (benzine, kerosene, thinner, etc.) is used.

Engine compartment

E00902100483

Clean the engine compartment at the beginning of autumn and end of winter. Pay particular attention to flanges, crevices and peripheral parts where dust containing road chemicals and other corrosive materials might collect.

If salt and other chemicals are used on the roads in your area, or you live within 20 km of the sea, clean the engine compartment at least every three months.

Never spray or splash water on the electrical components in the engine compartment, as this may cause damage.

Do not bring the nearby parts, the plastic parts and so on into contact with sulphuric acid (battery electrolyte) which may crack, stain or discolour them.

If they are in contact, wipe off with soft cloth, chamois or the like and an aqueous solution of neutral detergent then immediately rinse the affected parts with plenty of water.

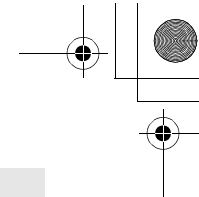
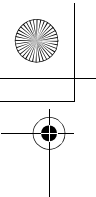

Maintenance

Service precautions	11-2
Catalytic converter	11-3
Bonnet	11-3
Engine oil	11-5
Engine coolant/Plug-in hybrid EV system coolant	11-6
Washer fluid	11-7
Brake fluid	11-7
Auxiliary battery	11-8
Tyres	11-9
Wiper blade rubber replacement	11-12
General maintenance	11-14
Fusible links	11-15
Fuses	11-15
Replacement of lamp bulbs	11-21

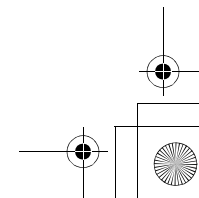
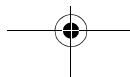
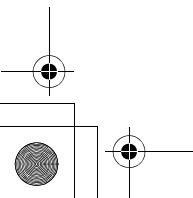
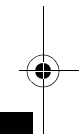
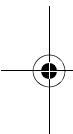

Service precautions

Service precautions

E01000102032

Adequate care of your vehicle at regular intervals serves to preserve the value and appearance as long as possible.

Maintenance items as described in this owner's manual can be performed by the owner.

We recommend you to have the periodic inspection and maintenance performed by a MITSUBISHI MOTORS Authorised Service Point or another specialist.

In the event a malfunction or a problem is discovered, we recommend you to have it checked and repaired. This section contains information on inspection maintenance procedures that you can do yourself. Follow the instructions and cautions for each of the various procedures.

11

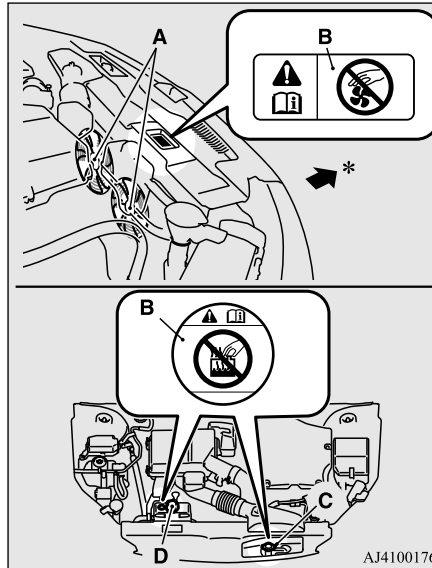

- A- Cooling fans
- B- Caution label
- C- Radiator cap
- D- EV cooling reserve tank cap
- *: Front of the vehicle

WARNING

- Before performing inspection or maintenance, be sure to disconnect the normal charge connector from the vehicle and confirm that the operation mode of the power switch is set to "OFF".

WARNING

- Never touch the high-voltage parts in the engine compartment. Never remove or disassemble the high-voltage components, cables (orange) or connectors. Also, never disassemble normal charging cables, normal charge connector, plugs or outlet. Failure to observe this instruction could cause an electric shock which result in a serious injury or death. These parts have labels that indicate handling precautions. Follow the instruction on these labels. Contact a MITSUBISHI MOTORS Authorised Service Point for any necessary maintenance. Refer to "High-Voltage components" on page 2-7.
- When checking or servicing the inside of the engine compartment, make sure the plug-in hybrid EV system is switched off and has had a chance to cool down.
- If it is necessary to do work in the engine compartment with the plug-in hybrid EV system starting, be especially careful that your clothing, hair, etc., does not become caught by the cooling fans, drive belts, or other moving parts.
- The cooling fans can turn on automatically even if the plug-in hybrid EV system is stopping. Put the operation mode of the power switch in OFF to be safe while you work in the engine compartment.

Catalytic converter

⚠ WARNING

- Make sure that the engine and Plug-in Hybrid EV system has cooled down before removing the radiator cap and EV cooling system reserve tank cap, because hot steam or boiling water otherwise will gush from the filler port and may scald you.
- Do not smoke, cause sparks or allow open flames around fuel or auxiliary battery. The fumes are flammable.
- Be extremely cautious when working around the auxiliary battery. It contains poisonous and corrosive sulphuric acid.
- Do not get under your vehicle with just the body jack supporting it. Always use automotive jack stands.
- Improper handling of components and materials used in the vehicle can endanger your personal safety. We recommend you to consult a specialist for necessary information.
- The components inside the engine room might be very hot to the touch.
To avoid being burnt, make sure all components have sufficiently cooled before beginning an inspection. These components are affixed with the label indicating precautions for handling. Follow the instructions on the label.

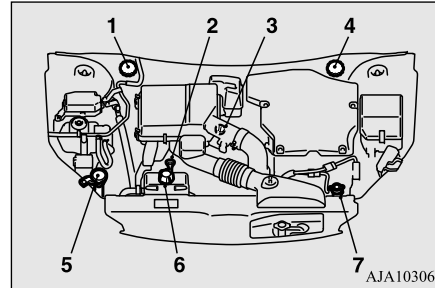

- 1- Brake fluid reservoir (RHD)
- 2- Engine oil level gauge
- 3- Engine oil cap
- 4- Brake fluid reservoir (LHD)
- 5- Washer fluid reservoir
- 6- EV cooling system reservoir
- 7- Engine coolant reservoir

Catalytic converter

E01000202437

The exhaust gas scavenging devices used with catalytic converter are extremely efficient for the reduction of noxious gases. The catalytic converter is installed in the exhaust system.

It is important to keep the engine properly tuned to ensure proper catalyst operation and prevent possible catalyst damage.

⚠ WARNING

- As with any vehicle, do not park or operate this vehicle in areas where combustible materials such as dry grass or leaves can come in contact with a hot exhaust since a fire could occur.
- Paint should not be applied to the catalytic converter.

📖 NOTE

- Use fuel of the type recommended in "Fuel selection" on page 2.

Bonnet

E01000303868

11

To open

1. Pull the release lever towards you to unlock the bonnet.

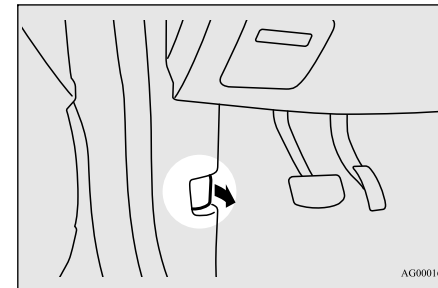

Bonnet

2. Raise the bonnet while pressing the safety lock.

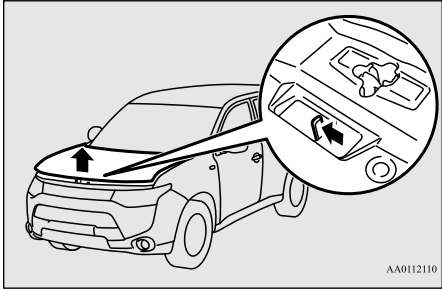

NOTE

- Only open the bonnet when the wipers are in the parked position. In any other position, the wipers could damage the paint or bonnet.

11

3. Support the bonnet by inserting the support bar in its slot.

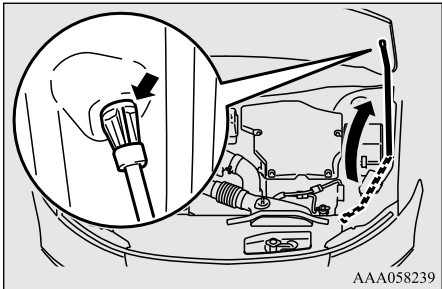

CAUTION

- Note that the support bar may disengage the bonnet if the open bonnet is lifted by a strong wind.
- After inserting the support bar into the slot, make sure the bar supports the bonnet securely from falling down on to your head or body.

To close

1. Unlatch the support bar and clip it in its holder.
2. Slowly lower the bonnet to a position about 20 cm above the closed position, then let it drop.
3. Make sure the bonnet is securely locked by softly lifting the centre of the bonnet.

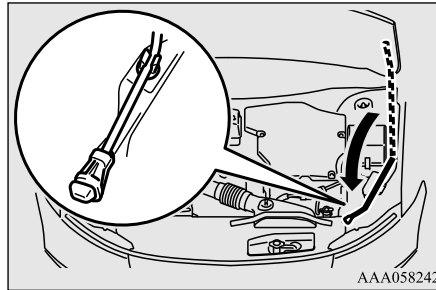

CAUTION

- Be careful that hands or fingers are not trapped when closing the bonnet.
- Before driving, make sure that the bonnet is securely locked. An incompletely locked bonnet can suddenly open while driving. This can be extremely dangerous.

NOTE

- If this does not close the bonnet, release it from a slightly higher position.
- Do not press down firmly on the bonnet as doing so could damage it.
- For vehicles equipped with the security alarm system, if you drive with the bonnet left open, warning display is displayed on the information screen in the multi information display.



Engine oil

E01000404039

To check and refill engine oil

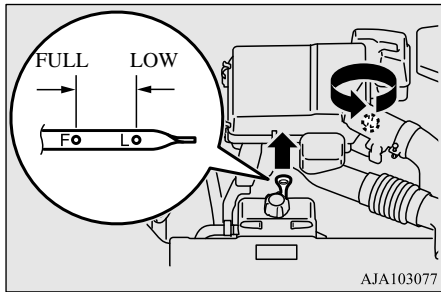

The engine oil used has a significant effect on the engine's performance, service life and startability. Be sure to use oil of the recommended quality and appropriate viscosity. All engines consume a certain amount of oil during normal operation. Therefore, it is important to check the oil level at regular intervals or before starting a long trip.

1. Park the car on a horizontal surface.
2. Switch off the engine.
3. Wait a few minutes.
4. Remove the dipstick and wipe it with a clean cloth.
5. Reinsert the dipstick as far as it goes.

6. Remove the dipstick and read the oil level, which should always be within the range indicated
7. If the oil level is below the specified limit, remove the cap located on the cylinder head cover and add enough oil to raise the level to within the specified range. Do not overfill to avoid engine damage. Be sure to use the specified engine oil and do not mix various types of oil.
8. After adding oil, close the cap securely.
9. Confirm the oil level by repeating step 4 to 6.

NOTE

- The engine oil will deteriorate rapidly if the vehicle is subjected to severe conditions, requiring earlier oil replacement. Please refer to the maintenance schedule.
- For information on how to dispose of used engine oil, refer to page 2-15.

Engine oil

Recommended engine oil viscosity

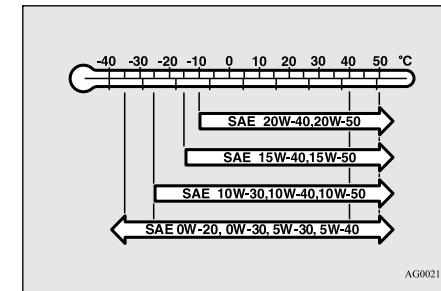

- Select engine oil of the proper SAE viscosity number according to the atmospheric temperature.
SAE 0W-20, 0W-30, 5W-30, and 5W-40 engine oils can only be used if they meet ACEA A3/B3, A3/B4 or A5/B5 and API SG (or higher) specifications.
- Use engine oil conforming to the following classification:
 - API classification: "For service SG" or higher
 - ILSAC certificated oil
 - ACEA classification: "For service A1/B1, A3/B3, A3/B4, or A5/B5"

Engine coolant/Plug-in hybrid EV system coolant

NOTE

- Use of additives is not recommended since they may reduce the effectiveness of additives already included in the engine oil. It may result in failure of the mechanical assembly.

Engine coolant/Plug-in hybrid EV system coolant

E01000503105

To check the coolant level

11

A transparent engine coolant reserve tank (A) and EV cooling system reserve tank (B) is located in the engine compartment. The coolant level in this tank should be kept between the “LOW” and “FULL” marks when measured while the engine and the plug-in hybrid EV system are cold.

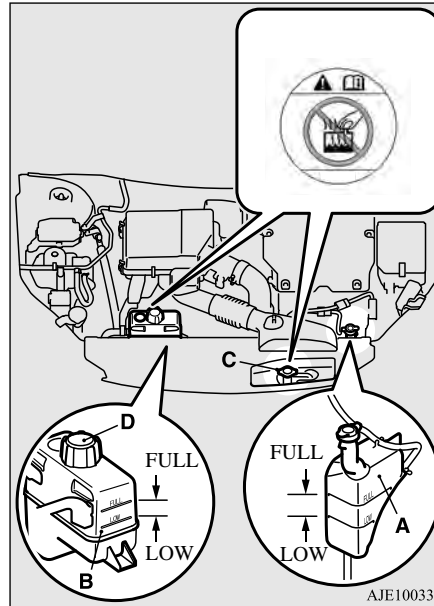

*: Front of the vehicle

To add coolant

The cooling system is a closed system and normally the loss of coolant should be very slight. A noticeable drop in the coolant level could indicate leakage. If this occurs, we recommend you to have the system checked as soon as possible.

If the level should drop below the “LOW” level on the reserve tank, open the lid and add coolant.

Also, if the reserve tank is completely empty, remove the radiator cap (C) or the reserve tank cap (D) and add coolant until the level reaches the filler neck.

WARNING

- Do not open the radiator cap (C) and the reserve tank cap (D) while the engine and the plug-in hybrid EV system are hot. The coolant system is under pressure and any hot coolant escaping could cause severe burns.

Anti-freeze

The engine coolant and the plug-in hybrid EV system coolant contains an ethylene glycol anti-corrosion agent. Some parts of the engine and the plug-in hybrid EV system are cast aluminium alloy, and periodic changing of the engine coolant and the plug-in hybrid EV system coolant are necessary to prevent corrosion of these parts.

Use “MITSUBISHI MOTORS GENUINE SUPER LONG LIFE COOLANT PREMIUM” or equivalent*.

*:similar high quality ethylene glycol based non-silicate, non-amine, non-nitrate and non-borate coolant with long life hybrid organic acid technology

MITSUBISHI MOTORS GENUINE Coolant has excellent protection against corrosion and rust formation of all metals including aluminium and can avoid blockages in the radiator, heater, cylinder head, engine block, etc. Because of the necessity of this anti-corrosion agent, the coolant must not be replaced with plain water even in summer. The required concentration of anti-freeze differs depending on the expected ambient temperature.

Above -35 °C: 50 % concentration of anti-freeze
Below -35 °C: 60 % concentration of anti-freeze

CAUTION

- Do not use alcohol or methanol anti-freeze or any engine coolants mixed with alcohol or methanol anti-freeze. The use of an improper anti-freeze can cause corrosion of the aluminium components.
- Do not use water to adjust the concentration of coolant.
- Concentrations exceeding 60 % will result in a reduction of both the anti-freeze and cooling performance thus adversely affecting the engine.

CAUTION

- Do not top up with water only. Water by itself reduces the rust-protective and anti-freeze qualities of the coolant and has a lower boiling point. It can also cause damage to the cooling system if it should freeze. Do not use tapwater, as it can cause corrosion and rust formation.

During cold weather

If the temperatures in your area drop below freezing, there is the danger that the coolant in the engine, plug-in hybrid EV system or radiator could freeze and cause severe damage to the engine and/or radiator. Add a sufficient amount of anti-freeze to the coolant to prevent it from freezing.

The concentration should be checked before the start of cold weather and anti-freeze added to the system if necessary.

Washer fluid

E01000700890

Open the washer fluid reservoir cap and check the level of washer fluid with the dipstick.

If the level is low, replenish the container with washer fluid.

Washer fluid

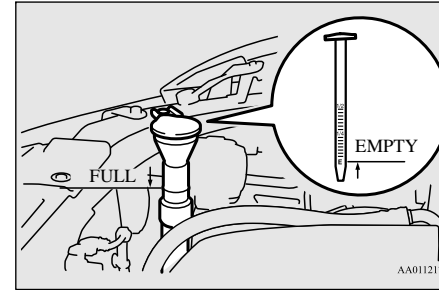

NOTE

- The washer fluid container serves the windscreen, rear window and headlamps (if so equipped).

During cold weather

11

To ensure proper operation of the washers at low temperatures, use a fluid containing an anti-freezing agent.

Brake fluid

E01000801696

To check the fluid level

The fluid level must be between the "MAX" and "MIN" marks on the reservoir.

Auxiliary battery

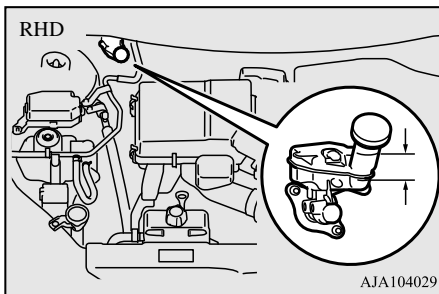
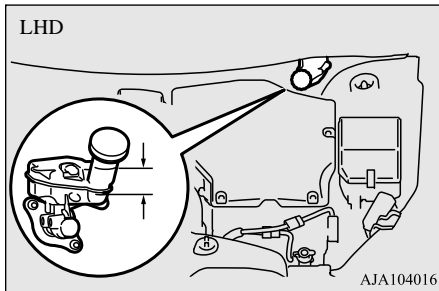

11

The fluid level is monitored by a float. When the fluid level falls below the “MIN” mark, the brake fluid warning lamp lights up. The fluid level falls slightly with wear of the brake pads, but this does not indicate any abnormality.

The fluid in the master cylinder should be checked when doing other work under the

bonnet. The brake system should also be checked for leaks at the same time.

If the fluid level falls markedly in a short length of time, it indicates leaks from the brake system.

If this occurs, we recommend you to have the vehicle checked.

Fluid type

Use brake fluid conforming to DOT3 or DOT4 from a sealed container. The brake fluid is hygroscopic. Too much moisture in the brake fluid will adversely affect the brake system, reducing the performance.

CAUTION

- Take care in handling brake fluid as it is harmful to the eyes, may irritate your skin and also damage to painted surfaces.
- Use only the specified brake fluid.
Do not mix or add different brand of brake fluid to prevent chemical reaction.
Do not let any petroleum-based fluid touch, mix with, or get into the brake fluid.
This will damage the seals.
- Keep the reservoir tank cap closed to prevent the brake fluid from deteriorating except maintenance.
- Clean the filler cap before removing and close the cap securely after maintenance.

Auxiliary battery

E01001203284

The condition of the auxiliary battery is very important for quick starting of the plug-in hybrid EV system and proper functioning of the vehicle’s electrical system. Regular inspection is especially important in cold weather. Be sure to have a MITSUBISHI MOTORS Authorized Service Point check the auxiliary battery.

WARNING

- Be sure to have a MITSUBISHI MOTORS Authorized Service Point charge the battery. Do not charge the battery yourself. Flammable gases may leak and explode.

CAUTION

- There is a type of auxiliary battery is not properly installed in the vehicle, even if the same specification.
When replacing the auxiliary battery, please contact a MITSUBISHI MOTORS Authorized Service Point.

NOTE

- When the auxiliary battery is removed, the controlling timer for forcibly starting the engine may be reset.
Since a fuel injection device may cause a clogging if the state where the engine does not operate continues after reset of the timer, please press the battery charge switch in order to start the engine. However, when the drive battery is near full charge, even if the battery charge switch is pressed, the engine may not start. In that case, press the battery charge switch again after the drive battery quantity decreases. Refer to “Battery charge switch” on page 7-23.
- When the auxiliary battery is removed, since the timer control of the MITSUBISHI Remote Control is reset and the drive battery temperature control can not be used, communicate the wireless LAN device and your vehicle again.
- When the auxiliary battery is removed, the timer control of the MITSUBISHI Remote Control is reset and each function of the MITSUBISHI Remote Control can not be used. Also the drive battery can not be warmed up.
Communicate the wireless LAN device and your vehicle again.

Tyres

E01001300255

WARNING

- **Driving with tyres that are worn, damaged or improperly inflated can lead to a loss of control or blow out of the tyres which can result in a collision with serious or fatal injury.**

Tyres

Tyre inflation pressures

E01001402726

Tyre size	Front	Rear
215/70R16 100H	2.4 bar (35 PSI) [240 kPa], 2.6 bar (38 PSI) [260 kPa]*	
225/55R18 98H	2.4 bar (35 PSI) [240 kPa], 2.6 bar (38 PSI) [260 kPa]*	

*: Above 160 km/h

Check the tyre inflation pressure of all the tyres while they are cold; if insufficient or excessive, adjust to the specified value. After the tyre inflation pressure has been adjusted, check the tyres for damage and air leaks. Be sure to put caps on the valves.

Wheel condition

E01001801970

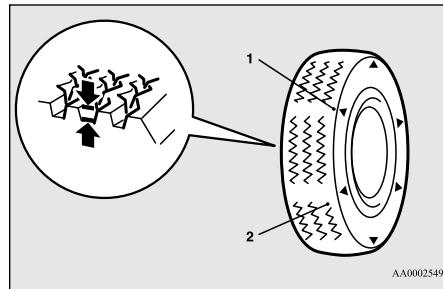

- 1- Location of the tread wear indicator
- 2- Tread wear indicator

Check the tyres for cuts, cracks and other damage. Replace the tyres if there are deep

cuts or cracks. Also check each tyre for pieces of metal or pebbles.

The use of worn tyres can be very dangerous because of the greater chance of skidding or hydroplaning. The tread depth of the tyres must exceed 1.6 mm in order for the tyres to meet the minimum requirement for use.

Tread wear indicators will appear on the surface of the tyre as the tyre wears, thereby indicating that the tyre no longer meets the minimum requirement for use. When these wear indicators appear, the tyres must be replaced with new ones.

When replacement of any of the tyres is necessary, replace all of them.

CAUTION

- Always use tyres of the same size, same type, and same brand, and which have no wear differences. Using tyres of different size, type, brands or degree of wear, will increase the differential oil temperature, resulting in possible damage to the driving system. Further, the drive train will be subjected to excessive loading, possibly leading to oil leakage, component seizure, or other serious faults.

Replacing tyres and wheels

E01007200243

⚠ CAUTION

- Avoid using different size tyres from the one listed and the combined use of different types of tyres, as this can affect driving safety. Refer to “Tyres and wheels” on page 12-8.
- Even if a wheel has the same rim size and offset as the specified type of wheel, its shape may prevent it from being fitted correctly. We recommend you to consult a specialist before using wheels that you have.

Tyre rotation

E01001902486

Tyre wear varies with vehicle conditions, road surface conditions and individual driver’s driving habits. To equalise the wear and help extend tyre life, it is recommended to rotate the tyres immediately after discovery of abnormal wear, or whenever the wear difference between the front and rear tyres is recognisable.

When rotating tyres, check for uneven wear and damage. Abnormal wear is usually caused by incorrect tyre pressure, improper wheel alignment, out of balance wheel, or severe braking. We recommend you to have it

checked to determine the cause of irregular tread wear.

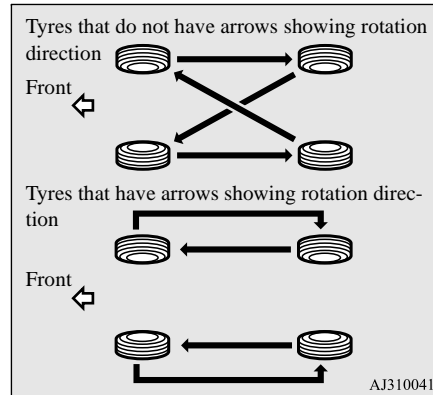

⚠ CAUTION

- If the tyres have arrows (A) indicating the correct direction of rotation, swap the front and rear tyres on the left-hand side of the vehicle and the front and rear tyres on the right-hand side of the vehicle separately. Keep each tyre on its original side of the vehicle. When fitting the tyres, make sure the arrows point in the direction in which the wheels will turn when the vehicle moves forward. Any tyre whose arrow points in the wrong direction will not perform to its full potential.

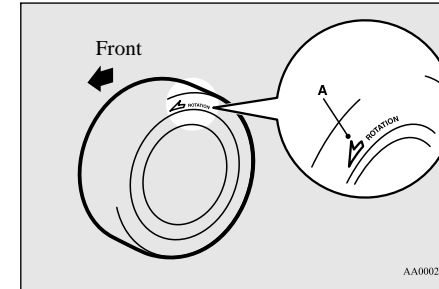

⚠ CAUTION

- Avoid the combined use of different types of tyres. Using different types of tyres can affect vehicle performance and safety.

Snow tyres

E01002000754

The use of snow tyres is recommended for driving on snow and ice. To preserve driving stability, mount snow tyres of the same size and tread pattern on all four wheels. A snow tyre that is worn down more than 50% is no longer appropriate to use. Snow tyres which do not meet specifications must not be used.

Wiper blade rubber replacement

⚠ CAUTION

- Observe permissible maximum speed for your snow tyres and the legal speed limit.

📖 NOTE

- The laws and regulations concerning snow tyres (driving speed, required use, type, etc.) vary. Find out and follow the laws and regulations in the area you intend to drive.
- If flange nuts are used on your vehicle, change to tapered nuts when steel wheels are used.

Always follow the chain manufacturer's instructions when fitting the chains.

⚠ WARNING

- **DO NOT use a jack when fitting the chains, as in the conditions, the tyres may slip on the icy road causing the vehicle to slip off the jack.**

⚠ CAUTION

- Choose a clear straight stretch of road where you can pull off and still be seen while you are fitting the chains.
- Do not fit chains before you need them. This will wear out your tyres and the road surface.
- After driving around 100-300 metres, stop and retighten the chains.
- Care should be taken with extremes of steering lock to prevent possible contact between the chains and the vehicle body.
- Drive carefully and do not exceed 30 km/h. Remember, fitting chains is not going to stop accidents from happening.
- When tyre chains are installed, take care that they do not damage the disc wheel or body.
- An aluminium wheel can be damaged by a tyre chain while driving. When fitting a tyre chain on an aluminium wheel, take care that any part of the chain and fitting cannot be brought into contact with the wheel.

⚠ CAUTION

- Remove the wheel covers before installing a tyre chain, otherwise they may be damaged by the tyre chain. (Refer to page 9-18.)
- When installing or removing the tyre chains, take care that hands and other parts of your body are not injured by the sharp edges of the vehicle body.
- Install the chains only on the front tyres and tighten them as tightly as possible with the ends securely fastened.

Wiper blade rubber replacement

E01002600532

Windscreen wiper blades

1. Lift the wiper arm off the windscreen.

Tyre chains

E01002101882

11

It is recommended that snow chains are carried in snow regions and fitted when required to the front wheels in accordance with the manufacturer's instructions.

On 4WD vehicles in which the driving power is distributed preferentially to the front wheels, ensure that the tyre chains are fitted on the front.

The tyres fitted to your vehicle as original equipment allow you to fit tyre chains if they are required. When replacing your tyres, check with the tyre distributor or manufacturer if the fitting of tyre chains will be detrimental to the tyres being purchased.

2. Pull the wiper blade until its stopper (A) disengages from the hook (B). Then, pull the wiper blade further to remove it.

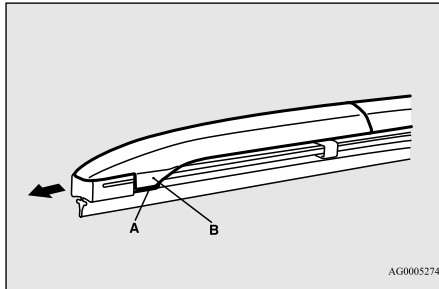

NOTE

- Do not allow the wiper arm to fall onto the windscreen; it could damage the glass.

3. Attach the retainers (C) to a new wiper blade. Refer to the illustration to ensure that the retainers are correctly aligned as you attach them.

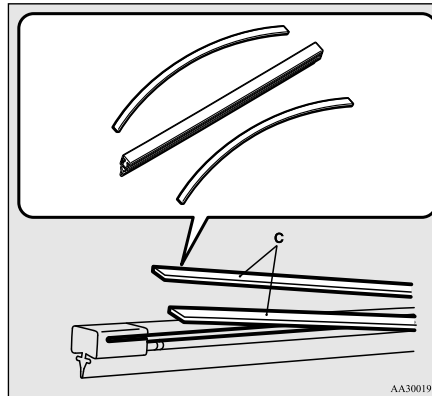

4. Insert the wiper blade into the arm, starting with the opposite end of the blade from the stopper. Make sure the hook (B) is fitted correctly in the grooves in the blade.

NOTE

- If retainers are not supplied with the new wiper blade, use the retainers from the old blade.

Wiper blade rubber replacement

5. Push the wiper blade until the hook (B) engages securely with the stopper (A).

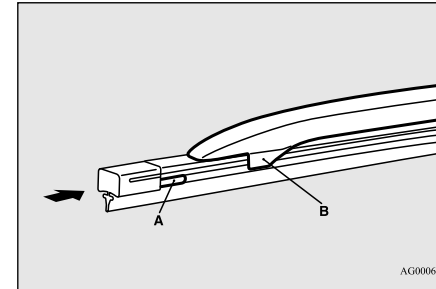

Rear window wiper blades

1. Lift the wiper arm off the window glass.
2. Pull the wiper blade downward to disengage it from the stopper (A) at the end of the wiper arm. Pull the wiper blade further to remove it.

General maintenance

3. Slide a new wiper blade through the hook (B) on the wiper arm.

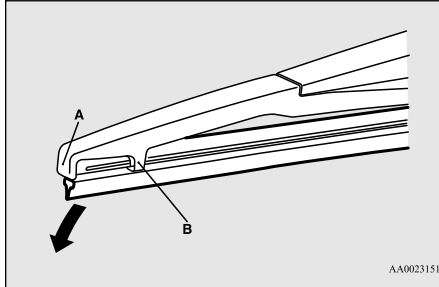

NOTE

- Do not allow the wiper arm to fall onto the windows glass; it could damage the glass.

11

4. Firmly insert the retainer (C) into the groove (D) in the wiper blade. Refer to the illustration to ensure that the retainers are correctly aligned as you insert them into the groove.

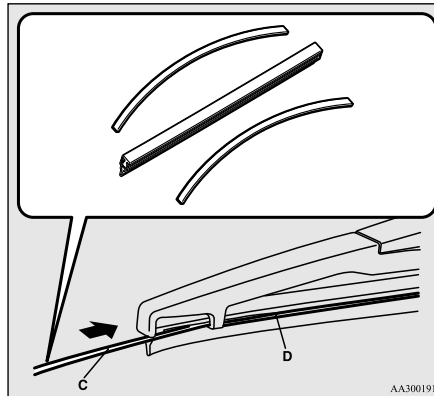

NOTE

- If a retainer is not supplied with the new wiper blade, use the retainer from the old blade.

General maintenance

E01002701556

Fuel, engine coolant, oil and exhaust gas leakage

Look under the body of your vehicle to check for fuel, engine coolant, oil and exhaust gas leaks.

WARNING

- If you see a suspicious fuel leak or if you smell fuel, do not operate the vehicle; call your MITSUBISHI MOTORS Authorised Service Point for assistance.

Exterior and interior lamp operation

Operate the combination lamp switch to check that all lamps are functioning properly. If the lamps do not illuminate, the probable cause is a blown fuse or defective lamp bulb. Check the fuses first. If there is no blown fuse, check the lamp bulbs.

For information regarding the inspection and replacement of the fuses and the bulbs, refer to "Fuses" on page 11-15 and "Replacement of lamp bulbs" on page 11-21.

If the fuses and bulbs are all OK, we recommend you to have your vehicle checked and repaired.

Meter, gauge and indicator/warning lamps operation

Start the plug-in hybrid EV system and check the operation of all instruments, gauges and indicator and warning lamps.

If there is anything wrong, we recommend you to have your vehicle inspected.

Hinges and latches lubrication

Check all latches and hinges, and, if necessary, have them lubricated.

Fusible links

E01002901633

The fusible links will melt to prevent a fire if a large current attempts to flow through certain electrical systems.

In case of a melted fusible link, we recommend you to have your vehicle inspected.

For the fusible links, please refer to “Passenger compartment fuse location table” on page 11-17 and “Engine compartment fuse location table” on page 11-18.

WARNING

- Fusible links must not be replaced by any other device. Failing to fit the correct fusible link may result in fire in the vehicle, property destruction and serious or fatal injuries at any time.

Fuses

E01003003332

Fuse block location

E01011800035

To prevent damage to the electrical system due to short-circuiting or overloading, each individual circuit is provided with a fuse.

There are fuse blocks in the passenger compartment and in the engine compartment.

Passenger compartment (LHD vehicles)

The fuse blocks in the passenger compartment are located behind the fuse lid in front of the driver’s seat at the position shown in the illustration.

Pull the fuse lid to remove it.

Fusible links

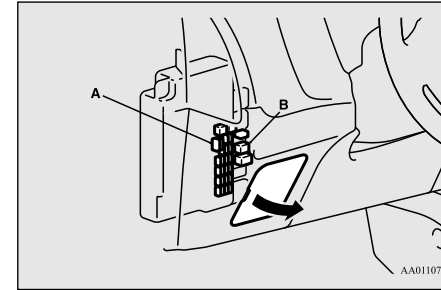

A- Main fuse block

B- Sub fuse block

Passenger compartment (RHD vehicles)

The fuse blocks in the passenger compartment are located behind the glove box at the position shown in the illustration.

11

Fuses

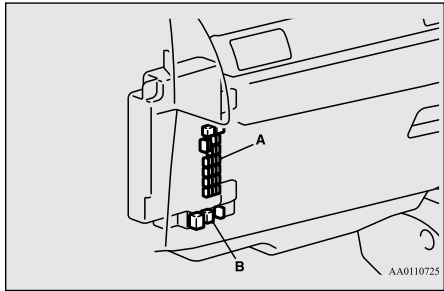

A- Main fuse block
B- Sub fuse block

Main fuse block

1. Open the glove box.
2. Uncouple the rod (A) on the right side of the glove box.

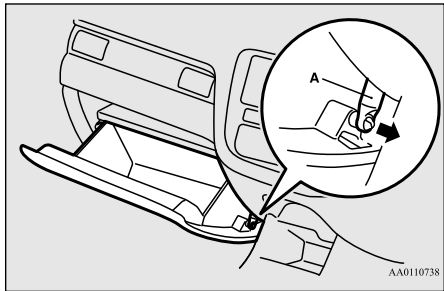

3. While pressing the side of the glove box, unhook the left and right hooks (B) and lower the glove box.

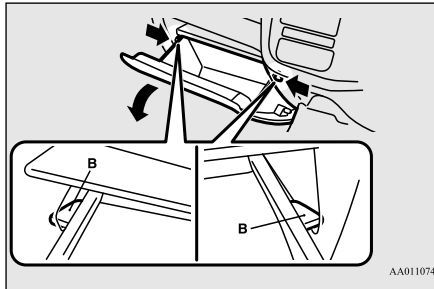

4. Remove the glove box fastener (C), and then remove the glove box.

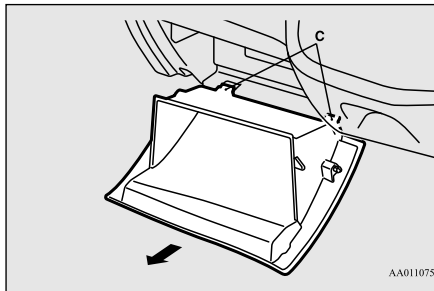

Sub fuse block

When changing the fuse of the sub fuse block, perform it with the hole of the bottom cover.

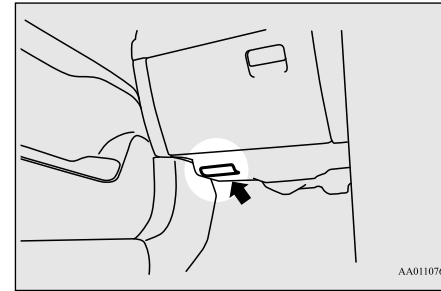

Engine compartment

E01011900023

In the engine compartment, the fuse block is located as shown in the illustration. While pressing the tab (C), pull up the cover.

Fuses

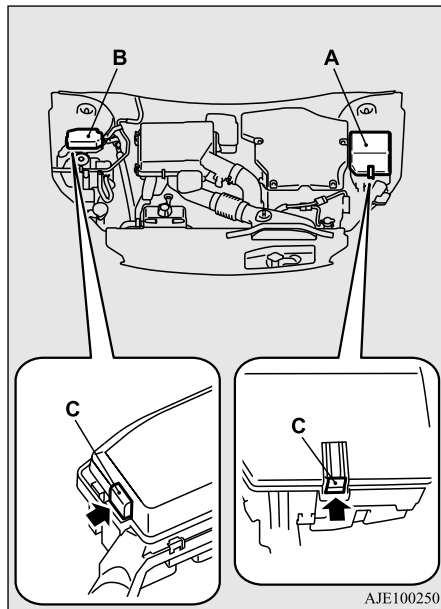

A- Main fuse block
B- Sub fuse block

AJE100250

Fuse load capacity

E01007701753

The fuse capacity and the names of electrical systems protected by the fuses are indicated on the inside of the fuse lid (LHD vehicles), the back side of the glove box (RHD vehi-

cles) and inside of the fuse block cover (inside of the engine compartment).

NOTE

- Spare fuses are provided on the cover of main fuse block in the engine compartment. Always use a fuse of the same capacity for replacement.

Passenger compartment fuse location table

E01007900790

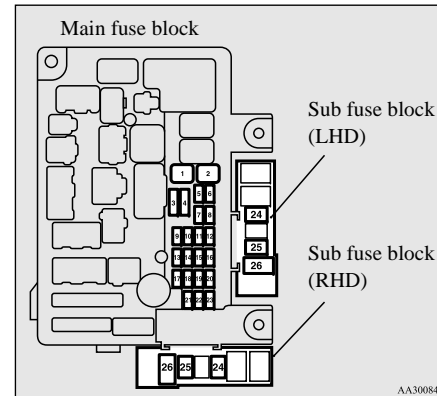

AA3008470

No.	Symbol	Electrical system	Capacity
1		Electric window control	30 A*
2		Rear window demister	30 A*
3		Heater	30 A
4		Windscreen wipers	30 A
5		Door locks	20 A
6		Rear fog lamp	10 A
7		Accessory socket	15 A
8		Rear window wiper	15 A
9		Sunroof	20 A
10		Ignition switch	10 A
11		Option	10 A
12		Hazard warning flasher	15 A
13		4-wheel drive system	10 A
14	STOP	Stop lamps (Brake lamps)	15 A
15		Instruments	10 A

Fuses

No.	Symbol	Electrical system	Capacity
16		SRS airbag	7.5 A
17		Radio	15 A
18		Control unit relay	7.5 A
19		Interior lamps (Room lamps)	15 A
20		Reversing lamps (Backup lamps)	7.5 A
21		Heated door mirror	7.5 A
22		Outside rear-view mirrors	10 A
23		Cigarette lighter/Accessory socket	15 A
24		Charge	7.5 A
25		Power seat	30 A*
26		Heated seat	30 A

11

*: Fusible link

● Some fuses may not be installed on your vehicle, depending on the vehicle model or specifications.

11-18 Maintenance

● The table above shows the main equipment corresponding to each fuse.

Engine compartment fuse location table

E01008001867

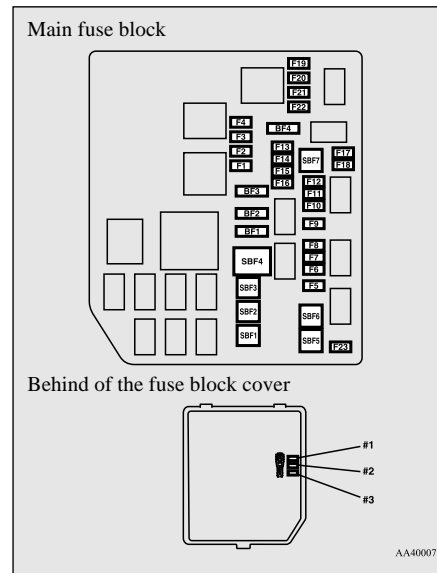

No.	Symbol	Electrical system	Capacities
SBF1		Air conditioning condenser fan motor	30 A*
SBF2	—	—	—
SBF3	—	—	—
SBF4		Radiator fan motor	40 A*
SBF5		Anti-lock braking system	40 A*
SBF6	—	—	—
SBF7		Anti-lock braking system	30 A*
BF1		Electric tailgate	30 A
BF2		Audio system amp	30 A
BF3		IOD	30 A
BF4	—	—	—
F1	—	—	—
F2		Wiper deicer	15A
F3	—	—	—
F4		Daytime running lamps	10 A
F5		Front fog lamps	15 A
F6	—	—	—

AA-4000732

Fuses

No.	Symbol	Electrical system	Capacities
F7		Headlamp washer	20 A
F8		Security horn	20 A
F9		Horn	10 A
F10		ETV	15 A
F11	—	—	—
F12		Engine	7.5 A
F13		ENG/POWER	20 A
F14		Fuel pump	15 A
F15		Ignition coil	10 A
F16	—	—	—
F17		Headlamp high beam (left)	10 A
F18		Headlamp high beam (right)	10 A
F19		Headlamp low beam (left)	Dis-charge 20 A

No.	Symbol	Electrical system	Capacities
F20		Headlamp low beam (right)	Dis-charge 20 A
F21		Headlamp low beam (left)	Halo-gen 10 A
F22		Headlamp low beam (right)	Halo-gen 10 A
F23	—	—	—
#1	—	Spare fuse	10 A
#2	—	Spare fuse	15 A
#3	—	Spare fuse	20 A

*: Fusible link



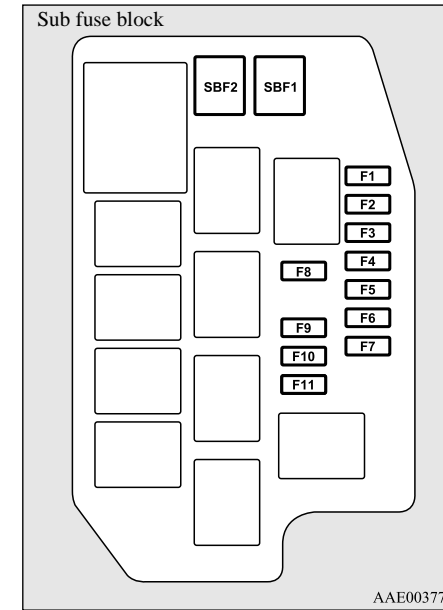



- Some fuses may not be installed on your vehicle, depending on the vehicle model or specifications.
- The table above shows the main equipment corresponding to each fuse.



11

No.	Symbol	Electrical system	Capacities
SBF1		Electrical Parking Lock	30 A*
SBF2		Vacuum pump (Regenerative brake)	30 A*
F1		Water pump (Electric motor)	20 A

Fuses

No.	Symbol	Electrical system	Capacities
F2	—	—	—
F3	—	—	—
F4		Fuel tank filler door	7.5 A
F5		Solenoid valve (Air conditioning)	7.5 A
F6		Water pump (Air conditioning)	7.5 A
F7		Electric motor unit control	10 A
F8	—	—	—
F9		Drive battery fan motor	15 A
F10		Ignition control	15 A
F11		Ignition control	7.5 A

11

*: Fusible link

- Some fuses may not be installed on your vehicle, depending on the vehicle model or specifications.
- The table above shows the main equipment corresponding to each fuse.

The fuse block does not contain spare 7.5 A or 30 A fuses. If one of these fuses burns out, substitute with the following fuse.

7.5 A: 10 A spare fuse

30 A: 30 A audio system amp fuse

When using a substitute fuse, replace with a fuse of the correct capacity as soon as possible.

Identification of fuse

E01008101389

Capacity	Colour
7.5 A	Brown
10 A	Red
15 A	Blue
20 A	Yellow
30 A	Green (fuse type) /Pink (fusible link type)
40 A	Green (fusible link type)

Fuse replacement

E01007801884

1. Before replacing a fuse, always turn off the electrical circuit concerned and put the operation mode of the power switch in OFF.

2. Remove the fuse puller (A) from the inside of the main fuse block cover in the engine compartment.

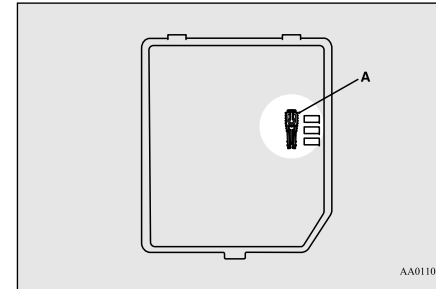

3. Referring to the fuse load capacity table, check the fuse pertaining to the problem.

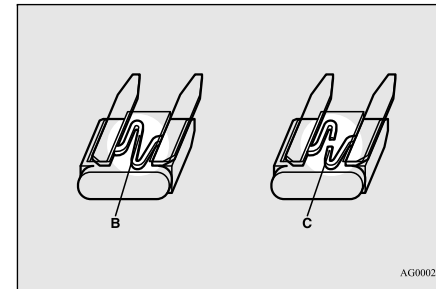

- B- Fuse is OK
C- Blown fuse

NOTE

- If any system does not function but the fuse corresponding to that system is normal, there may be a fault in the system elsewhere. We recommend you to have your vehicle checked.

4. Insert a new fuse of the same capacity by using the fuse puller into the same place in the fuse block.

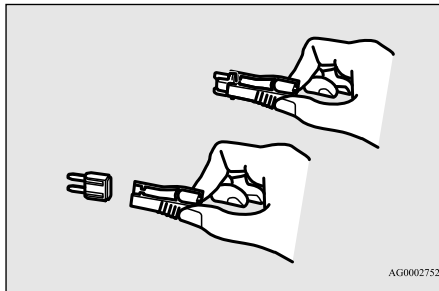

CAUTION

- If the newly inserted fuse blows again after a short time, we recommend you to have the electrical system checked to find the cause and rectify it.
- Never use a fuse with a larger capacity than specified or a substitute (such as a cable or foil). Doing so could cause the circuit wires to overheat and create a fire.

Replacement of lamp bulbs

E01003101805

Before replacing a bulb, ensure the lamp is off. Do not touch the glass part of the new bulb with your bare fingers; the skin oil left on the glass will evaporate when the bulb gets hot and the vapour will condense on the reflector and dim the surface.

CAUTION

- Bulbs are extremely hot immediately after being turned off. When replacing a bulb, wait for it to cool sufficiently before touching it. You could otherwise be burnt.
- Handle halogen lamp bulb with care. The gas inside a halogen lamp bulb is highly pressurized, so dropping, knocking, or scratching a halogen lamp bulb can cause it to shatter.
- Never hold the halogen lamp bulb with a bare hand, dirty glove, etc. The oil from your hand could cause the bulb to break the next time the headlamps are operated. If the glass surface is dirty, it must be cleaned with alcohol, paint thinner, etc., and refit it after drying thoroughly.

Replacement of lamp bulbs

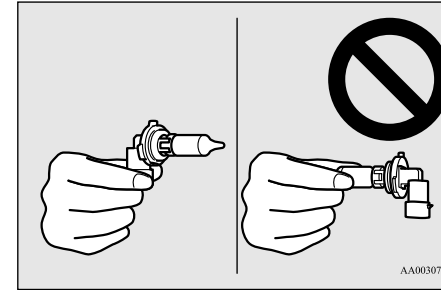

NOTE

- If you are unsure of how to carry out the work as required, we recommend you to consult a specialist.
- Be careful not to scratch the vehicle body when removing a lamp or lens.
- When it rains, or when the vehicle has been washed, the inside of the lens sometimes becomes foggy. This is the same phenomenon as when window glass mists up on a humid day, and does not indicate a functional problem. When the lamp is switched on, the heat will remove the fog. However, if water gathers inside the lamp, we recommend you to have the lamp checked.

Replacement of lamp bulbs

Bulb location and capacity

E01003200333

When replacing a bulb, use a new bulb with the same wattage and colour.

Outside

E01003304042

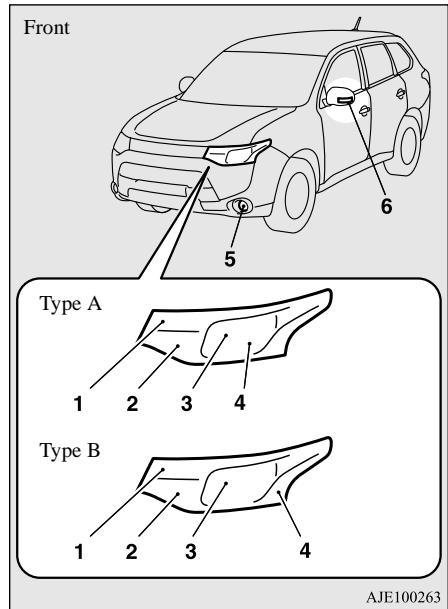

Type A: Except for high intensity discharge headlamp type

Type B: High intensity discharge headlamp type

- 1- Front turn-signal lamps: 21 W (PY21W)
- 2- Headlamps, high beam: 60 W (HB3)
- 3- Headlamps, low beam
Halogen: 55 W (H7)
High intensity discharge: 35 W
- 4- Position lamps: 5 W (W5W)
- 5- Front fog lamps: 55 W (H11)
- 6- Side turn-signal lamps

Codes in parentheses indicate bulb types.

WARNING

- Always consult a specialist when repairing or replacing the bulbs of high intensity discharge headlamps. This is because the power circuit, bulbs and electrodes generate a high voltage that could cause an electric shock.

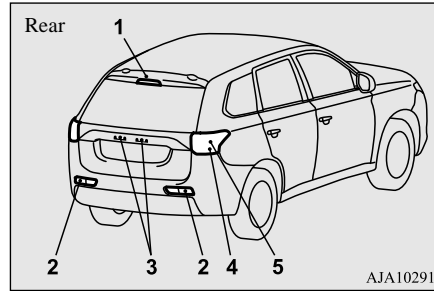

- 1- High mounted stop lamp
- 2- Reversing lamps: 21 W (W21W)
- 3- Licence plate lamps: 5 W (W5W)
- 4- Rear turn-signal lamps: 21 W (PY21W)
- 5- Stop and tail lamps

Codes in parentheses indicate bulb types.

NOTE

- The following lamps are not possible to repair or replace only the bulb. If you need to repair or replace these lamp bulbs, contact a MITSUBISHI MOTORS Authorised Service Point.
 - Side turn- signal lamps
 - High mounted stop lamp
 - Stop and tail lamps

Inside

E01003401912

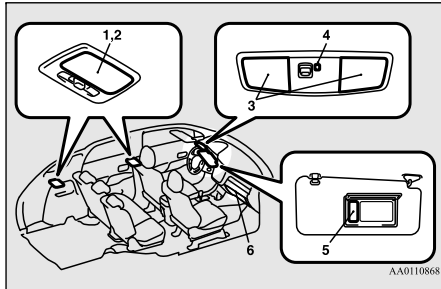

- 1- Luggage room lamp: 8 W
- 2- Room lamp (rear): 8 W
- 3- Map & room lamps (front): 8 W
- 4- Downlight
- 5- Vanity mirror lamps: 2 W
- 6- Glove box lamp: 1.4 W

NOTE

- An LED, not a bulb, is used in the downlight. Contact a MITSUBISHI MOTORS Authorised Service Point when there is a need for repair or replacement.

Headlamps (low beam, halogen bulb)

E01009301421

1. When replacing the bulb on the left side of the vehicle, remove the bolt (A) holding down the relay box and move the relay box.

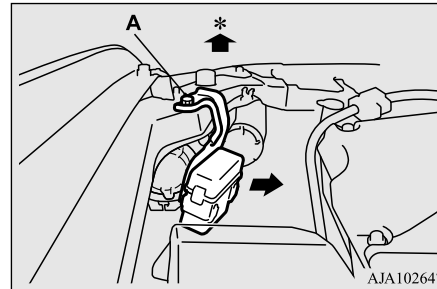

*: Front of the vehicle

Replacement of lamp bulbs

2. Turn the cap (B) anticlockwise to remove it.

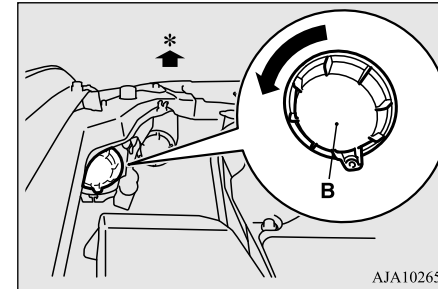

*: Front of the vehicle

3. Turn the socket (C) anticlockwise to remove it, and then pull the bulb out of the socket.

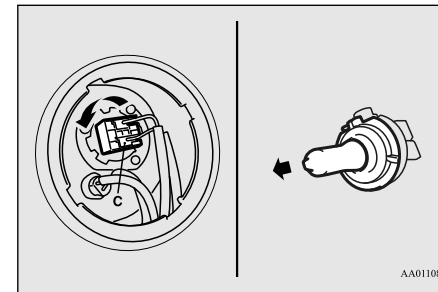

4. To install the bulb, perform the removal steps in reverse.

Replacement of lamp bulbs

Headlamps (high beam)

E01009401246

1. When replacing the bulb on the right side of the vehicle, remove the clip (A) holding down the washer tank and move the washer tank.

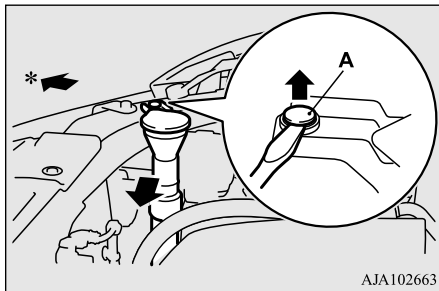

*: Front of the vehicle

11

2. Turn the cap (B) anticlockwise to remove it.

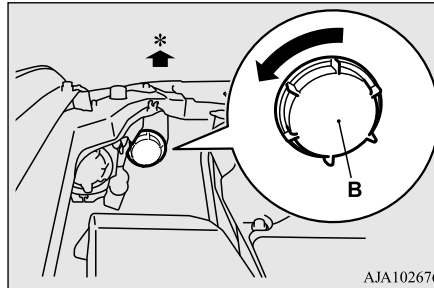

*: Front of the vehicle

3. Turn the bulb (C) anticlockwise to remove it, and then while holding down the tab (D), pull out the connector (E).

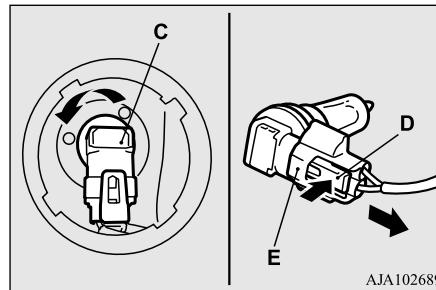

4. To install the bulb, perform the removal steps in reverse.

Position lamps

E01003702231

When replacing the bulb on the left side of the vehicle, move the relay box. (Refer to "Headlamps (low beam, halogen bulb): Step 1" on page 11-23)

Except for vehicles equipped with high intensity discharge headlamps

1. Turn the cap (A) anticlockwise to remove it.

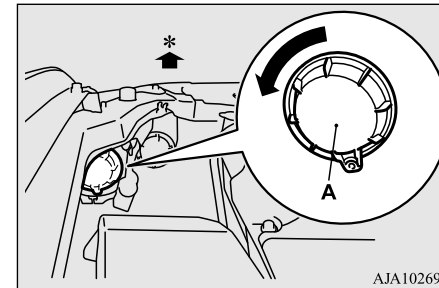

*: Front of the vehicle

2. Pull out the socket (B), and then pull the bulb out of the socket.

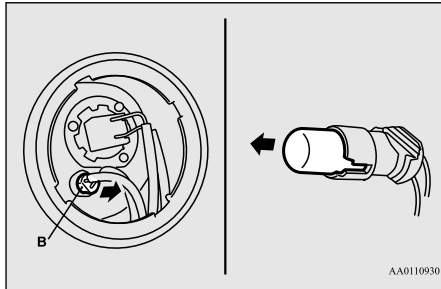

3. To install the bulb, perform the removal steps in reverse.

Vehicles equipped with high intensity discharge headlamps

1. Turn the socket (A) anticlockwise to remove it, and then pull the bulb out of the socket.

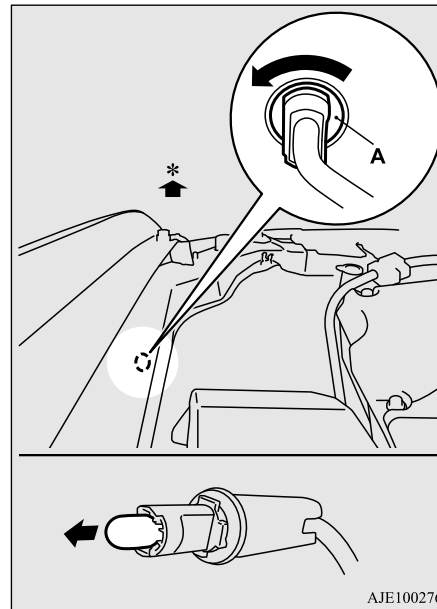

*: Front of the vehicle

2. To install the bulb, perform the removal steps in reverse.

Replacement of lamp bulbs

Front turn-signal lamps

E01003802199

1. Turn the socket (A) anticlockwise to remove it, then remove the bulb from the socket by turning it anticlockwise while pressing in.

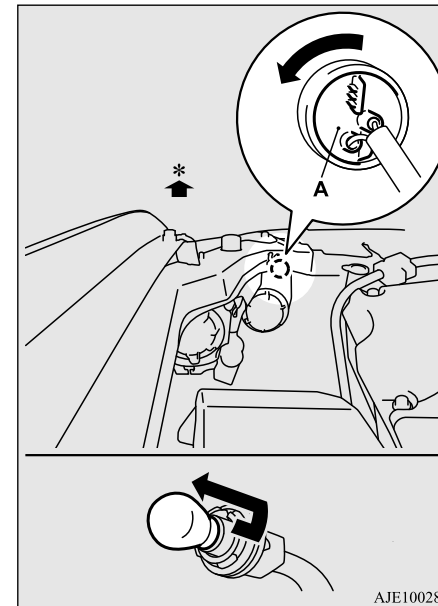

*: Front of the vehicle

2. To install the bulb, perform the removal steps in reverse.

Replacement of lamp bulbs

Front fog lamps

E01004002808

1. Insert a straight blade (or minus) screwdriver with a cloth over its tip at the edge of the cover (A) and pry gently to remove the cover.

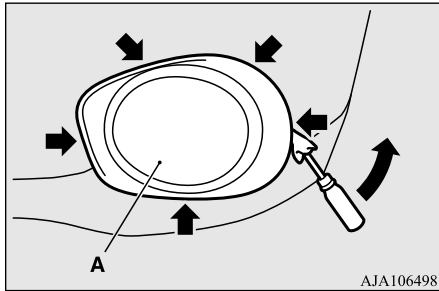

AJA106498

11

2. Remove the 3 screws (B) and remove the lamp unit.

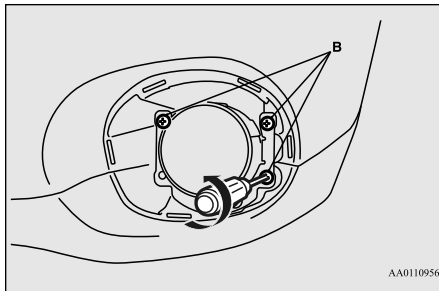

AA0110956

NOTE

- When unfastening the screws of the fog lamp, be careful not to mistakenly move the beam position adjustment screw (C).

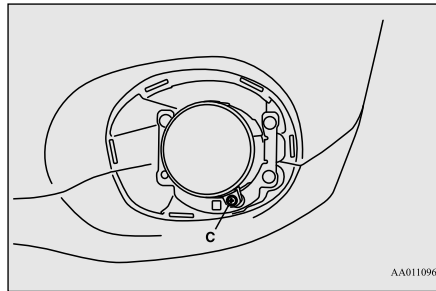

AA0110969

3. Turn the bulb (D) anticlockwise to remove it, and then while holding down the tab (E), pull out the connector (F).

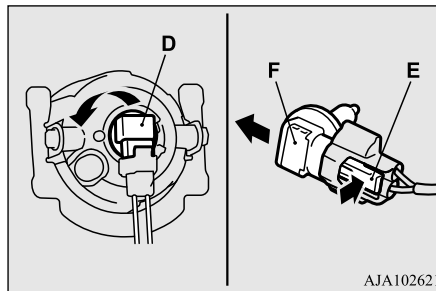

AJA102621

4. To install the bulb, perform the removal steps in reverse.

Reversing lamps

E01004401401

1. Push the lamp unit toward the centre of the vehicle body to remove it.

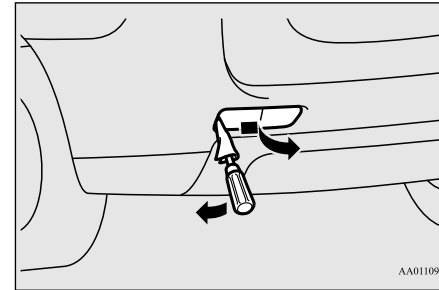

AA0110985

2. Turn the socket (A) anticlockwise to remove it, and then pull the bulb out of the socket.

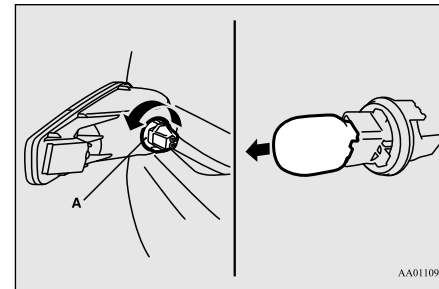

AA0110998

Replacement of lamp bulbs

3. To install the bulb, perform the removal steps in reverse.

NOTE

- When installing the lamp unit, first insert the notch (B) into the hole on the body, and then push on the lamp unit to fit it into place.

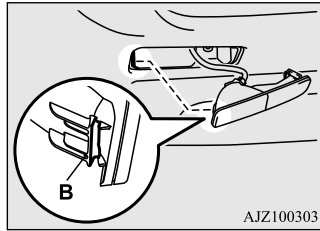

Rear combination lamps

E01004202549

1. Open the tailgate.

2. Remove the screws (A), and then move the lamp unit towards the rear of the vehicle to unfix the notch (B) and pins (C) of the lamp unit.

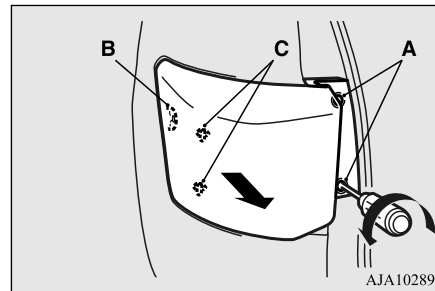

3. Turn the socket anticlockwise and remove it, and then remove the bulb from the socket by turning it anticlockwise while pressing in.

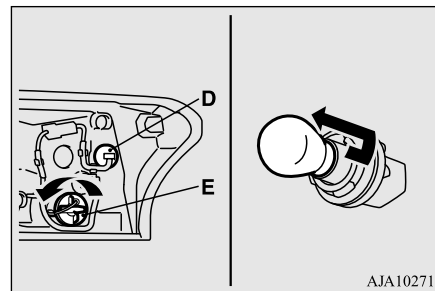

D- Stop and tail lamp (LED) - Cannot be replaced

E- Rear turn- signal lamp

4. To install the bulb, perform the removal steps in reverse.

NOTE

- When installing the lamp unit, align the notch (F) and pins (G) on the lamp unit with the clip (H) and holes (I) in the body.

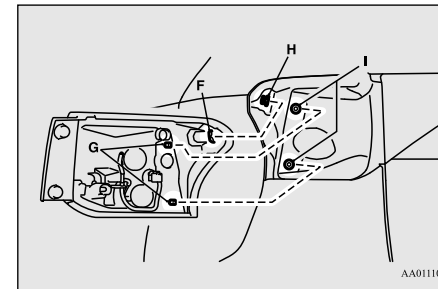

Replacement of lamp bulbs

Licence plate lamps

E01004600679

1. Remove while pressing the lamp unit (A) to the left side of the vehicle.

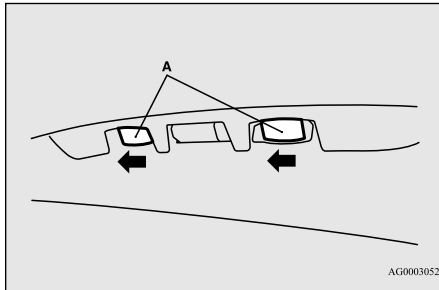

2. Insert a minus screwdriver with the end covered with a cloth or other object to press the hook (B) aside and remove the lens.

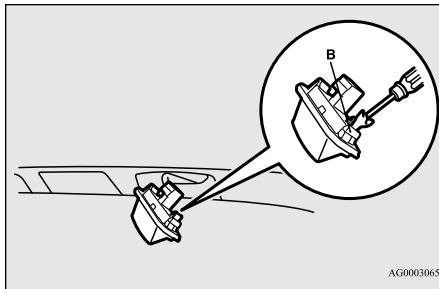

3. Remove the bulb from the socket.

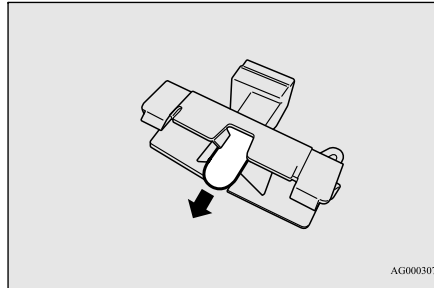

4. To install the bulb, perform the removal steps in reverse.

NOTE

- When installing the lamp unit, first insert the end of tab (C) and then align tab (D).

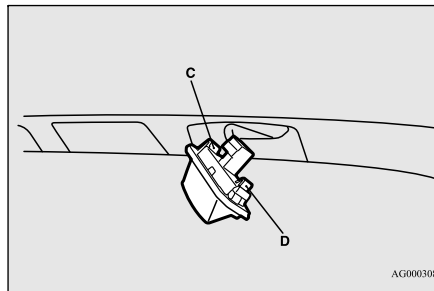

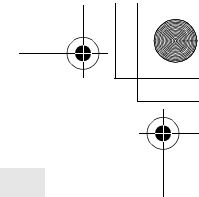
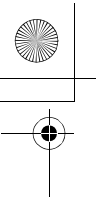

Specifications

Vehicle labeling	12-2
Vehicle dimensions	12-4
Vehicle performance	12-5
Vehicle mass	12-5
Engine specifications	12-6
Charging system specifications	12-7
Electric motor specifications	12-8
Low voltage electrical system	12-8
Tyres and wheels.....	12-8
Other specifications	12-9
Refill capacities	12-10

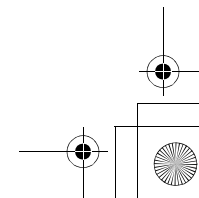
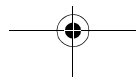
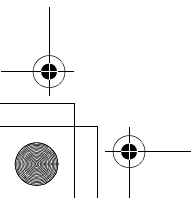
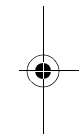
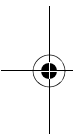

Vehicle labeling

Vehicle labeling

E01100104372

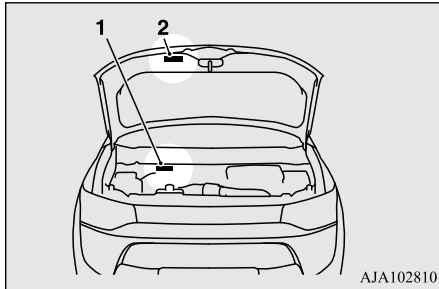

AJA102810

- 1- Vehicle identification number: (VIN)
- 2- Vehicle information code plate

Vehicle identification number: (VIN)

12

The vehicle identification number is stamped on the bulkhead as shown in the illustration.

Vehicle information code plate

The plate shows the model code, engine model, transaxle model and body colour code, etc.

Please use this number when ordering replacement parts.

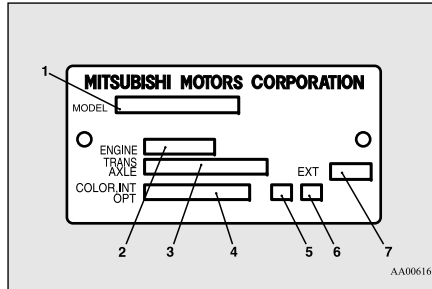

AA0061612

- 1- Model code
- 2- Engine model code
- 3- Transaxle model code
- 4- Body colour code
- 5- Interior code
- 6- Option code
- 7- Exterior code

Vehicle data label

The vehicle data label is located as shown in the illustration.

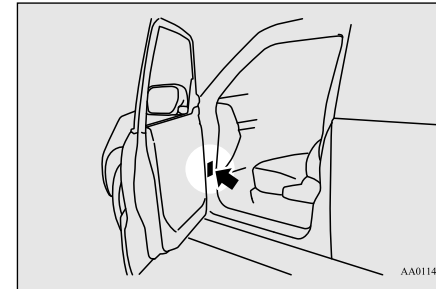

AA0114521

In all correspondence related to your vehicle or when purchasing spare parts, the following information should be quoted:

- The engine number — see details on following page.
- The vehicle identification number (V.I.N.). — see details on previous page.
- The S.O.A. No. (where applicable), the option codes, paint and trim codes — located on the Data Label.

12-2 Specifications

Vehicle labeling

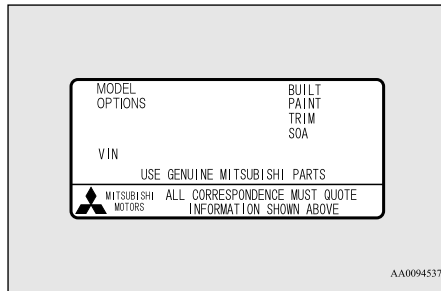

Compliance label

The compliance label is located as shown in the illustration.

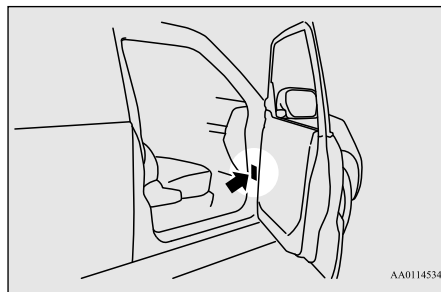

The compliance label certifies that your vehicle complies with Australian Design Rules at the time of manufacture.

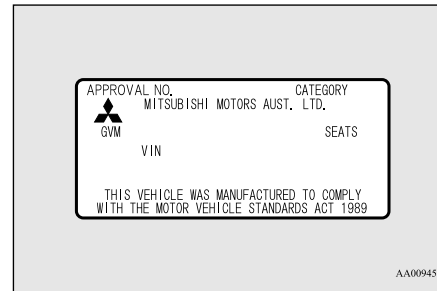

Engine number

The engine number is stamped on the engine cylinder block as shown in the illustration.

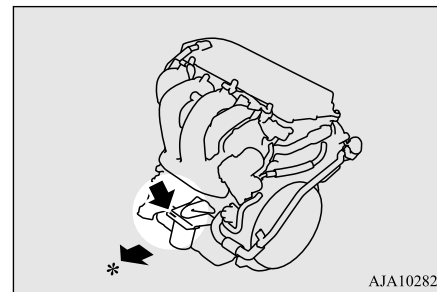

*: Front of the vehicle

Electric motor number

The electric motor number is stamped as shown in the illustration.

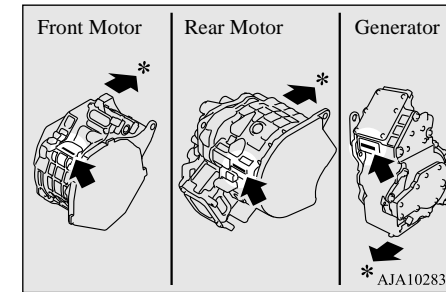

*: Front of the vehicle

Vehicle dimensions

Vehicle dimensions

E01100203956

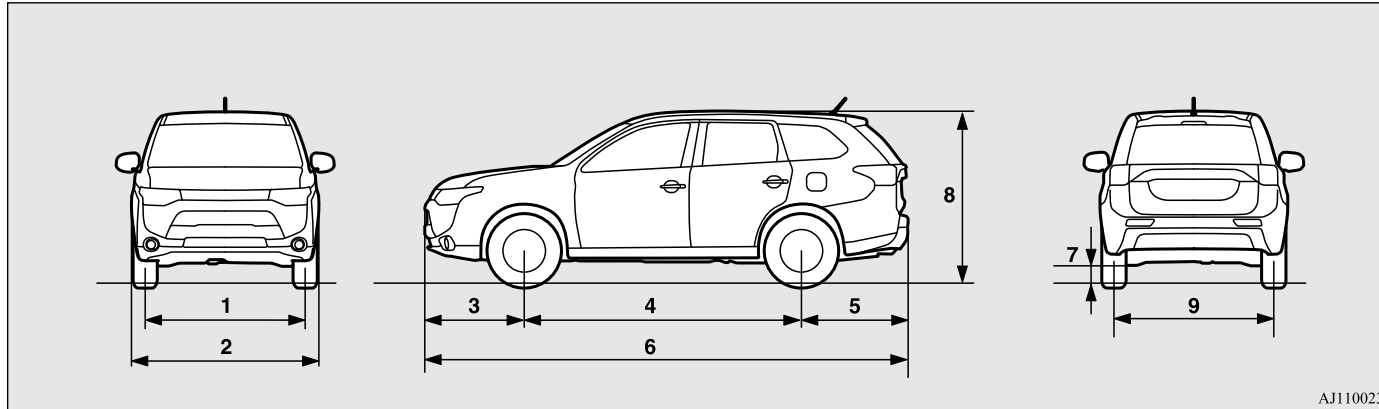

AJ1100234

12

1	Front track		1,540 mm
2	Overall width		1,810 mm
3	Front overhang		955 mm
4	Wheel base		2,670 mm
5	Rear overhang		1,030 mm
6	Overall length		4,655 mm
7	Ground clearance (unladen)		190 mm
8	Overall height (unladen)	Without roof rails	1,680 mm
		With roof rails	
9	Rear track		1,540 mm

12-4 Specifications

Vehicle performance

Minimum turning radius	Body	5.73 m
	Wheel	5.3 m

Vehicle performance

E01100303540

Maximum speed	170 km/h
---------------	----------

Vehicle mass

E01100501740

Kerb mass	Without optional parts	1,810 kg
	With full optional parts	1,871 kg
Maximum gross vehicle mass		2,310 kg
Maximum axle mass	Front	1,160 kg
	Rear	1,255 kg
Maximum towable mass	With brake	1,500 kg
	Without brake	750 kg
Maximum trailer-nose mass		150 kg
Maximum roof load		80 kg
Maximum gross combination mass		3,810 kg
Seating capacity		5 persons

12

NOTE

- Towing capacity and tow ball load are when fitted with a MITSUBISHI MOTORS Genuine Parts tow bar. The capacity may be reduced if a non MITSUBISHI MOTORS Genuine Parts tow bar is fitted. For further information when towing, including warranty coverage, refer to the section entitled "Towing caravans and trailers" on page 7-71.

Engine specifications

NOTE

- When loading luggage and/or towing trailer, make sure not to exceed any of the above maximum mass all the time.
- The vehicle kerb mass specified may vary depending on the equipment installed to the vehicle.

Engine specifications

E01100603934

Engine type	Four-cylinder, in line, water-cooled four-cycle, double overhead cam-shaft
Engine model	4B11
Total displacement	1,998 cc
Bore	86.0 mm
Stroke	86.0 mm
Compression ratio	10.5
Firing order	1-3-4-2

Charging system specifications

Charging system specifications

E01101901044

Normal charging system	Rated input voltage		AC 240V (single phase)
	Rated input frequency		50 Hz/60 Hz
	Maximum rated current		10 A* ¹
	Maximum power consumption		3.6 kVA* ²
	Applicable standards	Charging cable (with connector and control box)	EN61851-1 EN61851-21 IEC61851-1 IEC61851-21 IEC62196-1 HD21.13 HD22.4
		On board charger	EN61851-1 EN61851-21 IEC61851-1 IEC61851-21
	Leakage current sensitivity in cable control box		20 mA
Charging mode		Based on IEC61851-1 Mode 2/Case B* ¹ Mode 3/Case C* ²	

*1. When using a genuine charging cable with control box

*2. When using a home or public charging device (EVSE: Electric Vehicles Supply Equipment)

Electric motor specifications

Normal charging system	IP degrees	IP44: When a charge connector is connected IP55: When charging lid is closed and vehicle is moving
------------------------	------------	---

Electric motor specifications

E01100603947

Item	Front Motor	Rear Motor
Electric motor model	S61	Y61
Maximum output (ECE net)	60 kW	
Maximum torque	137 N•m	195 N•m
Maximum 30 minutes power	25 kW	

Low voltage electrical system

E01100803747

12

Voltage	12 V	
Auxiliary battery	Type (JIS)	S46B24L(S)
	Capacity (5HR)	36 Ah
Spark plug type	NGK	DIFR5C11

Tyres and wheels

E01100904211

Tyre	215/70R16 100H		225/55R18 98H	
Wheel	Size	16x6 1/2JJ		18x7J
	Offset	38 mm		

Other specifications

 **NOTE**

- Contact your MITSUBISHI MOTORS Authorised Service Point for details on the combination used on your vehicle.

Other specifications

E01101002185

Fuel system	Fuel control	Electric controlled injection
	Fuel pump	Electric motor type
Steering system		Rack and pinion type, power assisted
Suspension	Front	Independent type, MacPherson strut, coil spring
	Rear	Independent type, multi-link, coil spring
Service brakes	Type	Hydraulic, dual diagonal circuit with power assistance, anti-lock brake system with electronic brake force distribution function and regenerative brake system
	Front	Ventilated disc brakes
	Rear	Disc brakes
Parking brakes		Parking brake acts mechanically on rear wheels

12

 **NOTE**

- Your vehicle cannot be run on L.P.G. (Liquid Petroleum Gas).

Refill capacities

Refill capacities

E01101305642

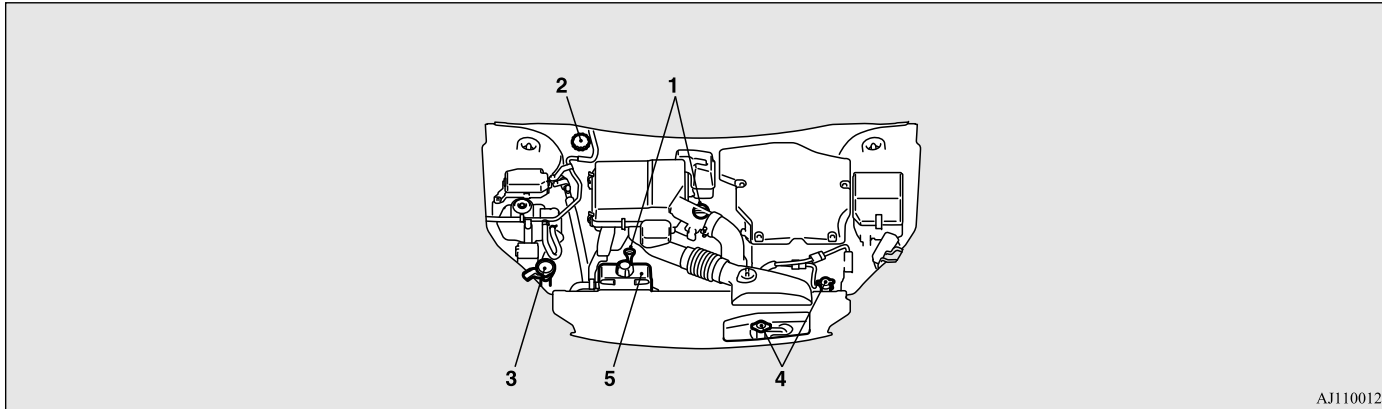

AJ1100120

12

No.	Item		Quantity	Lubricants	
1	Engine oil	Petrol-powered vehicles	Oil pan	4.3 litres	Refer to page 11-5
			Oil filter	0.3 litre	
2	Brake fluid		As required	Brake fluid DOT 3 or DOT 4	
3	Washer fluid		4.5 litres	—	
4	Engine coolant [includes 0.65 litre in the reserve tank]	Except for vehicles with electric heater	7.5 litres	MITSUBISHI MOTORS GENUINE SUPER LONG LIFE COOLANT PREMIUM or equivalent*	
		Vehicles with electric heater	9.0 litres		
5	Rear Motor coolant [includes 1.07 litre in the reserve tank]		6.5 litres		

Refill capacities

No.	Item	Quantity	Lubricants
6	Front Motor fluid	2.2 litres	MITSUBISHI MOTORS GENUINE CVTF-J4
7	Transaxle fluid	Front	MITSUBISHI MOTORS GENUINE ATF SP III
		Rear	

CAUTION

- For the transaxle fluid, use only the MITSUBISHI MOTORS GENUINE ATF.
Use of a different fluid could damage the transaxle.

No.	Item	Quantity	Lubricants
8	Refrigerant (air conditioner)	570 - 610 g	HFC-134a

*: Similar high quality ethylene glycol based non-silicate, non-amine, non-nitrate and non-borate coolant with long life hybrid organic acid technology

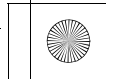
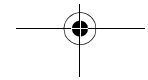
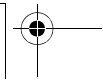
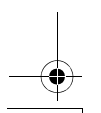
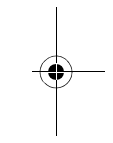
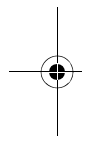
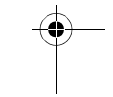
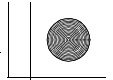
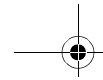
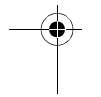
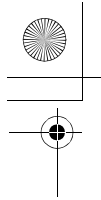

Alphabetical index

Numerics

4-wheel drive operation 7-20

A

Accessory (Installation) 2-14

Accessory socket 8-66

Active stability control (ASC) 7-32

Adaptive Cruise Control System (ACC) 7-43

Air conditioner

Automatic climate control air conditioner.
8-4

Important operation tips for the air condi-
tioner 8-11

Air purifier 8-12

Airbag 5-21

AM/FM radio 8-12

Antenna 8-40

Anti-lock brake system (ABS) 7-29

Ashtray 8-65

Assist grips 8-72

Audio

AM/FM radio 8-12

CD player 8-12

To listen to a disc in the rear-seat display .
8-34

Troubleshooting 8-38

Automatic transmission

Fluid 12-10

Auxiliary battery 11-8

Auxiliary battery charge warning lamp . 6-39

B

Battery

Auxiliary battery charge warning lamp
6-39

Discharged battery (Emergency starting) ..
9-2

Specification 12-8

Battery charge switch 7-23

Battery save switch 7-22

Bluetooth® 2.0 interface 8-41

Bonnet 11-3

Bottle holders 8-71

Brake

Anti-lock brake 7-29

Braking 7-26

Fluid 11-7, 12-10

Parking brake 7-4

Brake assist system 7-28

Brake warning lamp 6-37

Bulb capacity 11-22

C

Capacities 12-10

Card holder 8-65, 8-69

Cargo area cover 8-71

Cargo loads 7-70

Catalytic converter 11-3

Cautions on the handling of 4-wheel drive
vehicles 7-22

CD player 8-12

Central door locks 4-15

Charging indicator 6-37

Check engine warning lamp 6-38

Child restraint 5-15

Child restraint anchorage points 5-16

Child-protection rear doors 4-15

Cleaning

Exterior of your vehicle 10-3

Interior of your vehicle 10-2

Clutch

Fluid 12-10

Coat hook 8-72

Combination headlamps and dipper switch ...
6-40

Compliance label 12-3

Coolant (engine) 11-6, 12-10

Coolant (plug-in hybrid EV system) 11-6

Corner sensor 7-63

Cruise control 7-35

Cup holder 8-70

Alphabetical index

D

Daytime running lamps
 Bulb capacity 11-22

Demister (rear window)..... 6-53

Digital clock
 Time setting 8-36

Dimensions 12-4

Dipper (High/Low beam change) 6-42

Doors
 Central door locks 4-15
 Child-protection 4-15
 Lock and unlock 4-14

Driving, alcohol and drugs..... 7-2

E

Economical driving 7-2

Electric motor number..... 12-3

Electric power steering system (EPS) ... 7-32

Electric tailgate 4-17

Electric window control 4-29

Electrical Parking switch 7-16

Electronic immobilizer (Anti-theft starting system) 4-3

Emergency starting 9-2

Emergency stop signal system 7-29

Engine

13-2

Coolant 11-6, 12-10

Number 12-3

Oil 11-5

Oil and oil filter 12-10

Overheating 9-4

Safety and disposal information for used engine oil 2-15

Specifications 12-6

Exterior and interior lamp operation.... 11-14

F

Floor mat..... 7-3

Fluid
 Automatic transmission fluid..... 12-10
 Brake fluid 11-7, 12-10
 Clutch fluid 12-10
 CVT fluid 12-10
 Engine coolant 11-6, 12-10
 Plug-in hybrid EV system coolant.... 11-6
 Washer fluid 11-7, 12-10

Fluid capacities and lubricants 12-10

Forward Collision Mitigation System (FCM) 7-55

Front fog lamp indicator lamp 6-37

Front fog lamps
 Bulb capacity..... 11-22
 Replacement..... 11-26
 Switch..... 6-46

Front room lamp 8-67
 Bulb capacity..... 11-23

Front seats..... 5-3

Front turn-signal lamps
 Bulb capacity 11-22
 Replacement 11-25

Fuel
 Filling the fuel tank..... 2-13
 Fuel selection 2-12
 Modification/alterations to the electrical or fuel systems 2-15
 Tank capacity 2-13

Fuel-filled container..... 2-16

Fuses 11-15

Fusible links..... 11-15

G

General maintenance..... 11-14

General vehicle data..... 12-4

Genuine parts 2-15

Glove box lamp
 Bulb capacity 11-23

H

Hazard warning flasher switch 6-45

Hazard warning indicator lamps 6-36

Head restraints..... 5-5

Headlamp levelling..... 6-44

Headlamp washer switch 6-52

Alphabetical index

Headlamps
 Bulb capacity 11-22
 Headlamp flasher 6-42
 Replacement 11-23, 11-24
 Switch 6-40
 Heated mirror 7-9
 Heated seats 5-4
 Heating 8-12
 High mounted stop lamp 11-22
 Hill start assist 7-27
 Hinges and latches lubrication 11-15
 Horn switch 6-54

I

If the vehicle breaks down 9-2
 Indicator lamps 6-36
 Information screen display 6-39
 Inside rear-view mirror 7-6
 Inside tailgate release 4-24
 Inspection and maintenance following rough road operation 7-21
 Instruments 6-2
 Interior lamps 8-66

J

Jack 9-7
 Storage 9-6

Jump starting (Emergency starting) 9-2

K

Keyless entry system 4-3
 Keyless operation system 4-6
 Keys 4-2

L

Labeling 12-2
 Lamp monitor buzzer 6-42
 Lane Departure Warning (LDW) 7-60
 Leakage (Fuel, engine coolant, oil and exhaust gas) 11-14
 Licence plate lamps
 Bulb capacity 11-22
 Replacement 11-28
 Link System 8-40
 Low voltage electrical system 12-8
 Lubricants 12-10
 Luggage hooks 8-73
 Luggage room lamp 8-68
 Bulb capacity 11-23

M

Making a flat seat 5-8
 Making a luggage area 5-7

Manual transmission oil 12-10
 Map lamps 8-67
 Bulb capacity 11-23
 Mass 12-5
 Meter illumination control 6-2
 Mirror
 Inside rear-view mirror 7-6
 Outside rear-view mirror 7-7
 Modification/alterations to the electrical or fuel systems 2-15
 Multi information display 6-3

O

Oil
 Engine oil 11-5, 12-10
 Manual transmission oil 12-10
 Rear differential oil 12-10
 Transfer oil 12-10
 Operation under adverse driving conditions .. 9-22
 Other specifications 12-9
 Outside rear-view mirrors 7-7
 Overheating 9-4

P

Parking 7-5
 Parking brake 7-4
 Plug-in hybrid EV system

Alphabetical index

Coolant..... 11-6
 Plug-in Hybrid EV System warning lamp.....
 6-39
 Position lamps
 Bulb capacity 11-22
 Replacement 11-24
 Power switch..... 7-10
 Precautions to observe when using wipers and
 washers..... 6-53
 Pregnant women restraint 5-14
 Puncture
 Tyre repair kit 9-7

R

Ready indicator 6-37
 Rear combination lamps
 Bulb capacity 11-22
 Replacement 11-27
 Rear differential oil..... 12-10
 Rear fog lamp
 Indicator lamp 6-37
 Switch 6-47
 Rear room lamp 8-67
 Bulb capacity 11-23
 Rear turn-signal lamps
 Bulb capacity 11-22
 Replacement 11-27
 Rear window demister switch 6-53

13-4

Rear-view camera 7-67
 Rear-view mirror
 Inside 7-6
 Outside 7-7
 Refill capacities 12-10
 Regenerative braking level selector (paddle).
 7-17
 Replacement of lamp bulbs 11-21
 Reversing lamps
 Bulb capacity 11-22
 Replacement 11-26
 Reversing sensor system 7-63
 Roof carrier precaution 7-70
 Room lamp..... 8-67

S

Safe driving techniques..... 7-4
 Safety and disposal information for used
 engine oil 2-15
 S-AWC (Super All Wheel Control)..... 7-18
 Seat
 Adjustment 5-2
 Front seats 5-3
 Head restraints 5-5
 Heated seats..... 5-4
 Making a flat seat 5-8
 Making a luggage area 5-7
 Seat belt

Adjustable seat belt anchor 5-12
 Force limiter 5-15
 Inspection 5-21
 Pregnant women restraint 5-14
 Pre-tensioner 5-14
 Seat belt reminder 5-11
 Seat belts 5-9
 Child restraint 5-15
 Seats
 Rear seats 5-5
 Security alarm system 4-24
 Select Position indicator 7-15
 Selector Lever (Joystick Type)..... 7-14
 Service precaution 11-2
 Side turn-signal lamps
 Bulb capacity 11-22
 Snow tyres 11-11
 Spark plug..... 12-8
 Specifications 12-2
 Speed Limiter..... 7-39
 Spray can 2-16
 Starting and stopping the Plug-in Hybrid EV
 System..... 7-12
 Steering
 Steering wheel height adjustment 7-6
 Stop lamps
 Bulb capacity 11-22
 Replacement 11-27

Alphabetical index

Stopping the Plug-in Hybrid EV System 7-12
 Storage spaces 8-68
 Sun visors 8-64
 Sunroof 4-31
 Supplemental restraint system 5-21
 Servicing 5-30
 System check screen 6-12

T

Tail lamps
 Bulb capacity 11-22
 Replacement 11-27
 Tailgate 4-16
 Taking your vehicle overseas 2-16
 Tank capacity 2-13
 Time Setting 8-36
 Tools 9-7
 Storage 9-6
 Towing 9-19
 Towing caravans and trailers 7-71
 Transfer oil 12-10
 Turn/Lane-change signals 6-45
 Turn-signal indicator lamps 6-36
 Tyre repair kit 9-7
 Tyres 11-9
 How to change a tyre 9-14
 Inflation pressures 11-10

Rotation 11-11
 Size (tyre and wheel) 12-8
 Snow tyres 11-11
 Tread wear indicators 11-10
 Tyre chains 11-12
 Tyre repair kit 9-7

U

USB input terminal 8-61
 How to connect a USB memory 8-61
 How to connect an iPod 8-62

V

Vanity mirror lamp
 Bulb capacity 11-23
 Vehicle data label 12-2
 Vehicle care precautions 10-2
 Vehicle dimensions 12-4
 Vehicle identification number 12-2
 Vehicle information code plate 12-2
 Vehicle labeling 12-2
 Vehicle mass 12-5
 Vehicle performance 12-5
 Ventilators 8-2

W

Warning lamps 6-37

Washer
 Fluid 11-7, 12-10
 Switch 6-51
 Washing 10-3
 Waxing 10-5
 Wheel
 Covers 9-18
 Specification 12-8
 Wiper
 Rear window 6-51
 Windscreen 6-47
 Wiper blades 11-12
 Wiper deicer switch 6-53

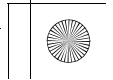
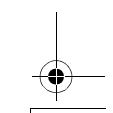
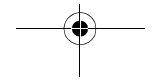
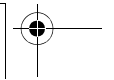
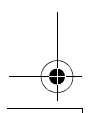
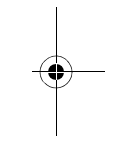
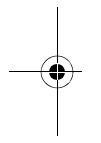
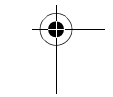
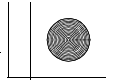
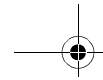
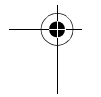
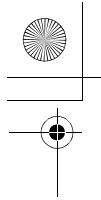

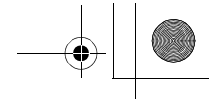

E09300103823

Information for station service

Fuel	Capacity	45 litres
	Fuel requirements	Unleaded petrol octane number 90 RON or higher Refer to the “General information” section for the fuel selection.
Engine oil	Refer to the “Maintenance” section for the selection of engine oil.	
Tyre inflation pressure	Refer to the “Maintenance” section for the tyre inflation pressure.	

