

### Rescue Sheet standard translation (Italian)

 <p>Airbag</p>	 <p>Rinforzi strutturali della carrozzeria</p>	 <p>Centralina di controllo</p>	 <p>Generatore di gas</p>
 <p>Molle a gas</p>	 <p>Batteria</p>	 <p>Protezione attiva anti-ribaltamento</p>	 <p>Tenditore della cintura di sicurezza</p>
 <p>Pretensionatore della cintura di sicurezza</p>	 <p>Serbatoio carburante</p>	 <p>Serbatoio (GPL o Metano)</p>	 <p>Valvola di sicurezza (GPL o Metano)</p>
 <p>Componenti ad alta tensione</p>	 <p>Componenti o cavi ad alta tensione</p>	 <p>Punto di disconnessione della batteria ad alta tensione</p>	 <p>Batteria ad alta tensione</p>
 <p>Sensore meccanico</p>			

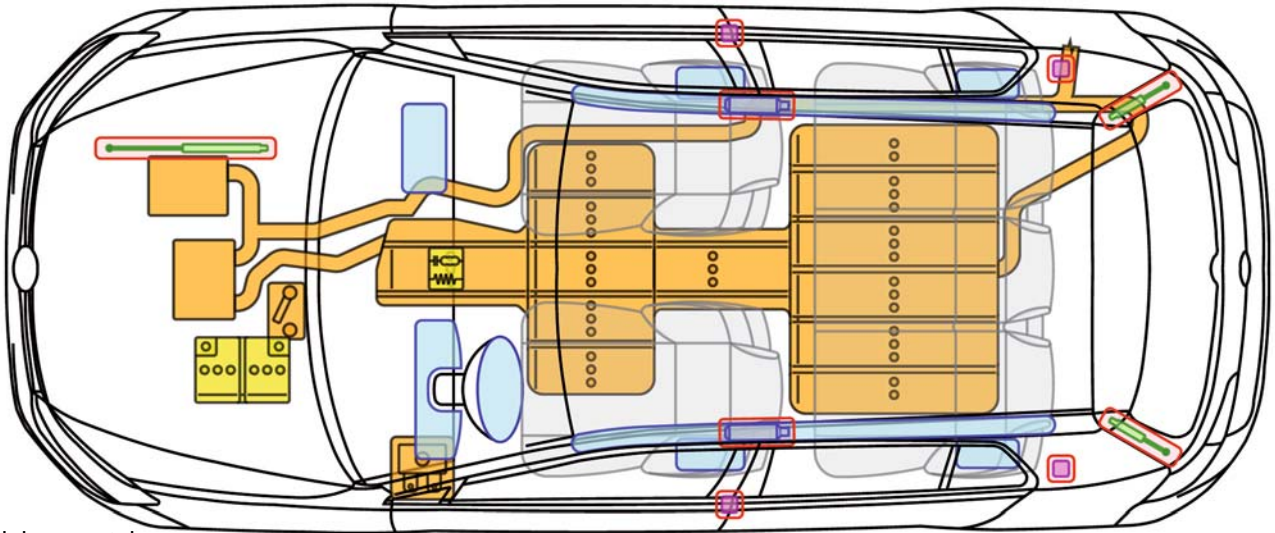

# e-Golf 7 (ab 2014)







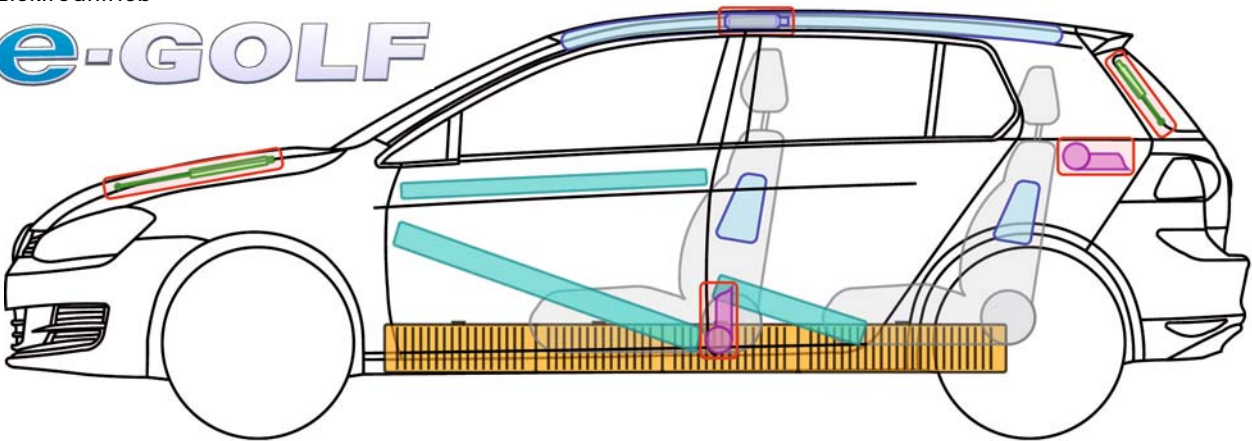







Elektroantrieb

## e-GOLF

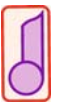

### Legende

	Airbag		Karosserie-Verstärkung		Steuergerät		Hochvolt-batterie
	Gas-generator		Sicherungs-träger		12V-Batterie		Hochvolt-komponente/-leitung
	Gurtstraffer		Gasdruck-dämpfer		Kraftstofftank		Trennstelle für Hochvolt



# e-Golf 7 (ab 2014)



## Fahrzeugidentifizierung

Designleuchten  
im Stoßfänger

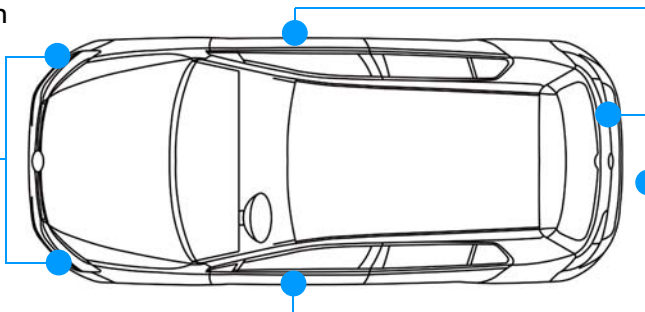

**e-GOLF**

Schriftzug auf den Türen und  
auf der Heckklappe

## Fahrzeug gegen Wegrollen sichern

1. Gangwahlhebel in Stellung „P“ bringen.
2. Feststellbremse betätigen.

## Antrieb und Hochvoltsystem deaktivieren

### Antrieb und Hochvoltsystem deaktivieren

(Zündung und Sicherungsträger im Innenraum zugänglich)



1. Zündschlüssel in „AUS-Stellung“ drehen  
und abziehen oder Start-Stop-Taste drücken.



Die passiven Sicherheitssysteme wie Airbags und Gurtstraffer sind nach Ablauf der Entladungszeit des Airbagsteuergerätes von ca. 4 Sekunden durch das Drehen des Zündschlüssels in die Stellung „AUS“ deaktiviert.

Vor Ablauf der Entladungszeit besteht eine Gefahr der Airbagauslösung aufgrund der Beschädigung des Airbagsystems.

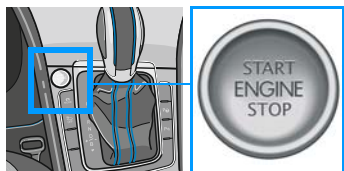

2. Ablagefach über dem Sicherungsträger der Schalttafel links entfernen.  
Gekennzeichnete Sicherung herausziehen.  
(gelbe Fahne)

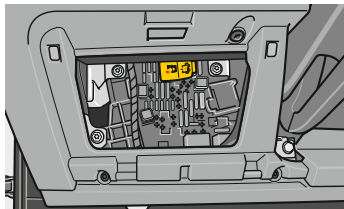

Das Hochvoltsystem ist nach dem Deaktivieren innerhalb von ca. 20 Sekunden spannungsfrei. Die passiven Sicherheitssysteme wie Airbags und Gurtstraffer sind dann deaktiviert.





## Antrieb und Hochvoltssystem deaktivieren

### Antrieb und Hochvoltssystem deaktivieren (Motorraum zugänglich)

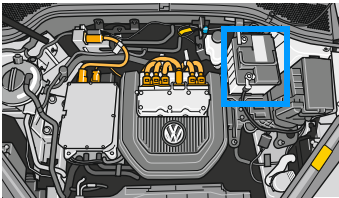

**1. 12-V-Batterie abklemmen**

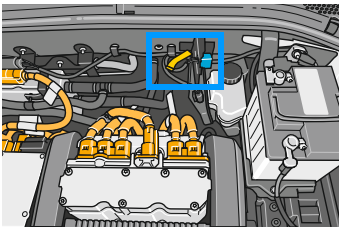

**2. Rettungstrennstelle lokalisieren**

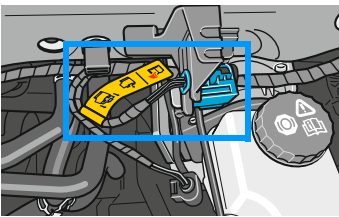

**3. Rettungstrennstelle öffnen**

Vorgehensweise ist auf dem Label beschrieben!



**Das Hochvoltssystem ist nach dem Deaktivieren innerhalb von ca. 20 Sekunden spannungsfrei. Die passiven Sicherheitssysteme wie Airbags und Gurtstraffer sind dann deaktiviert.**



## An der Ladesäule angeschlossenes Fahrzeug

**Fahrzeug entriegeln. Das Ladekabel vom Fahrzeug trennen und ggf. bei schweren Unfällen das Hochvoltssystem des Fahrzeugs deaktivieren (siehe unter „Fahrzeug deaktivieren“)!**